

5528

JVC

SERVICE MANUAL

COLOUR VIDEO MONITOR

BASIC CHASSIS

R3

TM-H140PN

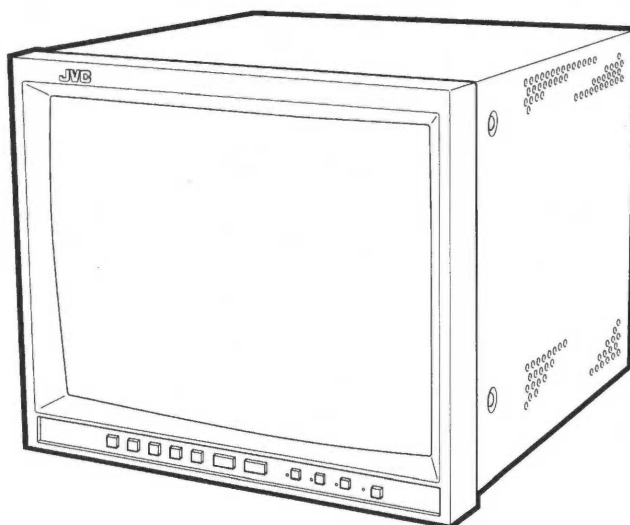

TM-H140 PN

CONTENTS

- SPECIFICATIONS 2
- ★ OPERATING INSTRUCTIONS (APPENDIX) 1-1
- SAFETY PRECAUTIONS 3
- SPECIFIC SERVICE INSTRUCTIONS 4
- SERVICE ADJUSTMENTS 9
- ★ STANDARD CIRCUIT DIAGRAM (APPENDIX) 2-1
- PARTS LIST 37

SPECIFICATIONS

Item	Content	
Colour system	PAL / NTSC 3.58	
Picture tube	36cm measured diagonally, 90° deflection, in-line gun, trio – dot type (phosphor dot - trio pitch of 0.28 mm)	
Effective screen size	280.8mm × 210.6mm (W × H) / 335.4mm (Diagonal)	
Scanning frequency	(H)15.734 kHz (NTSC) 15.625 kHz (PAL) (V)59.94 Hz (NTSC) 50Hz (PAL)	
Horizontal resolution	750TV line or more (Y/C input mode)	
Colour Temperature	6500K ; x = 0.313, y = 0.329 9300K ; x = 0.283, y = 0.297	
High Voltage	23.7kV~26.3kV	
Signal input / output		
Input Terminals	VIDEO INPUT A	BNC terminal : 1 bridge-connected output with automatic termination 1V(p-p) 75Ω (negative sync)
	VIDEO INPUT B	BNC terminal : 1 bridge-connected output with automatic termination 1V(p-p) 75Ω (negative sync)
	Y/C SEPARATE	Mini-DIN(4pin) : 1 bridge-connected output with automatic termination Y : 1.0V(p-p) 75Ω (negative sync) C (Burst) : 0.286V(p-p) 75Ω (NTSC Burst) : 0.3V(p-p) 75Ω (PAL Burst)
	AUDIO INPUT A	500mV(rms) (monaural), high-impedance, bridge connection possible
	AUDIO INPUT B	500mV(rms) (monaural), high-impedance, bridge connection possible
Audio power output	1W (Monaural)	
Speaker	8cm round × 1 8Ω	
Power requirements	230V AC, 50/60 Hz	
Power consumption	0.5A (230V, AC)	
Operation temperature	0~40°C (32~104° F)	
Operation humidity	20~80% (non-condensing)	
Dimension (W × H × D)	346mm × 310mm × 375mm	
Mass	13.4kg	

Design & specifications are subject to change without notice.

OPERATING INSTRUCTIONS

JVC

TM-H140PN COLOUR VIDEO MONITOR

COLOUR VIDEO MONITOR

INSTRUCTIONS
TM-H140PN

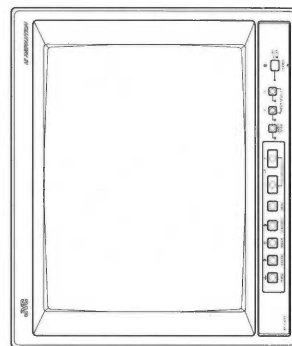

JVC

VICTOR COMPANY OF JAPAN, LIMITED

Printed in Thailand
LCT0862-001A-H
0900-KU-JMT

© 2000 VICTOR COMPANY OF JAPAN, LIMITED

Thank you for purchasing this JVC colour video monitor. Before using it, read and follow all instructions carefully to take full advantage of the monitor's capabilities.

SAFETY PRECAUTIONS

In order to prevent any fatal accidents caused by misoperation or mishandling the monitor, be fully aware of all the following precautions.

WARNINGS

To prevent fire or shock hazard, do not expose this monitor to rain or moisture. Dangerous high voltages are present inside the unit. Do not remove the back cover of the cabinet. When servicing the monitor, contrast qualified service personnel. Never try to service it yourself.

WARNING : THIS APPARATUS MUST BE EARTHED.

Machine Noise Information Ordinance 3. GSGV, January 18, 1991: The sound pressure level at the operator position is equal or less than 70 dB(A) according to ISO 7779.

Improper operations, in particular alternation of high voltage or changing the type of tube may result in x-ray emission of considerable dose. A unit altered in such a way no longer meets the standards of certification, and must therefore no longer be operated.

PRECAUTIONS

- Use only the power source specified on the unit.
- When not using this unit for a long period of time, or when cleaning it, be sure to disconnect the power plug from the AC outlet.
- Do not allow anything to rest on the power cord. And do not place this unit where people will tread on the cord. Do not overload wall outlets or power cords as this can result in a fire or electric shock.
- Avoid using this unit under the following conditions:
 - in extremely hot, cold or humid places,
 - in dusty places,
 - near appliances generating strong magnetic fields,
 - in places subject to direct sunlight,
 - in badly ventilated places,
 - in automobiles with doors closed.
- Do not cover the ventilation slots while in operation as this could obstruct the required ventilation flow.
- When dust accumulates on the screen surface, clean it with a soft cloth.
- Unplug this unit from the AC outlet and refer servicing to qualified service personnel under the following conditions:
 - when the power cord is frayed or the plug is damaged,
 - if liquid has been spilled into the unit,
 - if the unit has been dropped or the cabinet has been damaged,
 - when the unit exhibits a distinct change in performance.
- Do not attempt to service this unit yourself as opening or removing covers may expose you to dangerous voltage or other hazards. Always refer servicing to qualified service personnel.
- When replacement parts are required, have the service personnel verify in writing that the replacement parts he/she uses have the same safety characteristics as the original parts. Use of manufacturer's specified replacement parts can prevent fire, shock, or other hazards.
- Upon completion of any servicing or repair work to this unit, please ask the service personnel to perform the safety check described in the manufacturer's service literature.
- When this unit reaches the end of its useful life, improper disposal could result in a picture tube implosion. Ask qualified service personnel to dispose of this unit.

SCREEN BURN

- It is not recommended to keep a certain still image displayed on screen for a long time as well as displaying extremely bright images on screen. This may cause a burning (sticking) phenomenon on the screen of cathode-ray tube. This problem does not occur as far as displaying normal video playback motion images.

POWER CONNECTION (Only for United Kingdom-type power cord)

The plug on the United Kingdom-type power cord has a built-in fuse.

WARNING

Do not cut off the main plug from this equipment.

If the plug fitted is not suitable for the power points in your home or the cable is too short to reach a power point, then obtain an appropriate safety approved extension lead or adapter or consult your dealer.

If nonetheless the mains plug is cut off, remove the fuse and dispose of the plug immediately, to avoid a possible shock hazard by inadvertent connection to the main supply.

If a new main plug has to be fitted, then follow the instruction given below:

WARNING:
THIS APPARATUS MUST BE EARTHED.

IMPORTANT.

The wires in the mains lead on this product are coloured in accordance with the following cord:

Green-and-yellow	: Earth
Blue	: Neutral
Brown	: Live

As these colours may not correspond with the coloured making identifying the terminals in your plug, proceed as follows:

The wire which is coloured green-and-yellow must be connected to the terminal which is marked with the letter E or the safety earth symbol  or coloured green or green-and-yellow.

The wire which is coloured blue must be connected to the terminal which is marked with the letter N or coloured black.

The wire which is coloured brown must be connected to the terminal which is marked with the letter L or coloured red.

When replacing the fuse, be sure to use only a correctly rated approved type, re-fit the fuse cover.

IF IN DOUBT — CONSULT A COMPETENT ELECTRICIAN.

How To Replace The Fuse

Open the fuse compartment with the blade screwdriver, and replace the fuse.

(* An example is shown in the illustration below.)

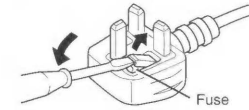

CONTENTS

SAFETY PRECAUTIONS	2
CONTROLS AND FEATURES	4
HOW TO HANDLE BASIC OPERATIONS	7
HOW TO USE THE MENU FUNCTIONS	8
HOW TO INITIALISE THE SETTING	11
BASIC CONNECTION EXAMPLE	12
TROUBLESHOOTING	14
SPECIFICATIONS	15

CONTROLS AND FEATURES

FRONT VIEW

<Front Panel>

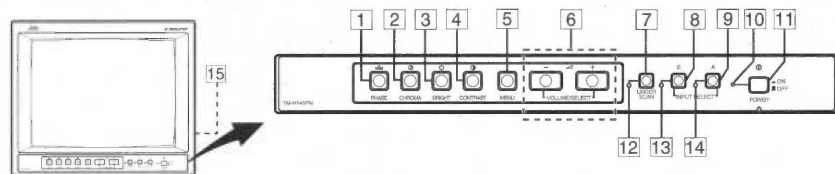

1 Phase button [PHASE]

Press this button to set the picture hue adjustment mode. Adjust the value with the VOLUME/SELECT buttons. Also used as a control button in the menu function mode.

2 Chroma button [CHROMA]

Press this button to set the picture colour density adjustment mode. Adjust the value with the VOLUME/SELECT buttons. Also used as a control button in the menu function mode.

3 Brightness button [BRIGHT]

Press this button to adjust picture brightness. Adjust the value with the VOLUME/SELECT buttons. Also used as a control button in the menu function mode.

4 Contrast button [CONTRAST]

Press this button to adjust picture contrast. Adjust the value with the VOLUME/SELECT buttons. Also used as a control button in the menu function mode.

5 Menu button [MENU]

Displays and disappears the <MENU> screen. Pressing the PHASE button with the Menu button depressed will display the <SET-UP MENU> screen.

6 Volume/Select buttons [VOLUME/SELECT - +]

Adjusts the speaker volume. Also used as a control button in the menu function mode.

7 Under Scan button [UNDER SCAN]

Reduces the screen size to display the whole screen. Press the button again to quit Under Scan.

8 Input B (VIDEO / Y/C) button [INPUT SELECT B]

Selects the video signal input to the VIDEO B terminal and the audio signal input to the AUDIO B terminal on the rear panel. When selected, the input B (VIDEO / Y/C) indicator lights.

Notes:

* The VIDEO B terminals include a video terminal (BNC connector) and a Y/C terminal (mini-DIN 4-pin connector). The Y/C (S-video) terminal is given priority.

9 Input A (VIDEO) button [INPUT SELECT A]

Selects the video signal input to the VIDEO A terminal and the audio signal input to the AUDIO A terminal on the rear panel. When selected, the input A (VIDEO) indicator lights.

10 Power indicator

Lights in green when the power is ON.
Lit : When the power is on.
Unlit : When the power is off.

11 Power switch [POWER]

Press this switch to turn the power on or off.
- ON : Power is turned on.
- OFF : Power is turned off.

12 Under Scan indicator

Lights in green when UNDER SCAN is selected.

13 Input B (VIDEO / Y/C) indicator

Lights in green when Input B (VIDEO / Y/C) is selected.

14 Input A (VIDEO) indicator

Lights in green when Input A (VIDEO) is selected.

15 Speaker

A built-in speaker is located inside the right side panel when the monitor is viewed from the front.

REAR VIEW

<Rear Panel>

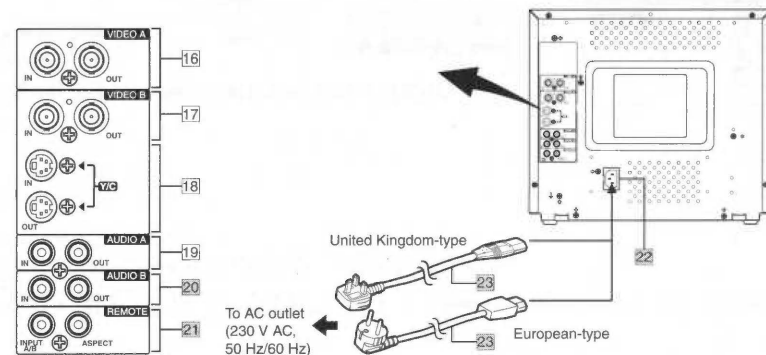

16 Video A terminals [VIDEO A IN/OUT]

Video signal input (IN) and output (OUT) terminals. The output terminal is bridge-connected.

IN : Video signal input terminal

OUT : Bridge-connected video signal output terminal

Notes:

* For corresponding audio signals, use the AUDIO A terminals .

* Also refer to BASIC CONNECTION EXAMPLE on page 12.

17 Video B terminals [VIDEO B IN/OUT]

Video signal input (IN) and output (OUT) terminals. The output terminal is bridge-connected.

IN : Video signal input terminal

OUT : Bridge-connected video signal output terminal

Notes:

* For corresponding audio signals, use the AUDIO B terminals .

* When both VIDEO B terminals are connected (input) at the same time, the Y/C terminal is given priority.

* Also refer to BASIC CONNECTION EXAMPLE on page 12.

18 Video B (Y/C) terminals [VIDEO B Y/C IN/OUT]

Y/C (S-Video) signal input (IN) and output (OUT) terminals.

The output terminal is bridge-connected.

IN : Y/C-separated (S-video) signal input terminal

OUT : Bridge-connected Y/C-separated (S-video) signal output terminal

Notes:

* For corresponding audio signals, use the AUDIO B terminals .

* When both VIDEO B terminals are connected (input) at the same time, the Y/C terminal is given priority.

* Also refer to BASIC CONNECTION EXAMPLE on page 12.

19 Audio A terminals [AUDIO A IN/OUT]

Input (IN) and output (OUT) terminals for the audio signal corresponding to the VIDEO A terminals .

The output terminal is bridge-connected.

IN : Audio signal input terminal

OUT : Bridge-connected audio signal output terminal

Notes:

* For corresponding video signals, use the VIDEO A terminal .

* Also refer to BASIC CONNECTION EXAMPLE on page 12.

CONTROLS AND FEATURES (cont'd)

REAR VIEW

<Rear Panel>

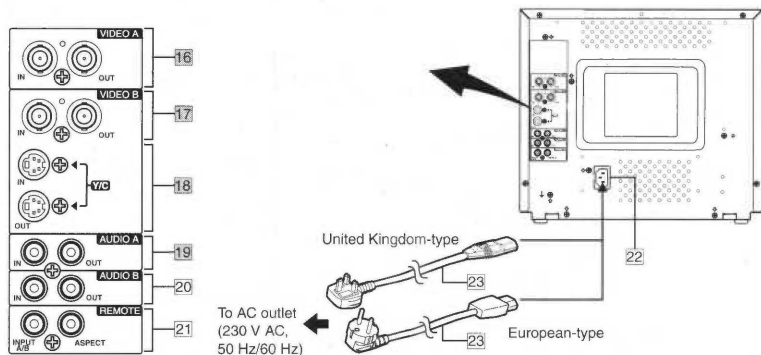

20 Audio B terminals [AUDIO B IN/OUT]

Input (IN) and output (OUT) terminals for the audio signals corresponding to the VIDEO B terminals [17] or VIDEO B (Y/C) terminals [18]. The output terminal is bridge-connected.

IN : Audio signal input terminal

OUT : Bridge-connected audio signal output terminal

Notes:

- * For corresponding video signals, use the VIDEO B terminals [17] or VIDEO B (Y/C) terminals [18].
- * Also refer to BASIC CONNECTION EXAMPLE on pages 12 and 13.

21 Remote terminals

[REMOTE INPUT A/B, ASPECT]

Remote terminals for external control. Selecting INPUT A or INPUT B and the ASPECT RATIO is available via external control. External control is set in the <SET-UP MENU> screen.

To use external control, you must build a switch cable and connect it to the REMOTE terminals.

External control functions	External control switch	
	Open circuit (open)	Closed circuit (short)
ASPECT RATIO	4-3 (4:3)	16-9 (16:9)
INPUT A/B	INPUT A	INPUT B

Notes:

- Also refer to BASIC CONNECTION EXAMPLE on pages 12 and 13.

22 AC inlet [AC IN]

Power input connector. Connect the provided AC power cord [23] to an AC outlet (230 V AC, 50 Hz/60 Hz).

23 Power cord

Connects the provided power cord (230 V AC, 50 Hz/60 Hz) to the AC IN connector.

Caution:

This monitor includes two power cords: one with a United Kingdom-type plug and the other with a European-type plug. The plug on the United Kingdom-type power cord has a built-in fuse. Be sure to use the proper power cord for the AC outlet in your country. If neither can be used, please contact your dealer or qualified service personnel for the correct power cord.

HOW TO HANDLE BASIC OPERATIONS

BASIC OPERATION

1. Press the POWER switch to turn on the power.



- ON : Power turns ON. (Power indicator: lit)
- OFF : Power turns OFF. (Power indicator: unlit)

2. Press the INPUT SELECT buttons to choose input.

Select video/audio signals input to terminals on the rear panel. The selected INPUT SELECT indicator lights in green.

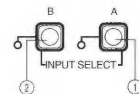

INPUT SELECT button	Terminals on the rear panel	
	Video signal input	Audio signal input
① Input A (VIDEO)	VIDEO A terminal	AUDIO A terminal
② Input B (VIDEO / Y/C)	VIDEO B terminal	AUDIO B terminal
	VIDEO B (Y/C) terminal	

* When both VIDEO B terminals are connected (input) at the same time, the Y/C terminal is given priority.

3. Press the VOLUME/SELECT buttons to adjust the speaker volume.



Press this button to display the speaker volume level on the screen.

+ : The Built-in speaker volume is increased. (00 → 50)

- : The Built-in speaker volume is decreased. (50 → 00)

* Screen indication will disappear about 10 seconds after operating.

PICTURE ADJUSTMENT

1. Press select buttons corresponding to the item you want to adjust.

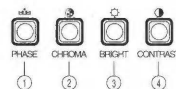

The item you select is displayed on the screen.

- ① PHASE (☉) : Phase control
- ② CHROMA (⦿) : Chroma control
- ③ BRIGHT (☀) : Brightness control
- ④ CONTRAST (◐) : Contrast control

2. Adjust with the VOLUME/SELECT buttons.



Items	VOLUME/SELECT button	
	-	+
PHASE (Phase)	reddish	greenish
CHROMA (Chroma)	lighter	deeper
BRIGHT (Brightness)	darker	brighter
CONTRAST (Contrast)	lower	higher

* Screen indication will disappear about 10 seconds after operating.

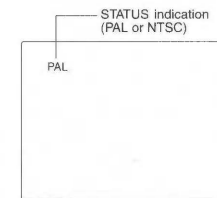

About the STATUS indication

- With the COLOR SYSTEM setting set to AUTO mode, when you turn on the power or select inputs, the colour system indication appears for about 3 seconds on the screen while PAL or NTSC signals are being detected. It does not appear when receiving a B/W signal or when no signal is input. Refer to page 8 for more information about COLOR SYSTEM setting and page 9 for more information about STATUS indication setting.

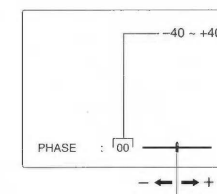
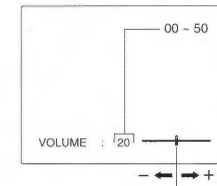

Notes:

- Phase control is effective only in the NTSC colour system mode.
- Chroma control is not effective when receiving B/W or when no signal is input. (Except when a component signal is input.)
- When CHROMA is adjusted to "-40," the picture becomes less colourful.
- "NO EFFECT" is displayed (for about 3 seconds) when your selected function has no effect.

HOW TO USE THE MENU FUNCTIONS

DISPLAY AND SELECTION IN THE <MENU> SCREEN MODE (SETTING)

You can set the following menu items. Set them depending on your needs.

- SHARPNESS
- COLOR TEMP.
- COLOR SYSTEM
- ASPECT RATIO

1. Press the MENU button.



The <MENU> screen is displayed.
* The screen automatically disappears when no operation is performed after about 5 minutes.

2. Press the PHASE () or CHROMA () button to select MENU items.



A selection mark (▶) is put next to the selected item.

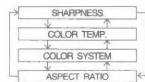

Front panel button	Function displayed	Contents
PHASE ()	▼	Forward selection mark (▶)
CHROMA ()	▲	Reverse selection mark (▶)

3. Press the VOLUME/SELECT buttons to set.



Front panel button	Function displayed	Contents
VOLUME/SELECT (+)	+	Increase (to max. value)
	▶	Forward the setting value
VOLUME/SELECT (-)	-	Decrease (to min. value)
	◀	Reverse the setting value

Menu items	Purpose	Setting range
SHARPNESS	Picture sharpness	00 ↔ +1 ↔ ↔ ↔ ↔ +39 ↔ +40
COLOR TEMP.	Colour temperature of white balance	9300 ↔ 6500
COLOR SYSTEM	Colour system	AUTO ↔ NTSC ↔ AUTO ↔ PAL
ASPECT RATIO	Aspect ratio	4 - 3 ↔ 16 - 9

4. If you want to set the other menu items, repeat procedures 2 and 3.

5. Press the MENU button to quit.



Front panel button	Function displayed	Contents
MENU	EXIT	Quit (or Release) the <MENU> screen

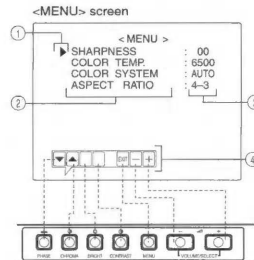

<Front panel buttons>

- Selection mark (▶): Indicates the menu item you select.
- Menu item: Menu items you can select.
- Setting display: Indicates the current settings (value).
- Function display: The functions of the front panel buttons (7 buttons on the left) correspond to the function displayed.

Function displayed	Contents
▼	Forward the menu item.
▲	Reverse the menu item.
-	Lower the adjustment value. (to the minimum)
+	Raise the adjustment value. (to the maximum)
▶	Forward the setting value.
◀	Reverse the setting value.
EXIT	Exits the <MENU> screen.

Notes:

- When the screen aspect ratio is set to 16 - 9 (16:9) in ASPECT RATIO, the picture will be vertically reduced.

DISPLAY AND SELECTIONS IN THE <SET-UP MENU> MODE (SETTING)

You can set the following set-up menu items.

- H. POSITION
- V. POSITION
- WHITE BALANCE
- CONTROL LOCK
- STATUS DISPLAY
- INPUT REMOTE
- ASPECT REMOTE

Notes:

- Parameters for H. POSITION and V. POSITION can be set separately depending on the video input (Input A (VIDEO) or Input B (VIDEO / Y/C)) selected by the input select buttons on the front panel. Select the required video input with the input select buttons on the front panel in advance.
- WHITE BALANCE can be set individually at 6500 or 9300 for the colour temperature value. Set COLOR TEMP. to the value 6500 or 9300 in the <MENU> screen in advance.

1. While pressing the MENU button, press the PHASE () button.



The <SET-UP MENU> screen is displayed.
* The screen automatically disappears when no operation is performed after about 5 minutes.

2. Press the PHASE () or CHROMA () button to select the desired menu item.



A selection mark (▶) is put next to the selected item.

Front panel button	Function displayed	Contents
PHASE ()	▼	Forward selection mark (▶)
CHROMA ()	▲	Reverse selection mark (▶)

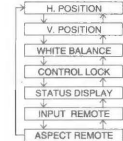

3. Press the VOLUME/SELECT buttons to set.



Front panel button	Function displayed	Contents
* VOLUME/SELECT (+)	+	Increase (to max. value)
	▶	Forward the setting value
VOLUME/SELECT (-)	-	Decrease (to min. value)
	◀	Reverse the setting value
DRV		Selects DRIVE setting screen
CUTO		Selects CUT OFF adjustment.
R		Adjusts red signal level.
G		Adjusts green signal level.
B		Adjusts blue signal level.
DISP		Turns the ON-SCREEN display on or off. (This function is effective only in the DRIVE or CUT OFF adjustment mode.)

Notes:

- For the WHITE BALANCE setting, select the CUT OFF or DRIVE setting screen, then select the buttons (PHASE/CHROMA/BRIGHT) corresponding to the function indicated (R/G/B).
- Press the EXIT (MENU) button to return to the <SET-UP MENU> screen.

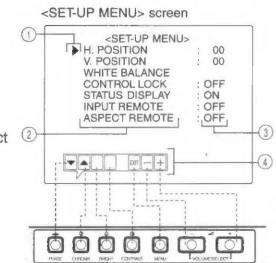

<Front panel buttons>

- Selection mark (▶): Indicates the menu item you select.
- Menu item: Menu items you can select.
- Setting display: Indicates the current settings (value).
- Function display: The functions of the front panel buttons (7 buttons on the left) correspond to the function displayed.

Function displayed	Contents
▼	Forward the menu item.
▲	Reverse the menu item.
-	Lower the adjustment value. (to the minimum)
+	Raise the adjustment value. (to the maximum)
▶	Forward the setting value.
◀	Reverse the setting value.
EXIT	Exit the <SET-UP MENU> screen. (release)
DRV	Selects DRV adjustment.
CUTO	Selects CUT OFF adjustment.
R	Adjusts red signal level.
G	Adjusts green signal level.
B	Adjusts blue signal level.
DISP	Turns the ON-SCREEN display on or off. (This function is effective only in the DRIVE or CUT OFF adjustment mode.)

HOW TO USE THE MENU FUNCTIONS (cont'd)

Set-up menu items		Purpose	Settings
H. POSITION		Adjusts the horizontal position of the screen (+: Horizontal position shifts to the right/ -: Horizontal position shifts to the left)	-05 ↔ -04 ↔ ↔ -01 ↔ 00 ↔ +01 ↔ ↔ +04 ↔ +05
V. POSITION		Adjusts the vertical position on the screen (+: Vertical position moves down/ -: Vertical position moves up)	-05 ↔ -04 ↔ ↔ -01 ↔ 00 ↔ +01 ↔ ↔ +04 ↔ +05
WHITE BALANCE		Adjusts the white balance	Selects DRIVE (DRV) or CUT OFF (CUTO) adjustment. Screen setting is changed to the selected setting mode. Select R/G/B buttons corresponding to the function display to adjust.
DRIVE	R.DRIVE	Adjusts red level	-20 ↔ -19 ↔ ↔ -01 ↔ 00 ↔ +01 ↔ ↔ +19 ↔ +20
	B.DRIVE	Adjusts blue level	-20 ↔ -19 ↔ ↔ -01 ↔ 00 ↔ +01 ↔ ↔ +19 ↔ +20
CUT OFF	R. CUT OFF	Adjusts red cut off	-20 ↔ -19 ↔ ↔ -01 ↔ 00 ↔ +01 ↔ ↔ +19 ↔ +20
	G. CUT OFF	Adjusts green cut off	-20 ↔ -19 ↔ ↔ -01 ↔ 00 ↔ +01 ↔ ↔ +19 ↔ +20
	B. CUT OFF	Adjusts blue cut off	-20 ↔ -19 ↔ ↔ -01 ↔ 00 ↔ +01 ↔ ↔ +19 ↔ +20
CONTROL LOCK		Sets the operation buttons on the front panel to control lock mode	OFF ↔ ON
STATUS DISPLAY		Sets the status display of the colour system	ON ↔ OFF
INPUT REMOTE		Sets external control of input selection (INPUT A/B)	OFF ↔ A/B
ASPECT REMOTE		Sets external control of the aspect ratio	OFF ↔ ON

4. To set the other set-up menu items, repeat the procedures 2 and 3.

5. Press the MENU button to quit.



Front panel button	Function displayed	Contents
MENU	EXIT	Quit (or Release) the <MENU> screen

Notes:

- When the CONTROL LOCK function is set to ON, pressing operation buttons on the front panel will display the message "CONTROL LOCK ON!" on the screen for about 3 seconds.
- The CONTROL LOCK function is maintained even when the power is turned off.
- To turn off the CONTROL LOCK function, while holding the MENU button press the PHASE button. Then set the CONTROL LOCK function to OFF.
- Even when the CONTROL LOCK function is set to ON, the following operations are available:
 - Power Switch operation
 - Volume control with the VOLUME/SELECT buttons
 - External control when INPUT REMOTE or ASPECT REMOTE is valid
 - Display or disappear of the <SET-UP MENU> screen.
- The STATUS DISPLAY function can be set to display (ON) or not display (OFF) the present colour system when the power is turned on or the input signal is changed. Refer to page 7 for more information.
- When the INPUT REMOTE function is valid (A/B), pressing the Input A or Input B buttons will display the message "REMOTE ON!" on the screen for about 3 seconds.
- The INPUT REMOTE function is valid (A/B) after quitting the <SET-UP MENU> screen.

HOW TO INITIALISE THE SETTING

SCREEN DISPLAY AND SELECTIONS IN THE <SET-UP MENU> RESET MODE

You can set <MENU> and <SET-UP MENU> screen items, picture adjustment items and the volume level to their factory-set (initial) values.

<SET-UP MENU> RESET screen

```

<SET-UP MENU> RESET

Are you sure?
"Yes" then <CONTRAST>
"No" then << or >>
  
```

1. Press the Power (ⓐ) switch to turn the power OFF (■).



2. While pressing both MENU button and PHASE (ⓑ) button, press the Power (ⓐ) switch to turn the power ON (■).



The <SET-UP MENU> RESET screen is displayed. * The screen automatically disappears when no operation is performed after about 5 minutes.

Note:

- The <SET-UP MENU> RESET screen will not be displayed if the MENU or PHASE buttons are pressed for a very short time. Keep pressing them until the display screen appears.

3. Setting

- Initialisation is required.



Press the CONTRAST (ⓓ) button. * Initialisation is completed, and the <SET-UP MENU> RESET screen disappears.

- Initialisation is not required.



Press the VOLUME/SELECT [+] or [-] button. * Initialisation is aborted, and the <SET-UP MENU> RESET screen disappears.

Initial settings

Sorts	Functions (Items)	Initialisation (setting)
MENU screen	SHARPNESS	00
	COLOR TEMP.	6500
	COLOR SYSTEM	AUTO
<SET-UP MENU> screen	ASPECT RATIO	4-3
	H. POSITION	00
	V. POSITION	00
	WHITE BALANCE	
	R. CUT OFF	00
	G. CUT OFF	00
	B. CUT OFF	00
	R. DRIVE	00
	B. DRIVE	00
	CONTROL LOCK	OFF
STATUS DISPLAY	ON	
INPUT REMOTE	OFF	
ASPECT REMOTE	OFF	
Picture adjustment	PHASE	00
	CHROMA	00
	CONTRAST	00
	BRIGHT	00
Volume	VOLUME	20

ENGLISH

BASIC CONNECTION EXAMPLE

Notes:

- Before connecting your system, make sure that all units are turned off.
- The illustration below shows some examples of different connections. Terminal connections may differ depending on the component connected. Be sure to refer to the instructions provided with the unit(s) you are connecting.
- Each pair of input (IN) and output (OUT) terminals are bridge-connected.
- If you're not connecting any equipment to a bridged output (OUT) terminal, be sure not to connect any other cables to the bridged output (OUT) terminal as this will cause the terminating resistance switch to open (auto terminate function).
- When making a bridge connection, connect the input (IN) and output (OUT) terminals on the monitor to separate video components. (For example, if both terminals are connected to the same VCR, resonance may occur except during playback. This is caused by the same video signal "looping" between the VCRs, and is not a malfunction.)
- Select the video input (INPUT A (VIDEO) or INPUT B (VIDEO / Y/C)) with the INPUT SELECT buttons on the front panel. When both VIDEO B terminals are connected (input) at the same time, the Y/C terminal is given priority.
- The ASPECT RATIO or INPUT A/B settings can be controlled via the REMOTE terminal by setting ASPECT REMOTE or INPUT REMOTE in the <SET-UP MENU> screen to valid. (Refer to pages 9 and 10.)

VIDEO A Connection Example (Select Input A (VIDEO))

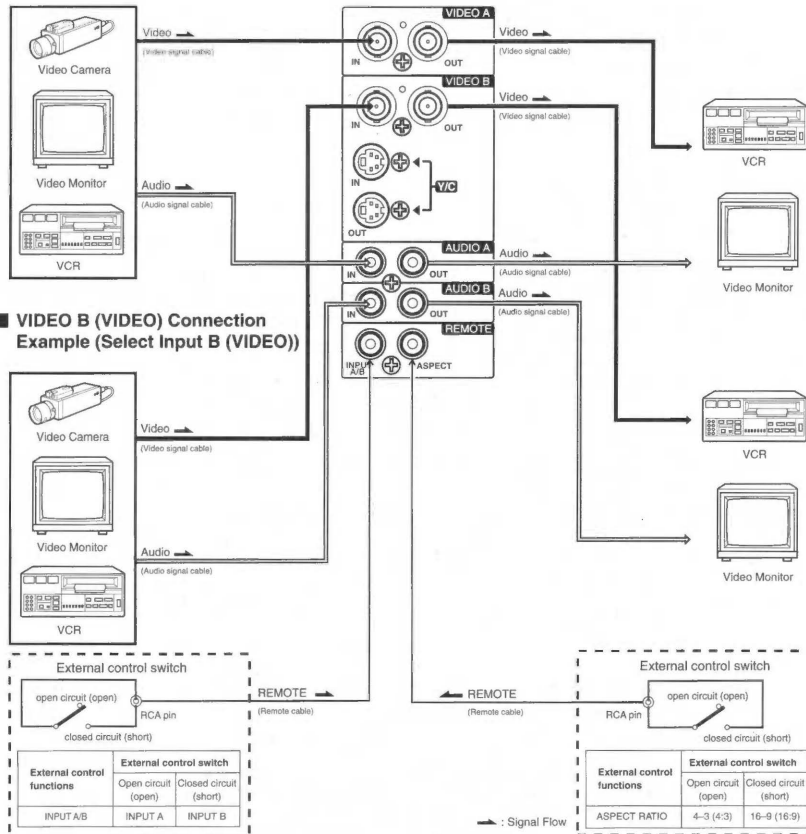

VIDEO B (VIDEO) Connection Example (Select Input B (VIDEO))

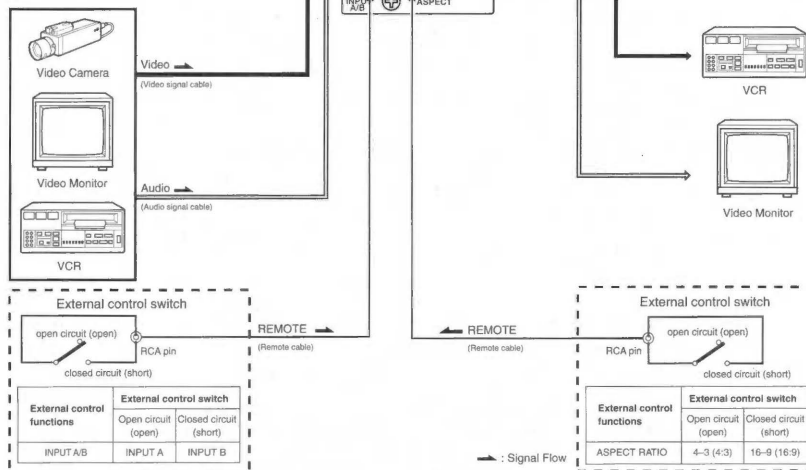

VIDEO B (Y/C) Connection Example (Select Input B (Y/C))

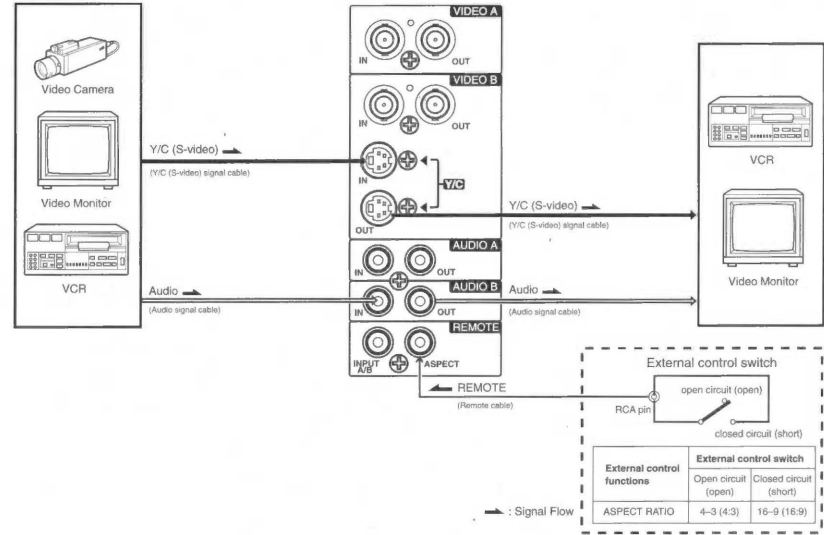

TROUBLESHOOTING

Solutions to common problems related to your monitor are described here. If none of the solutions presented here solves the problem, unplug the monitor and consult a JVC-authorized dealer or service centre for assistance.

Problems	Points to be checked	Measures (Remedy)
No power supply.	Is the power plug loosened or disconnected?	Firmly insert the power plug.
No picture with the power on.	Is the video signal output from the connected component?	Set the connected component correctly.
	Is the input signal selected properly?	Select the required video signal input with the Input select button. (See page 7.)
	Is the video cable disconnected?	Connect the video signal cable firmly. (See pages 12 and 13.)
No sound.	Is the audio signal output from the connected component?	Set the connected component correctly.
	Is the volume output set to minimum?	Adjust the speaker volume with the VOLUME/SELECT button. (See page 7.)
	Is the audio cable disconnected?	Connect the audio signal cable firmly. (See pages 12 and 13.)
Shaking picture.	Is the monitor close to a device generating a strong magnetic field?	Move the device away from the monitor until the picture stabilises.
No colours, wrong colour, or dark picture.	Is the colour system selected properly?	Set COLOR SYSTEM in the <MENU> screen to AUTO. (See page 8.)
	Has the picture control setting (CONTRAST, BRIGHT, CHROMA or PHASE) been changed?	Set each picture control to the standard setting. (See page 7.)
Unnatural, irregularly coloured, or distorted picture.	Is the monitor close to a speaker, magnet or any other device generating a strong magnetic field?	Move the device away from the monitor and turn the monitor's power off. Wait at least 30 minutes, then turn the power on again.
Dark stripes appear at the top and bottom of the screen, picture vertically squeezed.	Is the aspect ratio set to 16:9?	Set ASPECT RATIO in the <MENU> screen to [4 : 3 (4 - 3)]. (See page 8.) When controlling externally, ASPECT RATIO should be set to [4 : 3 (4 - 3)]. (See pages 12 and 13.)
The overall picture size is too small.	Has the UNDER SCAN button been pressed so the UNDER SCAN indicator lights?	Press the UNDER SCAN button to turn off the indicator. (See page 4.)
Function buttons on the front panel do not function.	Has control of the buttons been locked? (Has the CONTROL LOCK function been set to ON?)	Set CONTROL LOCK in the <SET-UP MENU> screen to OFF. (See pages 9 and 10.)
The INPUT SELECT buttons do not function.	Is input selection under external control? (Has the INPUT REMOTE function been set to valid (A/B)?)	Set INPUT REMOTE in the <SET-UP MENU> screen to OFF. (See pages 9 and 10.)

The following are not malfunctions:

- When a bright still image (such as a white cloth) is displayed for a long period, it may appear to be coloured. This is due to the structure of the cathode ray tube and will be deleted when another image is displayed.
- You experience a mild electric shock when you touch the picture tube. This phenomenon is due to a normal buildup of static electricity on the CRT and is not harmful.
- The monitor emits a strange sound when the room temperature changes suddenly. This is only a problem if an abnormality appears on the screen as well.
- If two or more monitors are operated next to each other, their images may shake or be distorted. This phenomenon is due to mutual interference; it is not a malfunction. Move the monitors away from each other until the interference disappears or turn the power off on any monitor that is not being used.

SPECIFICATIONS

■ Type	: Colour video monitor	■ Audio power output	: 1 W (monaural)
■ Colour system	: PAL, NTSC (3.58)	■ Built-in speaker	: 8 cm round x 1 impedance of 8 Ω
■ Picture tube	: 36 cm measured diagonally, 90° deflection, in-line gun, trio-dot type (phosphor dot-trio pitch 0.28 mm)	■ Environmental conditions	: Operation temperature: 0 °C - 40 °C Operation humidity: 20 % - 80 % (non-condensing)
■ Effective screen size	: Width 280.8 mm Height 210.6 mm Diagonal 335.4 mm	■ Power requirements	: 230 V AC, 50 Hz/ 60 Hz
■ Scanning frequency	: (H) 15.734 kHz (NTSC) 15.625 kHz (PAL) (V) 59.94 Hz (NTSC) 50 Hz (PAL)	■ Power consumption	: 0.5 A (230 V AC)
■ Horizontal resolution	: 750 TV lines or more (Y/C input mode)	■ Dimensions	: Width 346 mm Height 310 mm Depth 375 mm
■ Input terminals		■ Weight	: 13.4 kg
VIDEO A	: Composite video: 1 line, BNC connector x 2, 1 V(p-p), 75 Ω, negative sync (bridge connection possible, auto termination)	■ Accessory	: AC power cord (2 m) x 2
VIDEO B	: Composite video: 1 line, BNC connector x 2, 1 V(p-p), 75 Ω, negative sync (bridge connection possible, auto termination) Y/C-separated: 1 line, mini-DIN 4-pin connector x 2 Y: 1.0 V(p-p), 75 Ω C (BURST): 0.286 V(p-p), 75 Ω (NTSC) 0.3 V(p-p), 75 Ω (PAL) (bridge connection possible, auto termination)		
AUDIO A	: 1 line (monaural), RCA pin x 2 0.5 V(rms), high-impedance (bridge connection possible)		
AUDIO B	: 1 line (monaural), RCA pin x 2 0.5 V(rms), high-impedance (bridge connection possible)		
REMOTE INPUT A/B	: 1 line, RCA pin x 1		
REMOTE ASPECT	: 1 line, RCA pin x 1		

* Illustrations used in this manual are for explanatory purposes only. The appearance of the actual product may differ slightly.

* Dimensions and weight are approximate.

* E. & O. E. Design and specifications subject to change without notice.

SAFETY PRECAUTIONS

- The design of this product contains special hardware, many circuits and components specially for safety purposes. For continued protection, no changes should be made to the original design unless authorized in writing by the manufacturer. Replacement parts must be identical to those used in the original circuits. Service should be performed by qualified personnel only.
- Alterations of the design or circuitry of the products should not be made. Any design alterations or additions will void the manufacturer's warranty and will further relieve the manufacturer of responsibility for personal injury or property damage resulting therefrom.
- Many electrical and mechanical parts in the products have special safety-related characteristics. These characteristics are often not evident from visual inspection nor can the protection afforded by them necessarily be obtained by using replacement components rated for higher voltage, wattage, etc. Replacement parts which have these special safety characteristics are identified in the parts list of Service manual. **Electrical components having such features are identified by shading on the schematics and by (Δ) on the parts list in Service manual.** The use of a substitute replacement which does not have the same safety characteristics as the recommended replacement part shown in the parts list of Service manual may cause shock, fire, or other hazards.
- Don't short between the LIVE side ground and ISOLATED (NEUTRAL) side ground or EARTH side ground when repairing.**
Some model's power circuit is partly different in the GND. The difference of the GND is shown by the LIVE : (⊥) side GND, the ISOLATED(NEUTRAL) : (⌚) side GND and EARTH : (⊕) side GND. Don't short between the LIVE side GND and ISOLATED(NEUTRAL) side GND or EARTH side GND and never measure with a measuring apparatus (oscilloscope etc.) the LIVE side GND and ISOLATED(NEUTRAL) side GND or EARTH side GND at the same time.
If above note will not be kept, a fuse or any parts will be broken.
- If any repair has been made to the chassis, it is recommended that the B1 setting should be checked or adjusted (See ADJUSTMENT OF B1 POWER SUPPLY).
- The high voltage applied to the picture tube must conform with that specified in Service manual. Excessive high voltage can cause an increase in X-Ray emission, arcing and possible component damage, therefore operation under excessive high voltage conditions should be kept to a minimum, or should be prevented. If severe arcing occurs, remove the AC power immediately and determine the cause by visual inspection (incorrect installation, cracked or melted high voltage harness, poor soldering, etc.). To maintain the proper minimum level of soft X-Ray emission, components in the high voltage circuitry including the picture tube must be the exact replacements or alternatives approved by the manufacturer of the complete product.
- Do not check high voltage by drawing an arc. Use a high voltage meter or a high voltage probe with a VTVM. Discharge the picture tube before attempting meter connection, by connecting a clip lead to the ground frame and connecting the other end of the lead through a 10kΩ 2W resistor to the anode button.
- When service is required, observe the original lead dress. Extra precaution should be given to assure correct lead dress in the high voltage circuit area. Where a short circuit has occurred, those components that indicate evidence of overheating should be replaced. Always use the manufacturer's replacement components.

9. Isolation Check

(Safety for Electrical Shock Hazard)

After re-assembling the product, always perform an isolation check on the exposed metal parts of the cabinet (antenna terminals, video/audio input and output terminals, Control knobs, metal cabinet, screw heads, earphone jack, control shafts, etc.) to be sure the product is safe to operate without danger of electrical shock.

(1) Dielectric Strength Test

The isolation between the AC primary circuit and all metal parts exposed to the user, particularly any exposed metal part having a return path to the chassis should withstand a voltage of 3000V AC (r.m.s.) for a period of one second.

(. . . Withstand a voltage of 1100V AC (r.m.s.) to an appliance rated up to 120V, and 3000V AC (r.m.s.) to an appliance rated 200V or more, for a period of one second.)

This method of test requires a test equipment not generally found in the service trade.

(2) Leakage Current Check

Plug the AC line cord directly into the AC outlet (do not use a line isolation transformer during this check.). Using a "Leakage Current Tester", measure the leakage current from each exposed metal part of the cabinet, particularly any exposed metal part having a return path to the chassis, to a known good earth ground (water pipe, etc.). Any leakage current must not exceed 0.5mA AC (r.m.s.).

However, in tropical area, this must not exceed 0.2mA AC (r.m.s.).

● Alternate Check Method

Plug the AC line cord directly into the AC outlet (do not use a line isolation transformer during this check.). Use an AC voltmeter having 1000 ohms per volt or more sensitivity in the following manner. Connect a 1500Ω 10W resistor paralleled by a 0.15μF AC-type capacitor between an exposed metal part and a known good earth ground (water pipe, etc.). Measure the AC voltage across the resistor with the AC voltmeter. Move the resistor connection to each exposed metal part, particularly any exposed metal part having a return path to the chassis, and measure the AC voltage across the resistor. Now, reverse the plug in the AC outlet and repeat each measurement. Any voltage measured must not exceed 0.75V AC (r.m.s.). This corresponds to 0.5mA AC (r.m.s.).

However, in tropical area, this must not exceed 0.3V AC (r.m.s.). This corresponds to 0.2mA AC (r.m.s.).

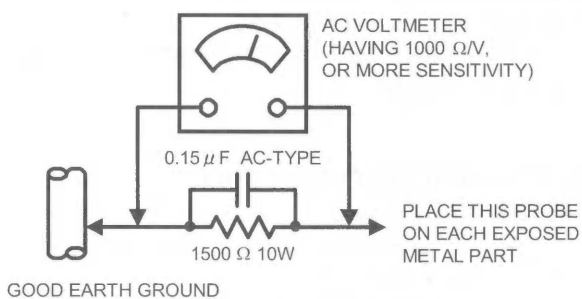

SPECIFIC SERVICE INSTRUCTIONS

DISASSEMBLY PROCEDURE

[CAUTION]

- * Even with the power switch off, some parts of the set are live. Be sure to disconnect the power cord from the AC outlet before disassembly and reassembly.

REMOVING THE TOP COVER

1. Remove the **8** screws marked (A) .
2. Slightly spread the bottom of the top cover. Shift the cover rearward and raise it upward to remove it.

REMOVING THE REAR PANEL

- After removing the top cover.
1. Remove the **7** screws marked (B) .
 2. Shift the top portion of the rear panel slightly rearward and raise it upward to remove it.

REMOVING THE TERMINAL BRACKET

- Remove the top cover and rear panel.
1. Remove the **6** screws marked (C) , **1** screw marked (D) and **1** screws marked (E) .
 2. Slightly shift the terminal bracket rearward and raise it upward to remove it.

REMOVING THE TRANSF. HOLDER

- Remove the top cover and rear panel.
1. Remove the **1** screw marked (F) and remove it.

REMOVING THE CHASSIS BASE

- Remove the top cover and rear panel.
1. Withdraw the chassis backward. If necessary, take off the wire clamp, connectors etc.

REMOVING THE BOTTOM COVER

- Remove the chassis base.
1. Place the front surface downward, then stand the bottom cover while facing it toward you.
At this time, care must be exercised not to damage the front panel and CRT surface.
 2. Remove the **2** screw marked (G) as shown in the figure pull the bottom cover upward.

CHECKING THE PW BOARD

To check the back side of the PW board.

- (1) Pull out the chassis.
- (2) Erect the chassis vertically so that you can easily check the back side of the PW board.

[CAUTION]

- * When erecting the chassis, be careful so that there will be no contacting with other PW board.

* Before turning on power, make sure that the CRT earth wire and other connectors are properly connected.

WIRE CLAMPING AND CABLE TYING

1. Be sure to clamp the wire.
2. Never remove the cable tie used for tying the wires together.
Should it be inadvertently removed, be sure to tie the wires with a new cable tie.

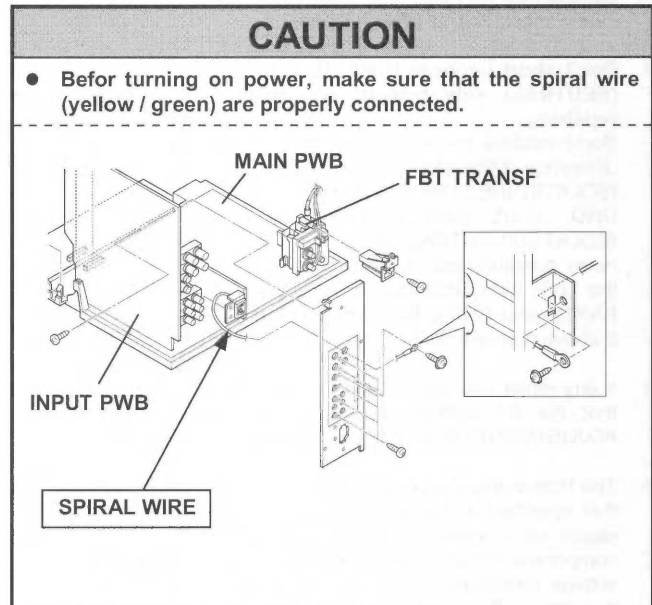

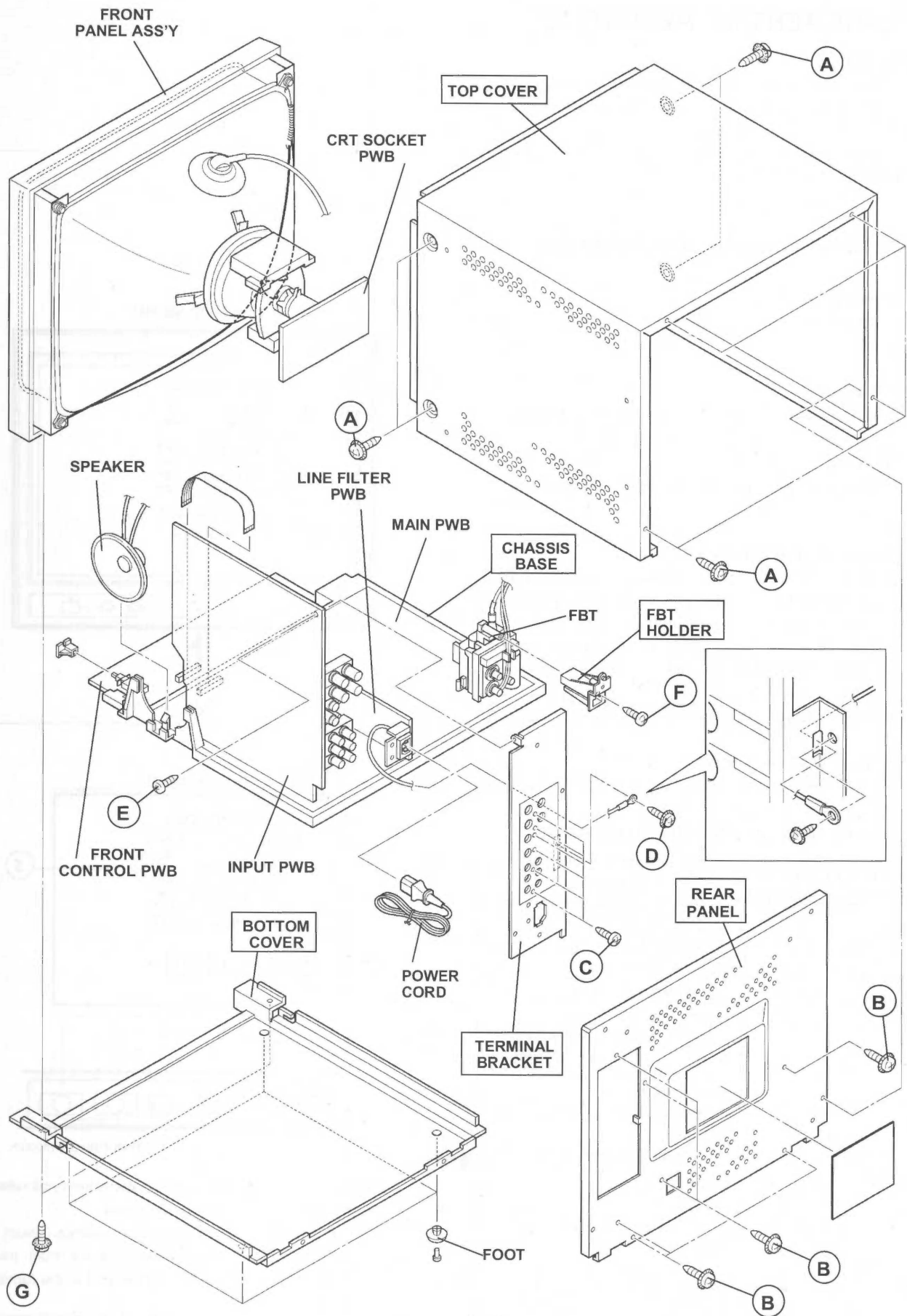

Fig.1

REPLACEMENT OF MEMORY IC

1. MEMORY IC

This model uses memory IC. In the memory IC is memorized data for correctly operating the video-chroma and deflection circuits.

When replacing memory IC, be sure to use IC written with the initial values of data.

2. PROCEDURE FOR REPLACING MEMORY IC

(1) Power off

Switch the power off and unplug the power plug from the wall outlet.

(2) Replace IC

Be sure to use memory IC written with the initial data values.

(3) Power on

Connect the power plug into the wall outlet and turn the power on.

(4) Check and set SET-UP MENU

- 1) Press the **MENU** key and the **PHASE** key simultaneously.
- 2) The SET-UP MENU screen (Fig. 1) will be displayed.
- 3) Check the setting value of the SET-UP MENU table.
If the value is different, select the setting item with the **PHASE / CHROMA** (▲ / ▼) key, and set the correct value with the **VOL / SELECT** (– / +) key.
- 4) Press the **MENU** key, and return to the normal screen.

● Setting of SERVICE MENU

Confirm the initial settings of the SERVICE MENU and reset where necessary.

For setting, refer to the **SERVICE ADJUSTMENTS**.

Front Panel button	Function Displayed	Contents
PHASE	▼	Forward the menu item.
	R	Adjusts red signal level.
CHROMA	▲	Reverse the menu item.
	G	Adjusts green signal level.
BRIGHT	B	Adjusts blue signal level.
CONTRAST	DISP	Turns the ON-SCREEN display on or off. (This function is effective only in the DRIVE or CUT OFF adjustment mode.)
MENU	EXIT	Exit the <SET-UP MENU> screen. (release)
VOLUME / SELECT (–)	–	Lower the adjustment value. (to the minimum)
	◀	Reverse the setting value.
	DRV	Select DRV adjustment.
VOLUME / SELECT (+)	+	Raise the adjustment value. (to the maximum)
	▶	Forward the setting value.
	CUTO	Selects CUT OFF adjustment.

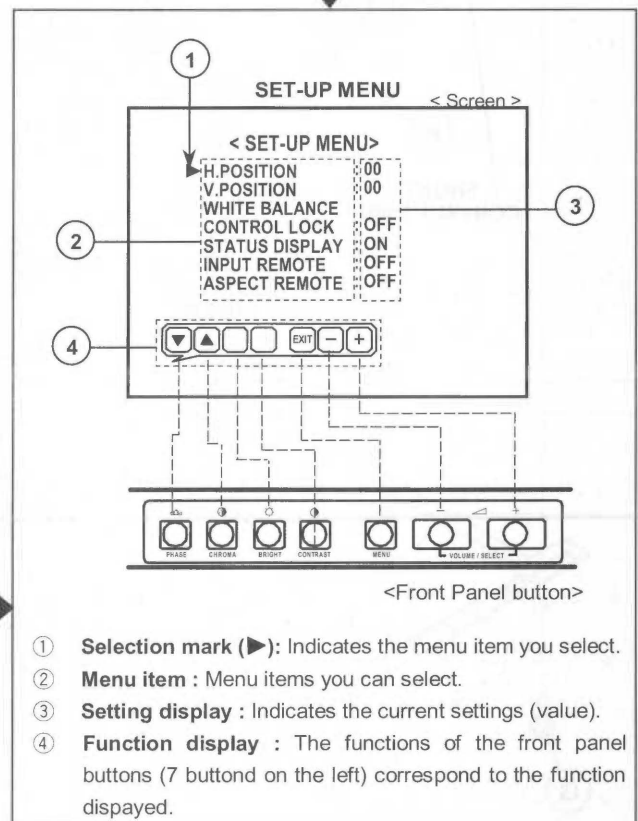
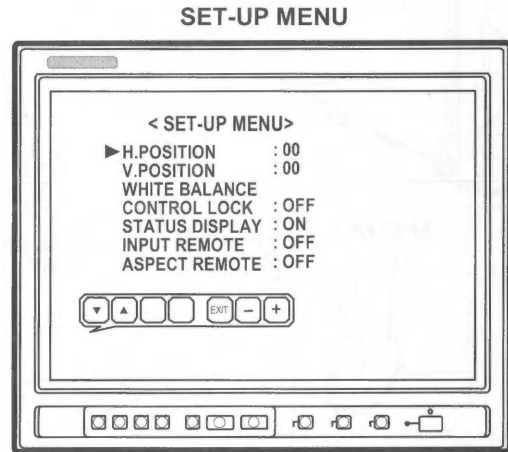

Fig. 1

INITIAL SETTING OF THE SET-UP MENU TABLE

Setting item	Setting content / Range	Initial setting	
H. POSITION	-05 ~ +05	00	
V. POSITION	-05 ~ +05	00	
WHITE BALANCE	CUTOFF (R / G / B)	-20 ~ +20	00
	DRIVE (R / B)	-20 ~ +20	00
CONTROL LOCK	<input type="checkbox"/> ON → <input type="checkbox"/> OFF	OFF	
STATUS DISPLAY	<input type="checkbox"/> ON → <input type="checkbox"/> OFF	ON	
INPUT REMOTE	<input type="checkbox"/> OFF → <input type="checkbox"/> A / B	OFF	
ASPECT REMOTE	<input type="checkbox"/> OFF → <input type="checkbox"/> ON	OFF	

INITIAL SETTING OF THE MENU SCREEN TABLE

Setting item	Setting content / Range	Initial setting
SHARPNESS	00 ~ +40	00
COLOUR TEMP.	<input type="checkbox"/> 9300 → <input type="checkbox"/> 6500	6500
COLOUR SYSTEM	<input type="checkbox"/> AUTO → <input type="checkbox"/> NTSC → <input type="checkbox"/> AUTO → <input type="checkbox"/> PAL	AUTO
ASPECT RATIO	<input type="checkbox"/> 4-3 → <input type="checkbox"/> 16-9	4-3

INITIAL SETTING OF FRONT PANEL CONTROLS

Control item	Initial setting
INPUT SELECT	A
UNDER SCAN	OFF
CONTRAST	00
BRIGHT	00
CHROMA	00
PHASE	00
VOLUME	20

BLOCK SELECT ADJUSTMENT ITEM

1.SIGNAL BLOCK

SERVICE Number	INPUT SIGNAL	CONTENTS
S01	VIDEO	BRIGHT
S02		CONTRAST
S03		CHROMA(PAL)
S04		CHROMA(NTSC)
S05		PHASE(NTSC)
S06	—————	BRIGHT(under scan)
S07	—————	CONT.(under scan)
S08	VIDEO	PHASE(PAL)
S09		CONT. TRACKING

3.DEFLECTION BLOCK

SERVICE Number	SCAN SIZE ASPECT RATIO	VERTICAL FREQUENCY	CONTENTS
D01	NORMAL	50Hz	HORIZONTAL CENTER
D02			HORIZONTAL SIZE
D03			VERTICAL CENTER
D04			VERTICAL SIZE
D05			VERTICAL LINEARITY
D06			VERTICAL S-CORRECTION
D07			E-W PARABORA
D08			E-W CORNER
* In addition to the ones listed above, the following DEF. BLOCK are also available. DA1 ~ DA8 (Normal / 60Hz), DB1 ~ DB8 (16:9 / 50Hz) DC1 ~ DC8 (16:9 / 60Hz) DD1 ~ DD8 (UNDER SCAN,4:3 / 50Hz) DE1 ~ DE8 (UNDER SCAN,4:3 / 60Hz) DF7, DF8 (UNDER SCAN,16:9 / 50Hz) DG7, DG8 (UNDER SCAN,16:9 / 60Hz)			

2.WHITE BALANCE

SERVICE Number	INPUT SIGNAL	CONTENTS
W01	VIDEO	R. CUTOFF
W02		G. CUTOFF
W03		B. CUTOFF
W04		R. DRIVE (6500)
W05		B. DRIVE(6500)
W06		R. DRIVE (9300)
W07		B. DRIVE (9300)
W08	—————	R. CUTOFF (UNDER SCAN)
W09	—————	G. CUTOFF (UNDER SCAN)
W10	—————	B. CUTOFF (UNDER SCAN)

4.CONTROL BLOCK (This is a fixed type Don't adjust it.)

SERVICE Number	ITEM	TYPE
C01	● DESTINATION 000:JAPAN/001:EUROPE 002~011: Undefine	(Do not adjust) FIXED
C02	BRIGHT POINT	UPPER ↑
C03		LOWER ↑
C04	CONTRAST POINT	UPPER ↑
C05		LOWER ↑
C06	CHROMA POINT	UPPER ↑
C07		LOWER ↑
C08	PHASE POINT	UPPER ↑
C09		LOWER ↑
C10	OSD HORIZONTAL POSITION	↑
C11	OSD VERTICAL FREQUENCY (50Hz)	↑
C12	OSD VERTICAL FREQUENCY (60Hz)	↑
C13	BRIGHT (SINGLE HORIZONTAL LINE)	↑
C14	SHARP (CENTER VALUE)	↑
C15	HVT - H.	↑
C16	HVT - V.	↑
C17	HVT - H. (UNDER SCAN)	↑
C18	HVT - V. (UNDER SCAN)	↑
C19	V - SS. CR	↑
C20	TRAPEZ	↑
C21	HOUR METER (100H UNIT)	↑
C22	BLUE CHECK (ON / OFF)	↑

SERVICE ADJUSTMENTS

BEFORE STARTING SERVICE ADJUSTMENT

1. Confirm the proper AC power voltage is being supplied.
2. Supply power to the set and measuring instruments and allow to warm up for at least 30 minutes.
3. The setting is made on basis of the initial setting values. The setting values which adjust the screen to the optimum condition can be different from the initial setting values.
4. Use care not to disturb controls and switches not mentioned in the adjustment items.

ADJUSTMENT SETTINGS

For the functions except for those which must set the values every time during the adjustment procedure, begin to make adjustments after returning the setting values to the initial values while referring to the table in page 7. If each value of the functions has not been initialized, the adjustments cannot be made properly.

ADJUSTMENT ITEMS

- MEASURING INSTRUMENTS FIXTURE AND STANDARD SIGNAL
- ADJUSTMENT LOCATIONS
- REPLACEMENT OF CHIP COMPONENT
- BASIC OPERATION OF SERVICE MENU
- SERVICE MENU COMPOSITION CHART
- INITIAL SETTING OF THE SERVICE MENU ADJUSTMENT ITEMS
- ADJUSTMENT METHOD
- DEFLECTION CIRCUIT ADJUSTMENT
- SELF DIAGNOSIS FUNCTION

MEASURING INSTRUMENTS FIXTURE AND STANDARD SIGNAL

● FIXTURE

- DC voltmeter (digital voltmeter)
 - Oscilloscope
 - Signal generator (PAL/NTSC systems)
 - Colour analyser
 - High voltage meter
- The wave form of signals refer following figure.

FOCUS AND SCREEN ADJUSTMENT HOLES

- The FOCUS and SCREEN adjustment holes are on the rear panel.

[CAUTION]

Be sure to use a non-metallic driver for adjusting there VRs. A metallic driver can cause damage by shorting.

● STANDARD SIGNAL

VIDEO SIGNAL (PAL / NTSC COLOUR BAR)

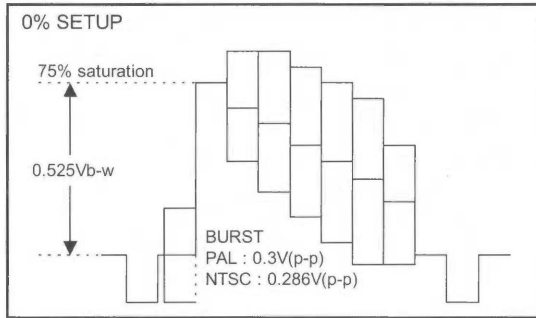

Y / C SEPARATE SIGNAL (COLOUR BAR)

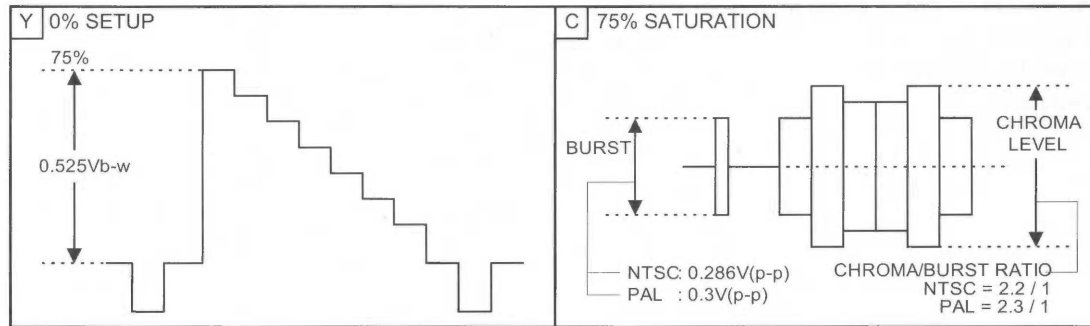

■ ADJUSTMENT LOCATIONS

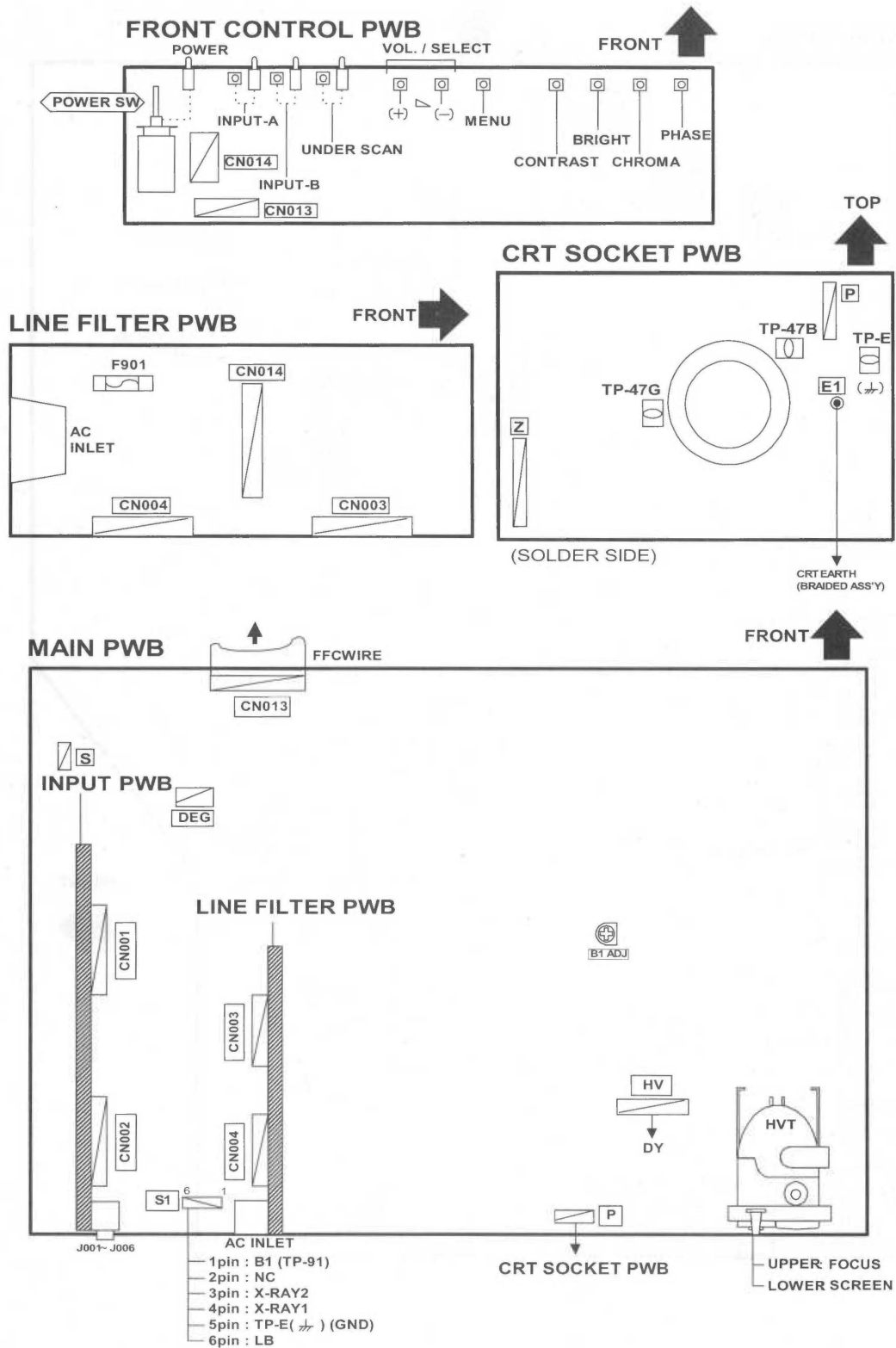

ADJUSTMENT

- 1pin : TP-Y
- 2pin : TP-CR
- 3pin : TP-CB
- 4pin : GND ()
- 5pin : TP-B

INPUT PWB

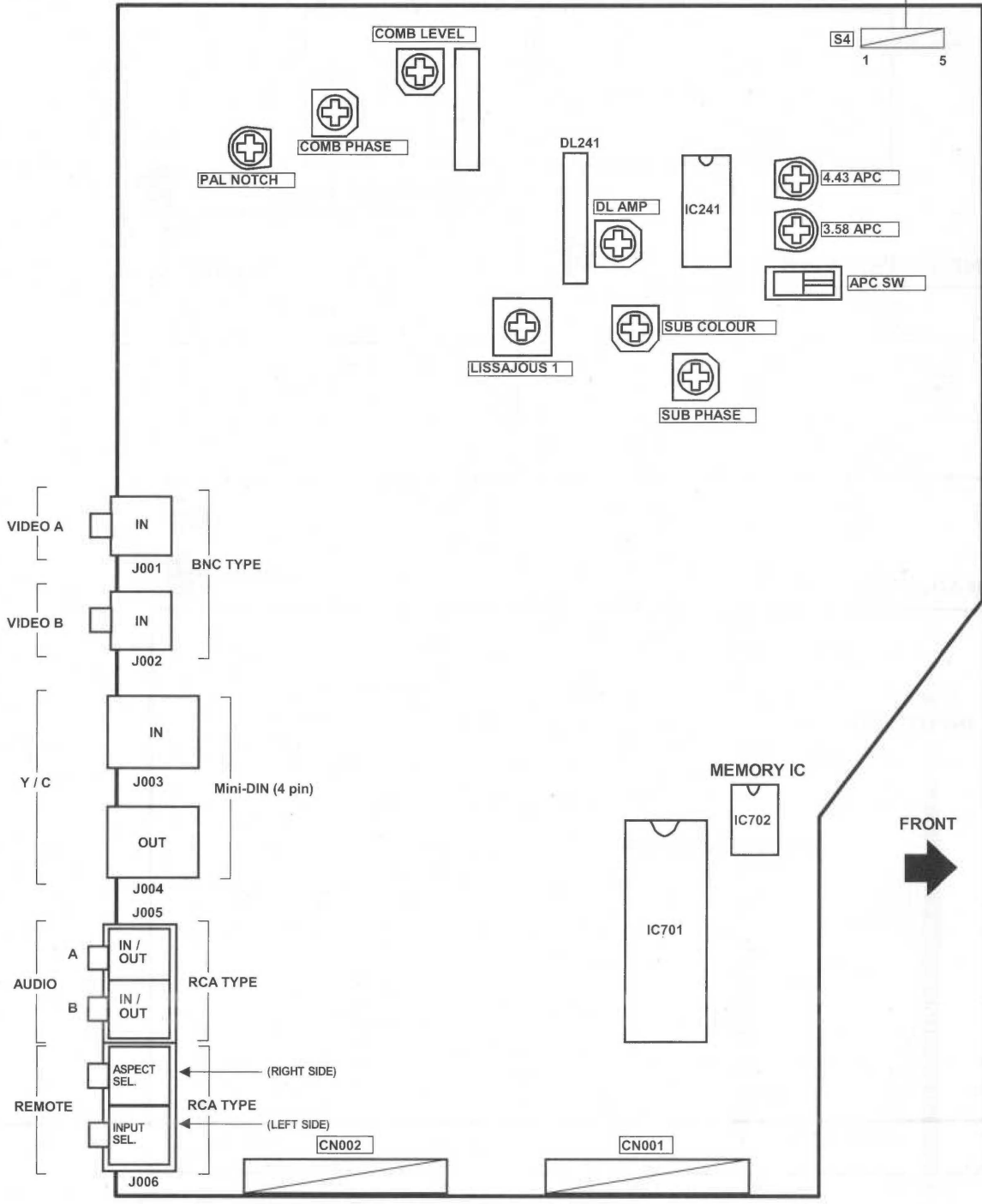
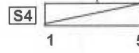

■ REPLACEMENT OF CHIP COMPONENT

■ CAUTIONS

1. Avoid heating for more than 3 seconds.
2. Do not rub the electrodes and the resist parts of the pattern.
3. When removing a chip part, melt the solder adequately.
4. Do not reuse a chip part after removing it.

■ SOLDERING IRON

1. Use a high insulation soldering iron with a thin pointed end of it.
2. A 30w soldering iron is recommended for easily removing parts.

■ REPLACEMENT STEPS

1. How to remove Chip parts

◆ Resistors, capacitors, etc

- (1) As shown in the figure, push the part with tweezers and alternately melt the solder at each end.

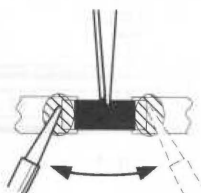

- (2) Shift with tweezers and remove the chip part.



◆ Transistors, diodes, variable resistors, etc

- (1) Apply extra solder to each lead.



- (2) As shown in the figure, push the part with tweezers and alternately melt the solder at each lead. Shift and remove the chip part.

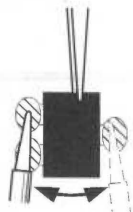

Note : After removing the part, remove remaining solder from the pattern.

2. How to install Chip parts

◆ Resistors, capacitors, etc

- (1) Apply solder to the pattern as indicated in the figure.

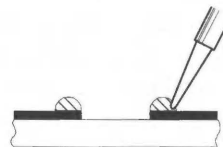

- (2) Grasp the chip part with tweezers and place it on the solder. Then heat and melt the solder at both ends of the chip part.

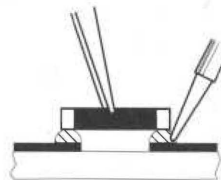

◆ Transistors, diodes, variable resistors, etc

- (1) Apply solder to the pattern as indicated in the figure.
- (2) Grasp the chip part with tweezers and place it on the solder.
- (3) First solder lead **A** as indicated in the figure.

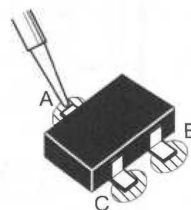

- (4) Then solder leads **B** and **C**.

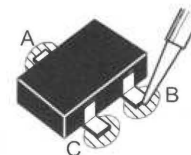

■ BASIC OPERATION OF SERVICE MENU

1. SERVICE MENU ITEMS

With the SERVICE MENU, various settings can be made, and they are broadly classified in the following items of adjustments.

- SIGNAL BLOCK** This mode adjusts the data of the various signal voltage controls.
- WHITE BALANCE BLOCK** ... This mode adjusts the data of the WHITE BALANCE adjustment.
- DEFLECTION BLOCK** This mode adjusts the data of the DEFLECTION circuit.
- CONTROL BLOCK** This mode adjusts the whole of the systems
(This is a fixed value, Don't adjust it.)

2. BASIC OPERATION OF THE SERVICE MENU

(1) HOW TO ENTER THE SERVICE MENU

- ① Press **MENU** key and **CONTRAST** key simultaneously. (Fig. 1)
- ② The letter "S" appears at the upper left of the screen.(Fig. 2)
- ③ Press **MENU** key and **PHASE** key simultaneously.
- ④ The screen display "PLEASE DON'T TOUCH".(Fig. 3)
- ⑤ Press **+ key** or **- key** to display the SERVICE MENU as shown in Fig. 4.
If step ④ state continues for more than 5 seconds without a further operation, the display extinguishes and the mode is released.

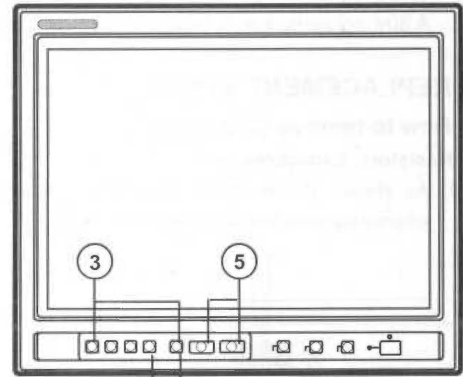

Fig. 1

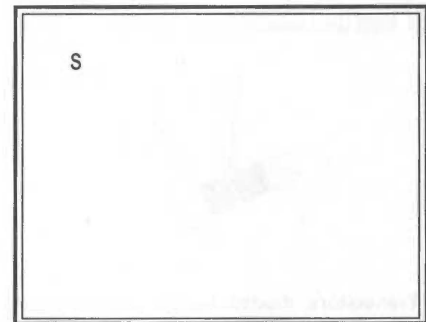

Fig. 2

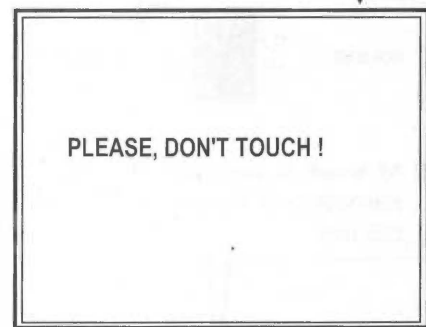

Fig. 3

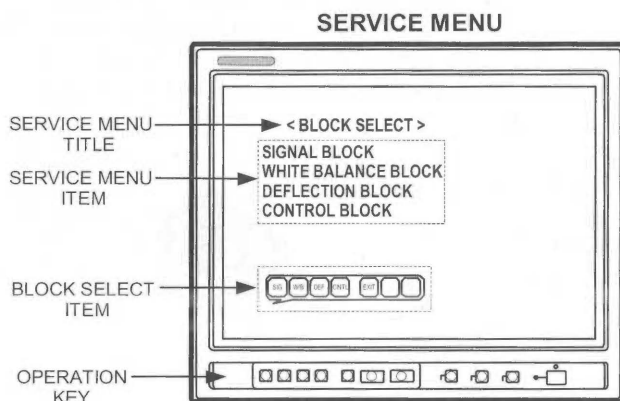
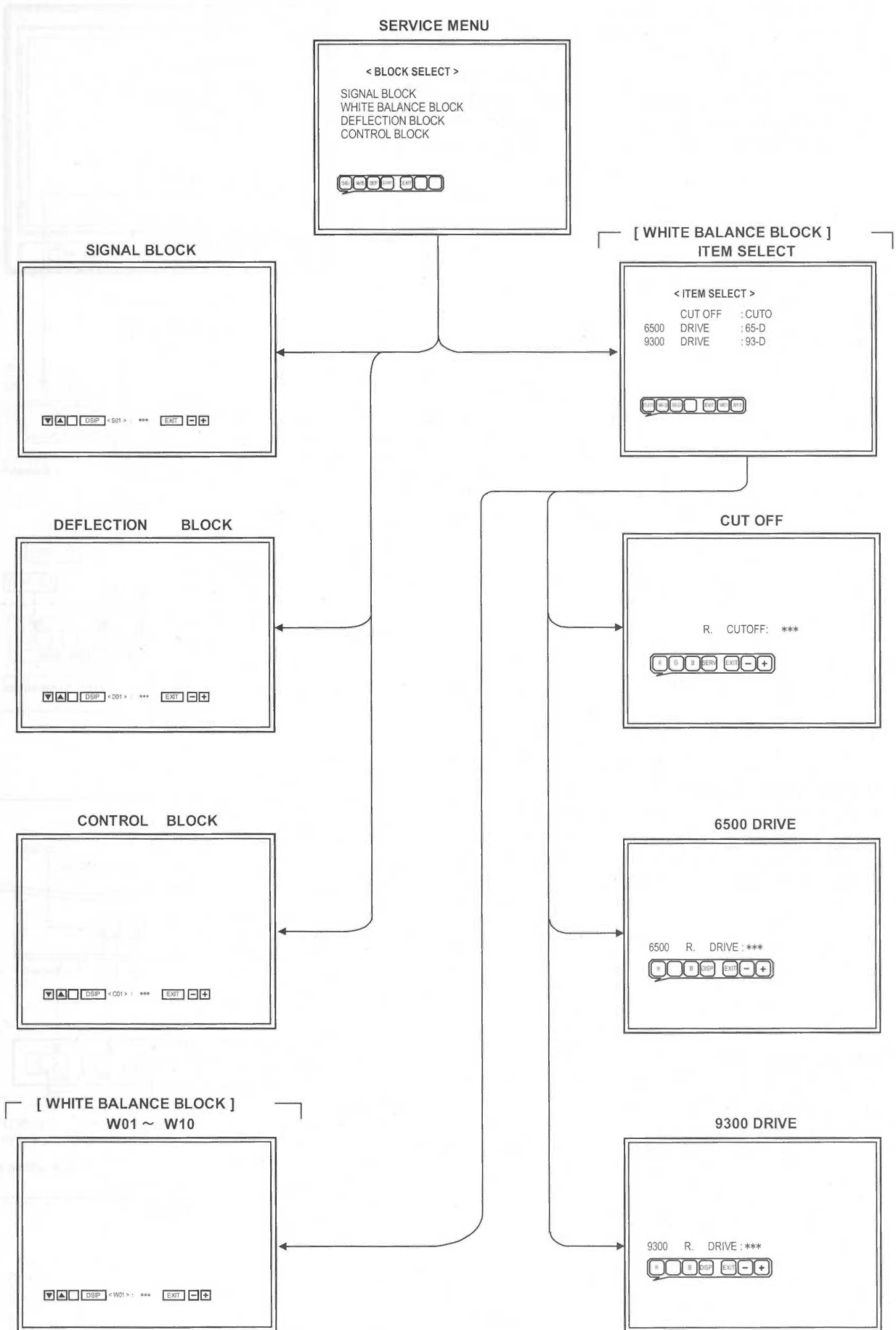

Fig. 4

SERVICE MENU COMPOSITION CHART



(2) SELECT OF SUB MENU SCREEN (Fig. 5)

- While the SERVICE MENU is displayed.
In accordance with the key control display at the lower side of the screen, operate the various items.

SIGNAL BLOCK(SIG) Press the **PHASE** key
WHITE BALANCE BLOCK(W/B)... press the **CHROMA** key
DEFLECTION BLOCK(DEF)..... Press the **BRIGHT** key
CONTROL BLOCK(CNTL)..... Press the **CONTRAST** key

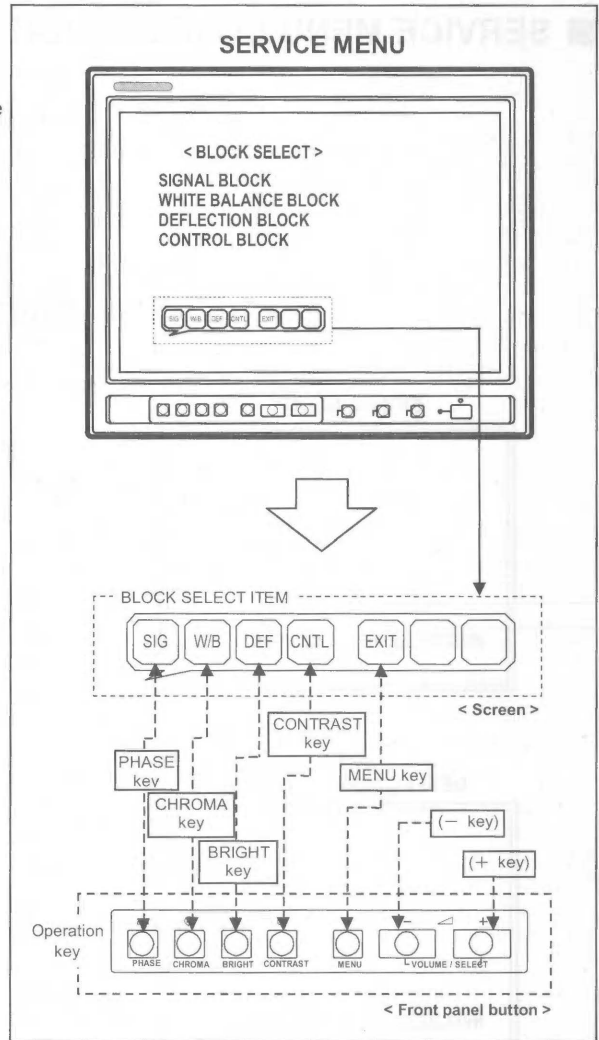

Fig. 5

(3) SETTING VALUE CHANGES

- While the adjustment mode menu is displayed. (Fig. 6)
- ① Press the + key to change the setting value in the + direction.
- ② Press the - key to change the setting value in the - direction.
- ③ Press the **PHASE** key or **CHROMA** key to select the service number.

(4) SERVICE MENU EXIT

- ① When settings are completed, press **MENU** key.
- ② The SERVICE MENU returns.
- ③ Again press **MENU** key.
The screen display extinguishes the SERVICE MENU is exited.

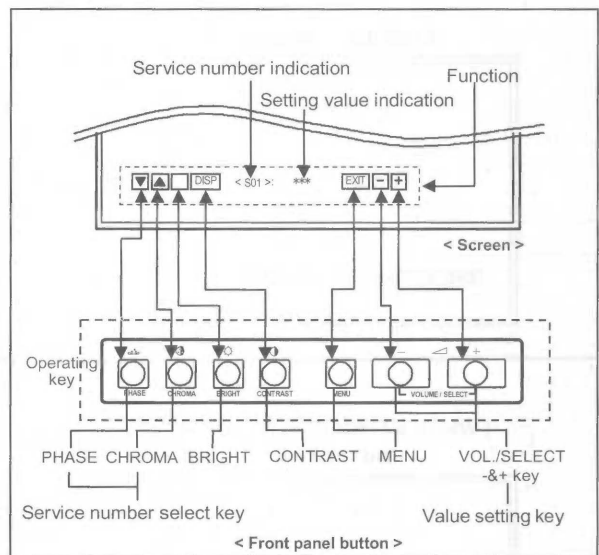

Fig. 6

3. HOW TO OPERATE SERVICE MENU ITEMS

■ SIGNAL BLOCK

- ① Press the **PHASE** key from the <BLOCK SELECT> screen.
- ② Then displays the SIGNAL BLOCK adjustment screen (Fig. 7).
- ③ The select items is shown by the SERVICE Number at the lower of the screen.
- ④ Key control operation are displays as same as the screen lower. The key operations of this mode are following as shown below.
CONTRAST key is the switch of the screen display. If necessary, you can shut off the display. Carefully, values of SERVICE MENU adjustment items are changed while shut off the screen display.
- ⑤ Press the MENU key, then exit from the SIGNAL BLOCK screen to return to the <BLOCK SELECT> screen.

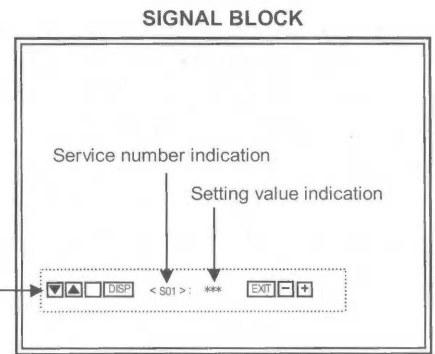
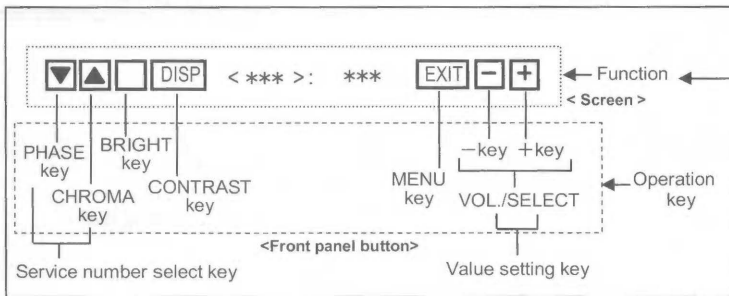

Fig. 7



■ WHITE BALANCE BLOCK

- ① Press the **CHROMA** key from the <BLOCK SELECT> screen (SERVICE MENU) (Fig. 8).
- ② Then screen displays the WHITE BALANCE BLOCK adjustment screen. (Fig. 9)
- ③ The select item is shown by the SERVICE Number at the lower of the screen.
- ④ Press the **MENU** key few times, then exit from the WHITE BALANCE BLOCK screen to return to the <BLOCK SELECT> screen.

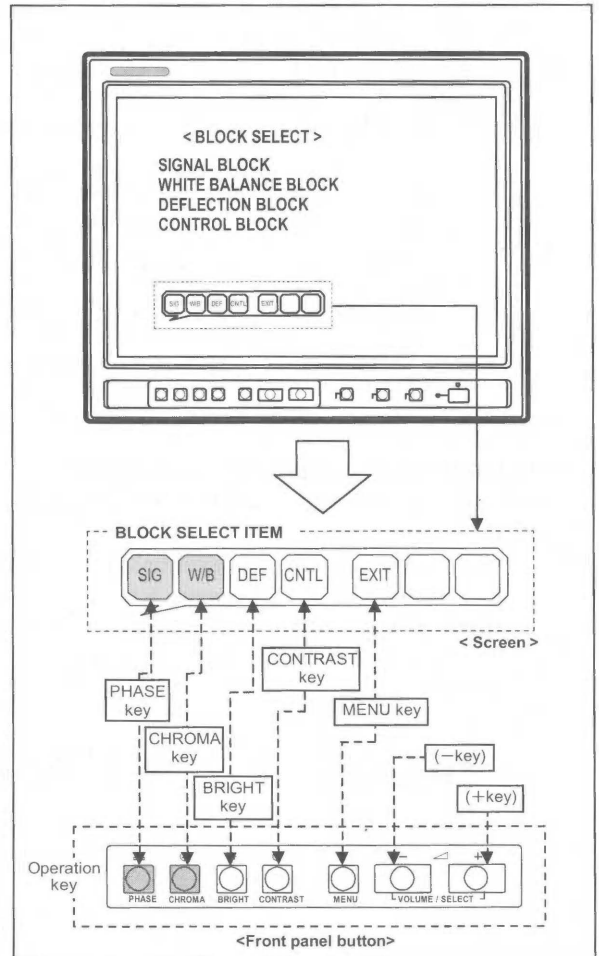

Fig. 8

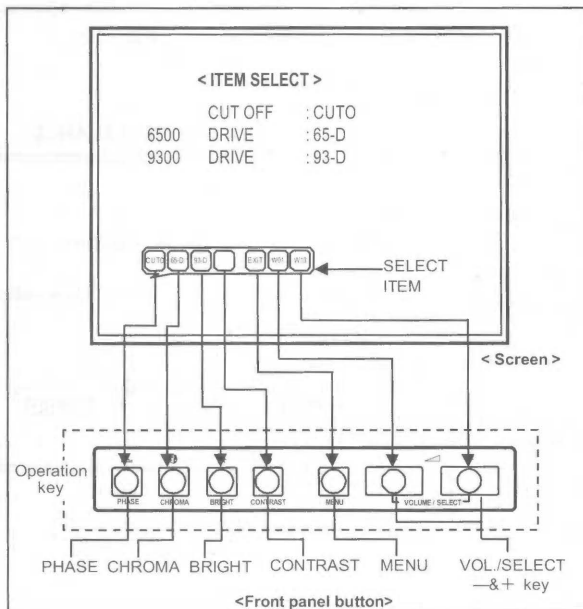

Fig. 9

[WHITE BALANCE Adjustment : METHOD 1]

Accordance with the screen, select the WHITE BALANCE mode that following below.

● CUTOFF adjustment mode (LOW LIGHT)

Press the PHASE key, then enter the CUTOFF adjustment mode as shown in Fig. 10 (LOW LIGHT adjustment mode). In this case, key control is changed as shown below.

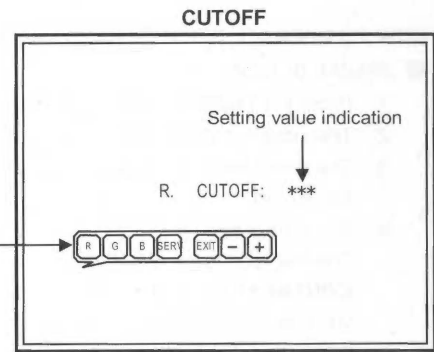
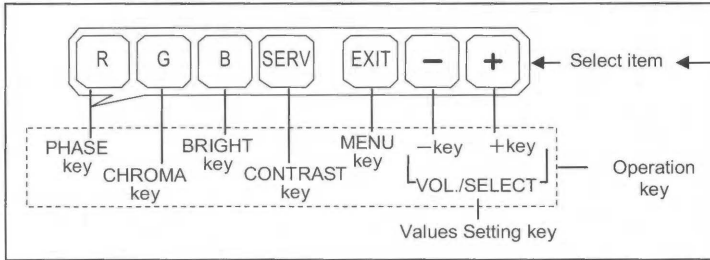

Fig. 10

Press key of the SERV displaying. Shown single horizontal line on or off. (Fig. 11)

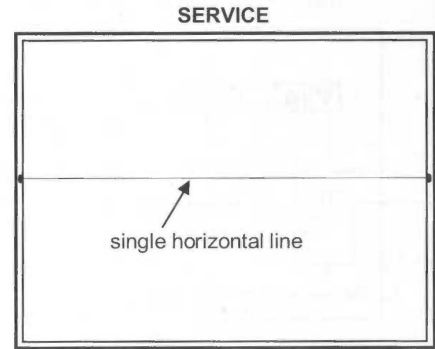

Fig. 11

● 6500 / 9300 drive adjustment mode (HIGH LIGHT)

Press the CHROMA or BRIGHT key, then enter the 6500 drive (or 9300 drive) adjustment mode as shown in Fig. 12 (HIGH LIGHT adjustment mode). In this case, key control is changed as shown below.

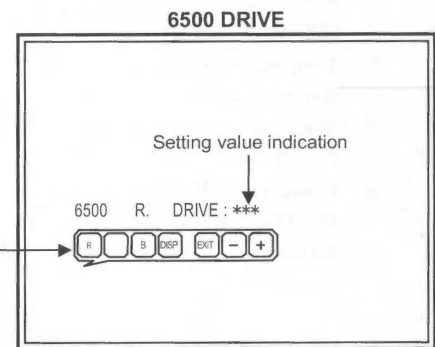
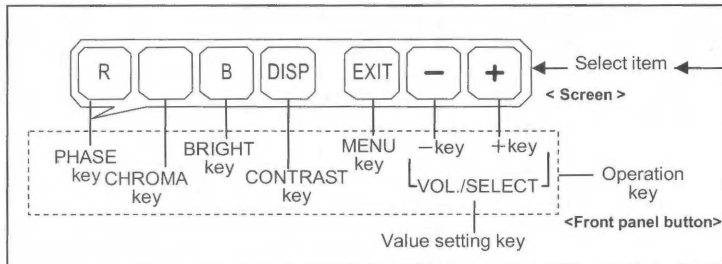
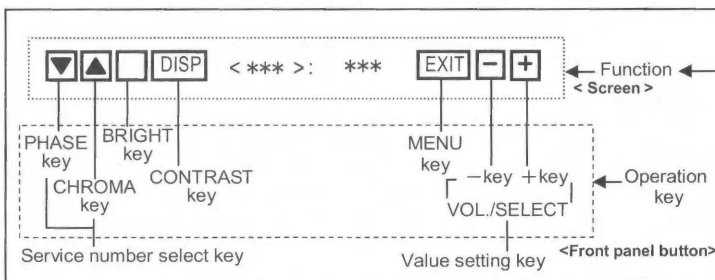

Fig. 12

[WHITE BALANCE Adjustment : METHOD 2]

Accordance with the screen, select the WHITE BALANCE mode that following below.

Press the + key or - key, then enter the WHITE BALANCE full adjustment mode as shown in Fig.13 (this mode both LOW LIGHT and HIGH LIGHT are able to adjust). In the case, key control is changed as shown below. The operation of the mode is as same as SIGNAL BLOCK adjustment operation.



WHITE BALANCE

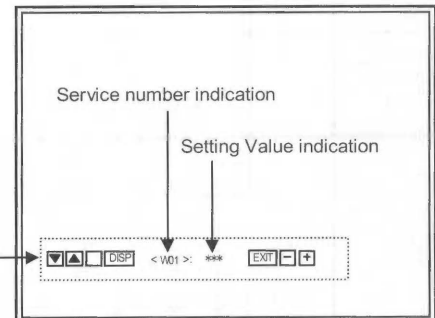
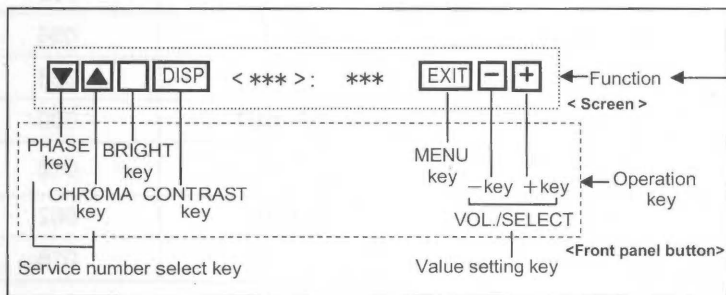

Fig. 13

DEFLECTION BLOCK

- ① Press the **BRIGHT** key from the <BLOCK SELECT> screen.
- ② Then screen displays the DEFLECTION BLOCK adjustment screen (Fig. 14).
- ③ The select item is shown by the SERVICE Number at the lower of the screen (Table 1).
- ④ The adjustment screen changes by case of the signal that use for adjustment (Vertical frequency and screen aspect value).



Key control operation are displays as same as the screen lower. The key operations of this mode are following as shown below. CONTRAST key is the switch of the screen display. If necessary, you can shut off the display. Carefully, values of SERVICE MENU adjustment items are changed while shut off the screen daily.

DEF. BLOCK

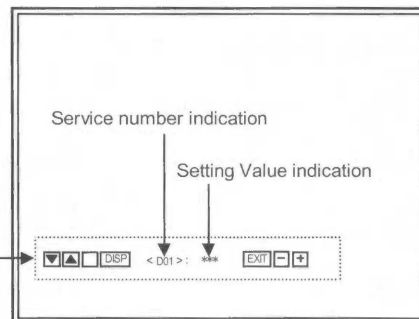

Fig. 14

SIGNAL	SCREEN DISPLAY
50Hz 4:3	<D0 * >
60Hz 4:3	<DA * >
50Hz 16:9	<DB * >
60Hz 16:9	<DC * >
50Hz UNDER SCAN,4:3	<DD * >
60Hz UNDER SCAN,4:3	<DE * >
50Hz UNDER SCAN, 16:9	<DF7,DF8>
60Hz UNDER SCAN, 16:9	<DG7,DG8>

Table 1

CONTROL BLOCK (This is a fixed type Don't adjust it).

- ① Press the **CONTRAST** key from the <BLOCK SELECT> screen.
- ② Then screen displays the CONTROL BLOCK adjustment screen (Fig. 15).
- ③ The select item is shown by the SERVICE Number at the lower of the screen.
- ④ Key control operation are displays as same as the screen lower. The key operations of this mode are following as shown below.

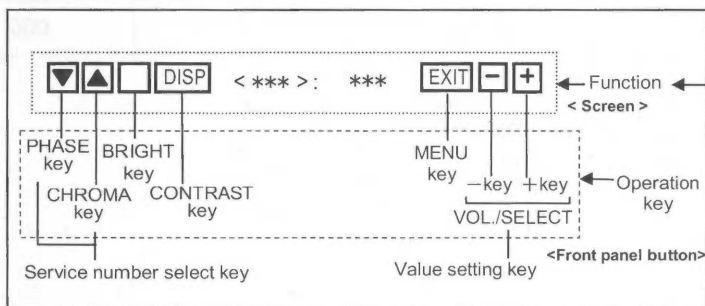

CONTROL BLOCK

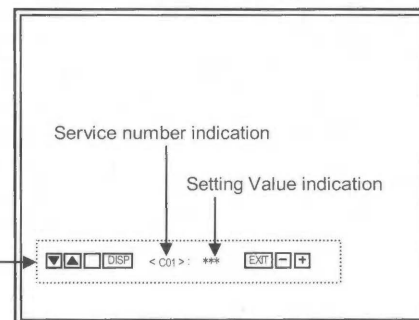

Fig. 15

■ INITIAL SETTINGS OF THE SERVICE MENU ADJUSTMENT ITEMS

1. SIGNAL BLOCK

SERVICE Number	INPUT SIGNAL	CONTENTS	VARIABLE RANGE	TYPE	INITIAL VALUE
S01	VIDEO	BRIGHT	000 ~ 255	ABSOLUTE	132
S02		CONTRAST	000 ~ 127	↑	063
S03		CHROMA (PAL)	000 ~ 127	↑	060
S04		CHROMA (NTSC)	000 ~ 127	↑	056
S05		PHASE (NTSC)	000 ~ 127	↑	068
S06	————	BRIGHT (under scan)	-128 ~ 000 ~ +127	OFFSET	000
S07	————	CONTRAST (under scan)	-128 ~ 000 ~ +127	↑	-012
S08	VIDEO	PHASE (PAL)	000 ~ 127	FIXED	062
S09		CONT. TRACKING	000 ~ 031	↑	016

2. WHITE BALANCE BLOCK

SERVICE Number	INPUT SIGNAL	CONTENTS	VARIABLE RANGE	TYPE	INITIAL VALUE
W01	VIDEO	R. CUTOFF	000 ~ 255	ABSOLUTE	050
W02		G. CUTOFF	000 ~ 255	↑	050
W03		B. CUTOFF	000 ~ 255	↑	050
W04		R. DRIVE (6500)	000 ~ 127	↑	087
W05		B. DRIVE (6500)	000 ~ 127	↑	046
W06		R. DRIVE (9300)	000 ~ 127	↑	079
W07		B. DRIVE (9300)	000 ~ 127	↑	059
W08	————	R. CUTOFF (Under scan)	-128 ~ 000 ~ +127	OFFSET	000
W09		G. CUTOFF (Under scan)	-128 ~ 000 ~ +127	↑	000
W10		B. CUTOFF (Under scan)	-128 ~ 000 ~ +127	↑	000

3. DEFLECTION BLOCK

SERVICE Number	SCAN SIZE ASPECT RATIO	VERTICAL FREQUENCY	CONTENTS	VARIABLE RANGE	TYPE	INITIAL VALUE
D01	NORMAL (4:3)	50Hz	HORIZONTAL POSITION	000 ~ 031	ABSOLUTE	014
D02			HORIZONTAL SIZE	000 ~ 063	↑	035
D03			VERTICAL POSITION	000 ~ 127	↑	065
D04			VERTICAL SIZE	000 ~ 127	↑	055
D05			VERTICAL LINEARITY	000 ~ 031	↑	024
D06			VERTICAL S-CORRECTION	000 ~ 063	↑	035
D07			E-W PARABOLA	000 ~ 063	↑	019
D08			E-W CORNER	000 ~ 031	↑	021
DA1	NORMAL (4:3)	60Hz	HORIZONTAL POSITION	-032 ~ 000 ~ +031	OFFSET	+002
DA2			HORIZONTAL SIZE	-064 ~ 000 ~ +063	↑	-004
DA3			VERTICAL POSITION	-128 ~ 000 ~ +127	↑	+001
DA4			VERTICAL SIZE	-128 ~ 000 ~ +127	↑	-001
DA5			VERTICAL LINEARITY	-032 ~ 000 ~ +031	↑	000
DA6			VERTICAL S-CORRECTION	-064 ~ 000 ~ +063	↑	000
DA7			E-W PARABOLA	-064 ~ 000 ~ +063	↑	000
DA8			E-W CORNER	-032 ~ 000 ~ +031	↑	000
DB1	16:9	50Hz	HORIZONTAL POSITION	-032 ~ 000 ~ +031	OFFSET	000
DB2			HORIZONTAL SIZE	-064 ~ 000 ~ +063	↑	000
DB3			VERTICAL POSITION	-128 ~ 000 ~ +127	↑	000
DB4			VERTICAL SIZE	-128 ~ 000 ~ +127	↑	-031
DB5			VERTICAL LINEARITY	-032 ~ 000 ~ +031	↑	000
DB6			VERTICAL S-CORRECTION	-064 ~ 000 ~ +063	↑	000
DB7			E-W PARABOLA	-064 ~ 000 ~ +063	↑	-007
DB8			E-W CORNER	-032 ~ 000 ~ +031	↑	-001
DC1	16:9	60Hz	HORIZONTAL POSITION	-032 ~ 000 ~ +031	OFFSET	000
DC2			HORIZONTAL SIZE	-064 ~ 000 ~ +063	↑	000
DC3			VERTICAL POSITION	-128 ~ 000 ~ +127	↑	000
DC4			VERTICAL SIZE	-128 ~ 000 ~ +127	↑	-029
DC5			VERTICAL LINEARITY	-032 ~ 000 ~ +031	↑	000
DC6			VERTICAL S-CORRECTION	-064 ~ 000 ~ +063	↑	000
DC7			E-W PARABOLA	-064 ~ 000 ~ +063	↑	-007
DC8			E-W CORNER	-032 ~ 000 ~ +031	↑	-003
DD1	UNDER SCAN (4:3)	50Hz	HORIZONTAL POSITION	-032 ~ 000 ~ +031	OFFSET	000
DD2			HORIZONTAL SIZE	-064 ~ 000 ~ +063	↑	-010
DD3			VERTICAL POSITION	-128 ~ 000 ~ +127	↑	000
DD4			VERTICAL SIZE	-128 ~ 000 ~ +127	↑	000
DD5			VERTICAL LINEARITY	-032 ~ 000 ~ +031	↑	000
DD6			VERTICAL S-CORRECTION	-064 ~ 000 ~ +063	↑	000
DD7			E-W PARABOLA	-064 ~ 000 ~ +063	↑	-013
DD8			E-W CORNER	-032 ~ 000 ~ +031	↑	-003
DE1	UNDER SCAN (4:3)	60Hz	HORIZONTAL POSITION	-032 ~ 000 ~ +031	OFFSET	000
DE2			HORIZONTAL SIZE	-064 ~ 000 ~ +063	↑	-008
DE3			VERTICAL POSITION	-128 ~ 000 ~ +127	↑	000
DE4			VERTICAL SIZE	-128 ~ 000 ~ +127	↑	000
DE5			VERTICAL LINEARITY	-032 ~ 000 ~ +031	↑	000
DE6			VERTICAL S-CORRECTION	-064 ~ 000 ~ +063	↑	000
DE7			E-W PARABOLA	-064 ~ 000 ~ +063	↑	-013
DE8			E-W CORNER	-032 ~ 000 ~ +031	↑	-003

SERVICE Number	SCAN SIZE ASPECT RATIO	VERTICAL FREQUENCY	CONTENTS	VARIABLE RANGE	TYPE	INITIAL VALUE
DF7	UNDER SCAN (16:9)	50Hz	E-W PARABORA	-064 ~ 000 ~ +063	OFFSET	+005
DF8			E-W CORNER	-032 ~ 000 ~ +031	↑	+003
DG7	UNDER SCAN (16:9)	60Hz	E-W PARABORA	-064 ~ 000 ~ +063	OFFSET	+004
DG8			E-W CORNER	-032 ~ 000 ~ +031	↑	000

4. CONTROL BLOCK (This is a fixed type Don't adjust it.)

SERVICE Number	ITEM	VARIABLE RANGE	TYPE	INITIAL VALUE
C01	• DESTINATION 000 : JAPAN / 001 : EUROPE 002 ~ 011 : undefine	000 ~ 011	FIXED	001
C02	BRIGHT POINT	UPPER	↑	016
C03		LOWER	↑	026
C04	CONTRAST POINT	UPPER	↑	016
C05		LOWER	↑	026
C06	CHROMA POINT	UPPER	↑	040
C07		LOWER	↑	040
C08	PHASE POINT	UPPER	↑	040
C09		LOWER	↑	040
C10	OSD HORIZONTAL POSITION	000 ~ 010	↑	007
C11	OSD VERTICAL FREQUENCY (50Hz)	000 ~ 010	↑	004
C12	OSD VERTICAL FREQUENCY (60Hz)	000 ~ 010	↑	002
C13	BRIGHT (SINGLE HORIZONTAL LINE)	000 ~ 127	↑	000
C14	SHARPNESS (CENTER VALUE)	000 ~ 127	↑	020
C15	HVT-H	000 ~ 007	↑	001
C16	HVT-V	000 ~ 007	↑	002
C17	HVT-H (UNDER SCAN)	000 ~ 007	↑	000
C18	HVT-V (UNDER SCAN)	000 ~ 007	↑	001
C19	V-SS. CR	000 ~ 015	↑	000
C20	TRAPEZ.	000 ~ 127	↑	063
C21	HOURLY TIMER (100H unit)	000 ~ 650	RUNNING VALUE	000
C22	BLUE CHECK (ON / OFF)	000 ~ 001	FIXED	000

■ ADJUSTMENT METHOD

Item	Test equipment	Test points	Adjustment locations	Adjustment procedure
B1 power supply adjustment	Voltmeter Variable transformer	R958 [TP-91(B1): (S1 ① pin)] HEAT SINK(H002) [TP-E(GND): (S1 ⑤ pin)] [MAIN PWB] SCREEN VR [Lower knob : In FBT]	B1 adjust VR [MAIN PWB]	<ol style="list-style-type: none"> 1. Set power supply voltage to AC230V ± 5V. 2. Select WHITE BALANCE BLOCK mode. 3. Select CUTOFF adjustment mode (LOW LIGHT mode). 4. Press "SERV" switch as CONTRAST key, to display the horizontal line. 5. Adjust the SCREEN VR to disappear the horizontal line. 6. Adjust "B1 adjust VR" to set the B1 voltage to 53V ± 0.2V. 7. Readjust the SCREEN VR to appear the horizontal line faintly, and cancel the horizontal line to press the "SERV" switch. <p>CAUTION : HEAT SINK (H003) is energised, and not GND.</p>
High voltage check	High voltage meter	CRT Anode SCREEN VR [Lower knob : In FBT]		<ul style="list-style-type: none"> • B1 voltage adjustment have been finished. <ol style="list-style-type: none"> 1. Set power supply voltage to AC230V ± 5V. 2. Select WHITE BALANCE BLOCK mode. 3. Select CUTOFF adjustment mode (LOW LIGHT mode). 4. Press "SERV" switch as CONTRAST key, to display the horizontal line. 5. Adjust the SCREEN VR to disappear the horizontal line. 6. Connect the high voltage meter to the CRT anode and check for 23.7 ~ 26.3kV. 7. Readjust the SCREEN VR to appear the horizontal line faintly, and cancel the horizontal line to press the "SERV" switch. <p>CAUTION : HEAT SINK (H003) is energised, and not GND.</p>
Focus adjustment	Signal generator (Resolution pattern)	FOCUS VR [Upper knob : In FBT]		<ol style="list-style-type: none"> 1. Adjust the Focus VR for optimum focus where moire is not apparent. 2. Darken the picture and adjust the focus by tuning counter-clockwise from the position where focus is poor. 3. Alternately repeat the above steps to obtain the optimum position. <ul style="list-style-type: none"> • Focus can be adjusted easily by displaying the menu.

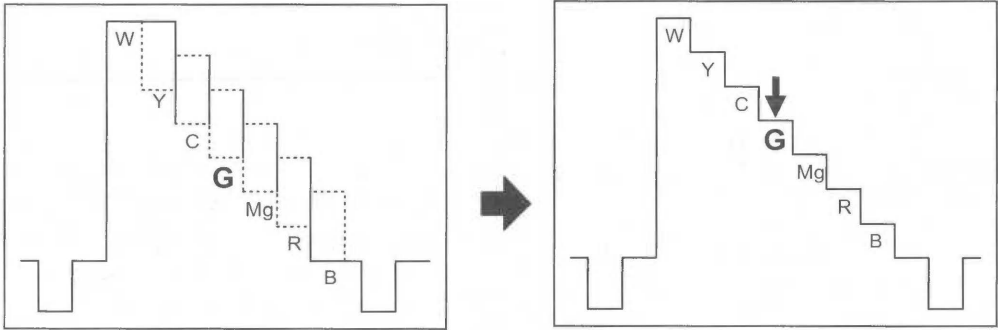
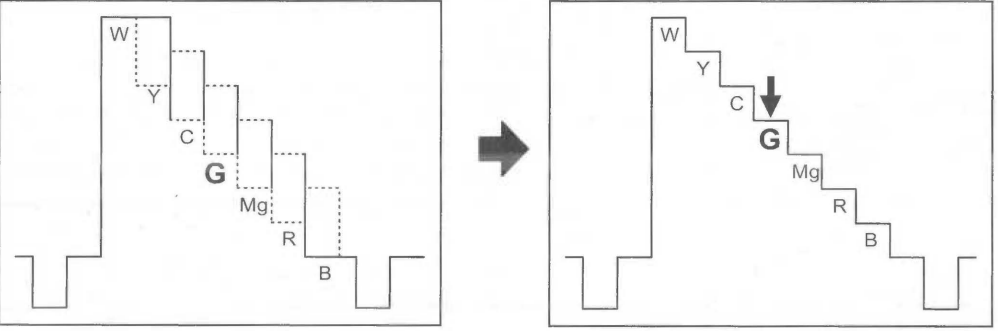
Item	Test equipment	Test points	Adjustment locations	Adjustment procedure
<p>NTSC Comb filter adjustment</p>	<p>Signal generator (NTSC colour bar) Oscillo-scope</p>	<p>TP-Y : S4 ①pin [INPUT PWB]</p>	<p>COMB PHASE VR COMB LEVEL VR [INPUT PWB]</p>	<ol style="list-style-type: none"> 1. Input the NTSC colour bar signal. 2. Connect the oscillo-scope probe to the TP-Y. 3. Adjust the COMB PHASE VR to minimize the chroma component of the green part in the colour bar signal. 4. Adjust the COMB LEVEL VR to minimize the chroma component of the GREEN part in the colour bar signal. 5. Alternately adjust the COMB PHASE and COMB LEVEL to adjust them correct.
				
<p>PAL TRAP Filter adjustment</p>	<p>Signal generator (PAL colour bar) Oscillo-scope</p>	<p>TP-Y : S4 ①pin [INPUT PWB]</p>	<p>PAL NOTCH TRIM. [INPUT PWB]</p>	<ol style="list-style-type: none"> 1. Input the PAL colour bar signal. 2. Connect the oscillo-scope probe to the TP-Y. 3. Adjust the PAL NOTCH Trimer to minimize the chroma component of the GREEN part in the colour bar signal.
				

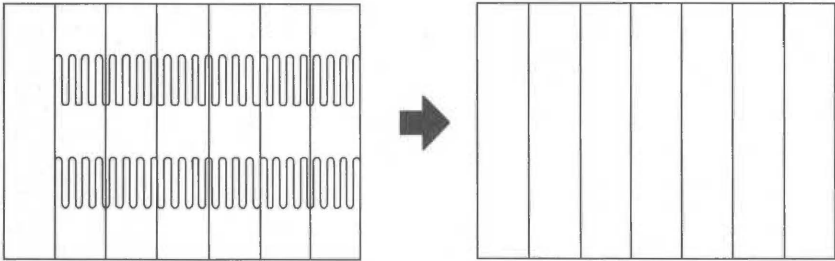
Item	Test equipment	Test points	Adjustment locations	Adjustment procedure
<p>PAL APC Adjustment</p>	<p>Signal generator (PAL colour bar) Oscillo-scope</p>	<p>TP-CR : S4② pin TP-CB : S4③ pin [INPUT PWB]</p>	<p>APC SW SUB COLOUR VR LISSAJOUS 1 TR. DL AMP VR [INPUT PWB]</p>	<ul style="list-style-type: none"> ● Low light white balance adjustment have been correct finished. <ol style="list-style-type: none"> 1. Input the PAL colour bar signal. 2. Connect the oscillo-scope probe to the TP-CR and TP-CB, and switch the sweep mode of the osciro-scope to the X-Y display. 3. Turn the APC SW to "Adjust" side from "Normal" side to cancel the colour synchronous mode. 4. Adjust the SUB COLOUR VR to the wave form of the lissajous not to close by each other. 5. Then alternately adjust the LISSAJOUS 1 TRANSF and DL AMP VR, so that to be 3 straight lines from 6 ovals. 6. Release the APC SW to the "Normal" side.
				
<p>PAL chroma Synchronous adjustment</p>	<p>Signal generator (PAL full colour bar)</p>	<p>SCREEN</p>	<p>APC SW 4.43 APC TRIM. [INPUT PWB]</p>	<ul style="list-style-type: none"> ● PAL colour lissajous adjustment have been finished. <ol style="list-style-type: none"> 1. Input the PAL full colour bar. 2. Turn the APC SW to "Adjust" side from "Normal" side to cancel the colour synchronous mode. 3. Adjust the 4.43 APC TRIMER to disappear the colour stripe on the screen. 4. Turn the APC SW to "Normal" side.
				

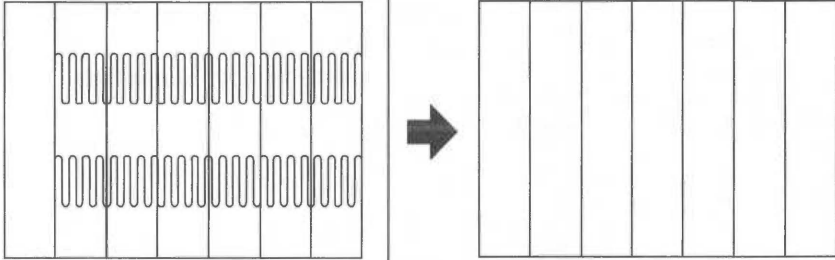
Item	Test equipment	Test points	Adjustment locations	Adjustment procedure
<p>NTSC chroma synchronous adjustment</p>	<p>Signal generator (NTSC full colour bar, NTSC sprit colour bar) Oscillo-scope</p>	<p>SCREEN</p>	<p>APC SW 3.58 APC TRIM. [INPUT PWB]</p>	<ul style="list-style-type: none"> ● PAL colour synchronisation adjustment have been finished. <ol style="list-style-type: none"> 1. Input the NTSC full colour bar. 2. Turn the APC SW to "Adjust" side from "Normal" side to cancel the colour synchronous mode. 3. Adjust the 3.58 APC TRIMER to disappear the colour stripe on the screen. 4. Turn the APC SW to "Normal" side.
				

The three adjustments NTSC SUB CHROMA, NTSC SUB PHASE and PAL SUB CHROMA described in this page are basic adjustments for another three adjustments NTSC 3.58 CHROMA, NTSC 3.58 PHASE, PAL CHROMA and PAL PHASE described in a subsequent page. The adjustments shall be done by using component parts such as semi-fixed type VR. Both adjustments in this page and the subsequent page should be always done at the same time and in accordance with the specified order. Note that unilateral adjustments should be avoided.

Item	Test equipment	Test points	Adjustment locations	Adjustment procedure
<p>NTSC SUB CHROMA Adjustment</p>	<p>Signal generator (NTSC full colour bar) Oscillo-scope</p>	<p>TP-B : S4 ⑤ pin [INPUT PWB]</p>	<p>SUB COLOUR VR</p>	<ul style="list-style-type: none"> • Colour synchronisation adjustment (NTSC & PAL) have been finished. • PAL lissajous adjustment have been finished. <ol style="list-style-type: none"> 1. Input the NTSC full colour bar. 2. Connect the oscillo-scope to TP-B. 3. Adjust the SUB COLOUR VR to bring the voltage of (A) in the illustration to $0 \pm 40\text{mV}$.
<p>NTSC SUB PHASE Adjustment</p>	<p>Signal generator (NTSC full colour bar) Oscillo-scope</p>	<p>TP-B : S4 ⑤ pin [INPUT PWB]</p>	<p>SUB PHASE VR</p>	<ol style="list-style-type: none"> 4. Input the NTSC full colour bar. 5. Connect the oscillo-scope to TP-B. 6. Adjust the SUB PHASE VR to bring the voltage of (B) in the illustration to $0 \pm 40\text{mV}$.
<p>PAL SUB CHROMA Adjustment</p>	<p>Signal generator (PAL full colour bar) Oscillo-scope</p>	<p>TP-CR: S4 ② pin [INPUT PWB]</p>	<p>SUB COLOUR VR</p>	<ol style="list-style-type: none"> 7. Input the PAL full colour bar. 8. Connect the oscillo-scope to TP-CR. 9. Adjust the SUB COLOUR VR to bring the voltage of (C) in the illustration to $500 \pm 20\text{mV}$.

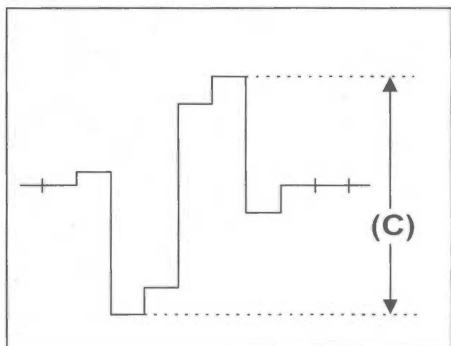
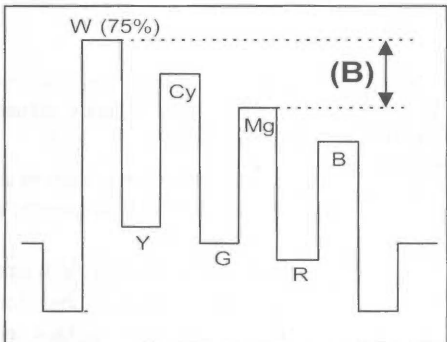
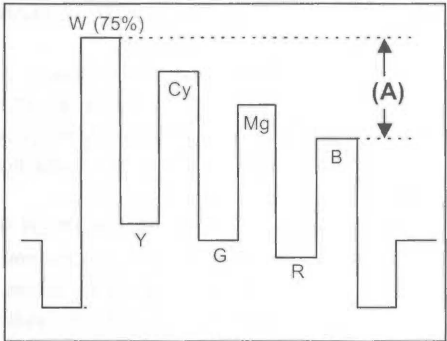

It must be set the composite VIDEO signal input and normal scan mode when adjust the white balance.

Item	Test equipment	Test points	Adjustment locations	Adjustment procedure
WHITE BALANCE (Low light) adjustment	Signal generator (Resolution pattern)	SCREEN VR [Lower knob in FBT]	W01 R CUTOFF W02 G CUTOFF W03 B CUTOFF [SERVICE MENU]	<ul style="list-style-type: none"> ● B1 voltage adjustment have been finished. <ol style="list-style-type: none"> 1. Input the all black signal to VIDEO input (colour off). 2. Confirm the initial setting value of W01, W02, W03 in the SERVICE MENU are 50. 3. Select the WHITE BALANCE block from SERVICE MENU. 4. Select the CUTOFF mode. 5. Press "SERV" switch as CONTRAST key, to display the horizontal line. Carefully adjust the SCREEN VR to horizontal line appears faintly, not to shine much. 6. Gradually turn the SCREEN VR from the left to the right direction to bring one of the red, green and blue colours faintly visible. 7. Then select the CUTOFF switch (R, G or B) that colour except for appears first, and adjusting 2 colours CUTOFF values by pressing the +key, and make horizontal line visible white. 8. Readjust the SCREEN VR to appear the horizontal line faintly, and cancel the horizontal line to press the "SERV" switch.
WHITE BALANCE (High light) 6500K adjustment	Signal generator (Resolution pattern) Colour Analyzer or Colour temperature meter		W04 R DRIVE 6500 W05 B DRIVE 6500 [SERVICE MENU]	<ul style="list-style-type: none"> ● Low light white balance adjustment have been correct finished. <ol style="list-style-type: none"> 1. Input the resolution pattern to VIDEO input. 2. Select the WHITE BALANCE BLOCK from the SERVICE MENU. 3. Select the 65-D mode (High light 6500 mode). 4. Apply the sensor of the Colour temperature meter to the CRT surface, part of the 100% white, adjust the R drive or B drive to setting 6500K (x=0.313, y=0.329). 5. Exit the SERVICE MENU by pressing the MENU key. 6. Check the white balance tracking is optimum when CONTRAST and BRIGHT are up and down.

Item	Test equipment	Test points	Adjustment locations	Adjustment procedure
WHITE BALANCE (High light) 9300K adjustment	Signal generator (Resolution pattern) Colour Analyzer or Colour temperature meter		W06 R DRIVE 9300 W07 B DRIVE 9300 [SERVICE MENU]	<ul style="list-style-type: none"> ● Low light white balance adjustment have been correct finished. <ol style="list-style-type: none"> 1. Input the resolution pattern to VIDEO input. 2. Select the WHITE BALANCE BLOCK from the SERVICE MENU. 3. Select the 93-D mode (High light 9300 mode). 4. Apply the sensor of the Colour temperature meter to the CRT surface, part of the 100% white, adjust the R drive or B drive to setting 9300K (x=0.283, y=0.297). 5. Exit the SERVICE MENU by pressing the MENU key. 6. Check the white balance tracking is optimum when CONTRAST and BRIGHT are up and down.
Bright adjustment	Signal generator (Sprit colour bar)		S01 (BRIGHT) [SERVICE MENU]	<ul style="list-style-type: none"> ● Low light white balance adjustment have been correct finished. <ol style="list-style-type: none"> 1. Input a sprit colour bar signal. 2. Select the SIGNAL BLOCK from the SERVICE MENU. 3. Select the S01 item. 4. Adjust S01 to where the sprit colour bar 0% black component faintly brightens. 5. Check it to on and off the screen display by turning the "DISP" switch.
Contrast adjustment	Signal generator (Colour bar) Oscillo-scope	TP-47G TP-E(↗) [CRT SOCKET PWB]	S02 (CONTRAST) [SERVICE MENU]	<ol style="list-style-type: none"> 1. Input a full colour bar signal. (75 / 0 / 75 / 0) 2. Connect the oscillo-scope probe to TP-47G and TP-E(↗). 3. Select the SIGNAL BLOCK from SERVICE MENU. 4. Select the S02 item. 5. Adjust S02 to set the waveform level to (35 ± 2) Vp-p as shown in figure.

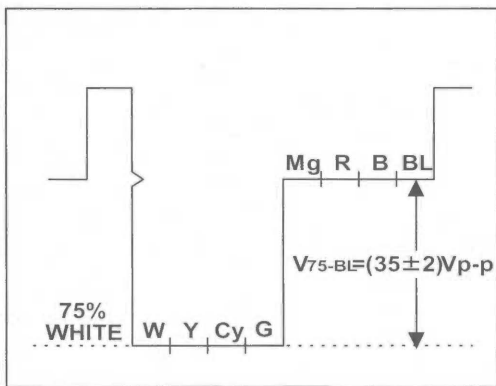

Prior to adjusting PAL CHROMA, PAL PHASE, NTSC 3.58 CHROMA and NTSC 3.58 PHASE, adjustments of PAL system should always be done first.

Item	Test equipment	Test points	Adjustment locations	Adjustment procedure	
<p>PAL CHROMA adjustment</p>	<p>Signal generator (Colour bar)</p> <p>Oscillo-scope</p>	<p>TP-47B TP-E(↗) [CRT SOCKET PWB]</p>	<p>S03 (PAL CHROMA) [SERVICE MENU]</p>	<ol style="list-style-type: none"> 1. Input a PAL colour bar signal. 2. Connect the oscillo-scope probe to TP-47B and TP-E(↗). 3. Select the SIGNAL BLOCK from SERVICE MENU. 4. Select the S03 item. 5. Adjust the S03 to take the level difference in waveform is $0V \pm 2V$ as shown in figure. 	
<p>The diagram shows a PAL color bar waveform. From left to right, the levels are: 75% W (white), Y (yellow), Cy (cyan), G (green), Mg (magenta), R (red), B (blue), and BL (black). A dashed horizontal line is drawn across the B and BL levels. A vertical double-headed arrow to the right of the waveform indicates a level difference of $0V \pm 2V$ between the B and BL levels.</p>	<p>PAL PHASE adjustment</p>			<p>S08 (PAL PHASE) [SERVICE MENU]</p>	<ol style="list-style-type: none"> 1. Check that S08 item data is "062". If the value different, correct it "062".
<p>NTSC 3.58 CHROMA adjustment</p>	<p>Signal generator (Colour bar)</p> <p>Oscillo-scope</p>	<p>TP-47B TP-E(↗) [CRT SOCKET PWB]</p>	<p>S04 (NTSC CHROMA) [SERVICE MENU]</p>	<ol style="list-style-type: none"> 1. Input a NTSC 3.58 colour bar signal. 2. Connect the oscillo-scope probe to TP-47B and TP-E(↗). 3. Select the SIGNAL BLOCK from SERVICE MENU. 4. Select the S04 item. 5. Adjust the S04 to take the level difference in waveform is $0V \pm 2V$ as shown in figure. 	
<p>The diagram shows a NTSC 3.58 color bar waveform. From left to right, the levels are: 75% W (white), Y (yellow), Cy (cyan), G (green), Mg (magenta), R (red), B (blue), and BL (black). A dashed horizontal line is drawn across the B and BL levels. A vertical double-headed arrow to the right of the waveform indicates a level difference of $0V \pm 2V$ between the B and BL levels.</p>					

Item	Test equipment	Test points	Adjustment locations	Adjustment procedure
<p>NTSC 3.58 PHASE adjustment</p>	<p>Signal generator (Colour bar)</p> <p>Oscillo-scope</p>	<p>TP-47B</p> <p>TP-E(↗)</p> <p>[CRT SOCKET PWB]</p>	<p>S05 (NTSC PHASE) [SERVICE MENU]</p>	<ol style="list-style-type: none"> 1. Input a NTSC 3.58 colour bar signal. 2. Connect the oscillo-scope probe to TP-47B and TP-E(↗). 3. Select the SIGNAL BLOCK from SERVICE MENU. 4. Select the S05 item. 5. Adjust the S05 to take the level difference in waveform is $0V \pm 2V$ as shown in figure.

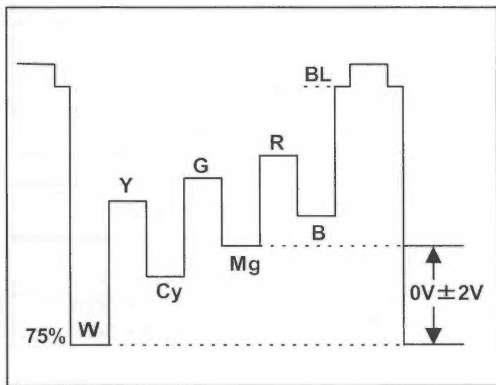

DEFLECTION CIRCUIT ADJUSTMENT

There are 6 modes of DEFLECTION ADJUSTMENT depending upon the kind of input signals.

The adjustments must always be carried out in regular sequence given below.

DATA MODE		SERVICE NUMBER IN SERVICE MENU	SETTING DATA VALUE
4:3	50Hz (PAL)	D0 *	D0 *
	60Hz (NTSC)	DA *	D0 * + DA *
16:9	50Hz (PAL)	DB *	D0 * + DB *
	60Hz (NTSC)	DC *	D0 * + DA * + DC *
UNDER SCAN (4:3)	50Hz (PAL)	DD *	D0 * + DD *
	60Hz (NTSC)	DE *	D0 * + DA * + DE *

● SPECIAL INDICATION

DATA MODE		SERVICE NUMBER IN SERVICE MENU	SETTING DATA VALUE
UNDER SCAN (16:9)	50Hz (PAL)	DF7 DF8	D07 + DB7 + DD7 + DF7 D08 + DB8 + DD8 + DF8
	60Hz (NTSC)	DG7 DG8	D07 + DA7 + DC7 + DE7 + DG7 D08 + DA8 + DC8 + DE8 + DG8

If you change the figures in the course of the adjustments by returning to the preceding steps, all adjustments come to nothing. The screen aspect ratio 4 : 3 at 50Hz (PAL) is regarded as the reference value for all adjustments. The other values obtained in the adjustments using other signals become the off-set values as opposed to the reference values.

Item	Test equipment	Test points	Adjustment locations	Adjustment procedure
H.CENTER H.SIZE adjustment	Signal generator (Cross-hatch pattern)		D01 (H.CENTER) D02 (H.SIZE) [SERVICE MENU]	<ol style="list-style-type: none"> 1. Input a PAL (50Hz) cross hatch pattern signal. 2. Select DEFLECTION BLOCK from SERVICE MENU. 3. Select D01 item. 4. Adjust D01 to align the picture center with the CRT center. 5. Adjust D02 to set horizontal size to 95%. 6. Repeat above step 4 and 5 to adjust correctly. 7. Make sure that there is no distortion with the side pincushion. If necessary, select D07 and D08 and adjust the side pincushion condition. <div style="border: 1px solid black; padding: 5px; margin-top: 10px;"> <p>● Case of 60Hz D01 → DA1 D02 → DA2 D07 → DA7 D08 → DA8</p> </div>
V.CENTER adjustment	Signal generator (Circle pattern)		D03 (V.CENTER) [SERVICE MENU]	<ol style="list-style-type: none"> 8. Input the circle pattern signal. 9. Select D03 item. 10. Adjust D03 to agree with CRT center and signal center of vertical direction. <div style="border: 1px solid black; padding: 5px; margin-top: 10px;"> <p>● Case of 60Hz D03 → DA3</p> </div>

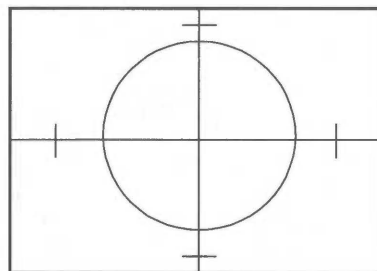
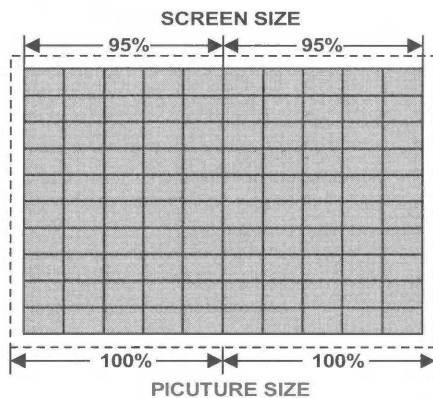

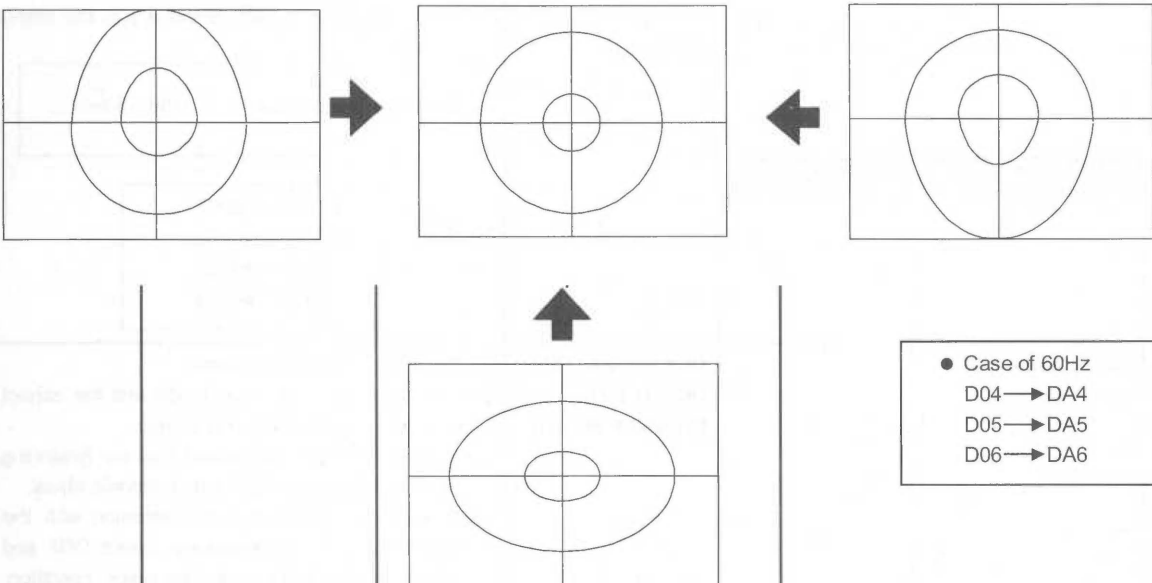
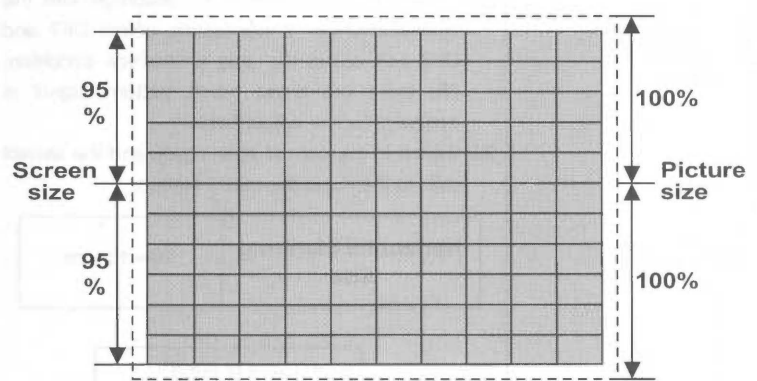
Item	Test equipment	Test points	Adjustment locations	Adjustment procedure
<p>V.LINEARITY Adjustment</p>	<p>Signal generator (Circle pattern)</p>		<p>D04 (V.SIZE) D05 (V.LIN) D06 (V.S.COR) [SERVICE MENU]</p>	<p>11. Input the circle pattern signal. 12. Select D04 item, and adjust it to be able to view the screen top and bottom 100%. 13. Select D05 item. As shown in the figure, adjust it to the vertical scan ratio and vertical linearity becomes regular condition. 14. Select D06 item. Adjust it to the circle pattern becomes correct at the screen edge and center.</p>
<div style="display: flex; justify-content: space-around; align-items: center;">  <div style="border: 1px solid black; padding: 5px; margin-left: auto; margin-right: auto;"> <p>● Case of 60Hz D04 → DA4 D05 → DA5 D06 → DA6</p> </div> </div>				
<p>V.SIZE Adjustment</p>	<p>Signal generator (Cross-hatch pattern)</p>		<p>D04 (V.SIZE) D03 (V.CENTER)</p>	<p>15. Input the cross-hatch pattern signal. 16. Select D04 item, and adjust it to the vertical scan size to 95%. 17. Adjust the D03 item to agree with the signal center of vertical direction and the CRT center.</p>
<div style="display: flex; justify-content: space-around; align-items: center;">  <div style="border: 1px solid black; padding: 5px; margin-left: auto; margin-right: auto;"> <p>● Case of 60Hz D03 → DA3 D04 → DA4</p> </div> </div>				

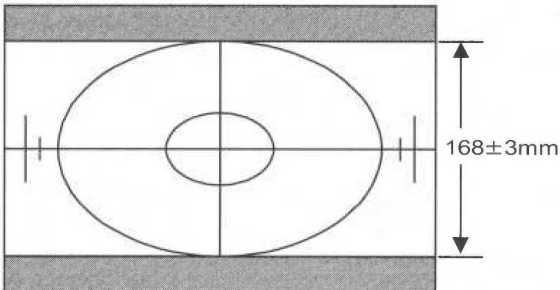
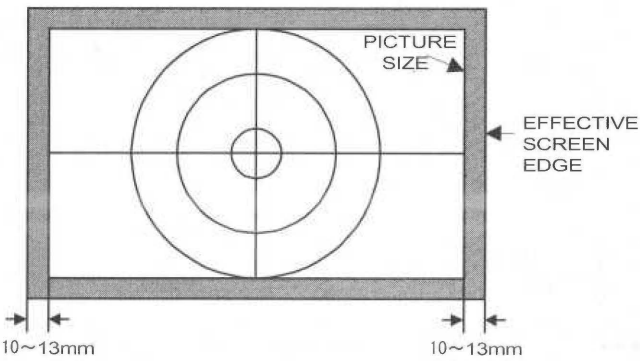
Item	Test equipment	Test points	Adjustment locations	Adjustment procedure		
<p>16:9 V.SIZE Adjustment</p> 	<p>Signal generator (Circle pattern)</p>		<p>DB4 (V.SIZE) [SERVICE MENU]</p>	<p>18. Input the circle pattern signal. 19. Switch the aspect ratio to the 16:9 in the menu screen. 20. Select DB4, and adjust it to the vertical scan size becomes to the value given the table below. 21. Make sure that there is no distortion with the side pincushion. If necessary, select DB7 and DB8 and adjust the side pincushion condition. (To input the cross hatch pattern signal is desirable for the adjustments.) 22. Switch the aspect ratio to the 4:3 in the menu screen.</p> <table border="1" data-bbox="906 621 1368 716"> <tr> <td>Vertical scan size</td> <td>168±3 mm</td> </tr> </table> <div style="border: 1px solid black; padding: 5px; margin-top: 10px;"> <p>● Case of 60Hz DB4→DC4 DB7→DC7 DB8→DC8</p> </div>	Vertical scan size	168±3 mm
Vertical scan size	168±3 mm					
<p>UNDER SCAN H.SIZE, H.CENTER Adjustment</p> 	<p>Signal generator (circle pattern)</p>		<p>DD1 (H.CENTER) DD2 (H.SIZE) [SERVICE MENU]</p>	<p>23. Input the circle pattern signal. 24. Switch to the under scan mode and the aspect ratio to the 4:3 in the menu screen. 25. Select DD1 item, and adjust it to the balancing zone of the left and right area becomes equal. 26. Make sure that there is no distortion with the side pincushion. If necessary, select DD7 and DD8 and adjust the side pincushion condition. (To input the cross hatch pattern signal is desirable for the adjustments.) 27. Select DD2 item, and adjust it to the horizontal blanking frame size becomes to the value given the table below. 28. Switch the aspect ratio to the 16:9 in the menu screen. 29. Make sure that there is no distortion with the side pincushion. If necessary, select DF7 and DF8 and adjust the side pincushion condition. (To input the cross hatch pattern signal is desirable for the adjustments.) 30. Switch to the normal scan mode and the aspect ratio to the 4:3 in the menu screen.</p> <table border="1" data-bbox="906 1591 1368 1686"> <tr> <td>horizontal blanking size</td> <td>10~13 mm</td> </tr> </table> <div style="border: 1px solid black; padding: 5px; margin-top: 10px;"> <p>● Case of 60Hz DD1→DE1 DD2→DE2 DD7→DE7 DD8→DE8 DF7→DG7 DF8→DG8</p> </div>	horizontal blanking size	10~13 mm
horizontal blanking size	10~13 mm					

■ SELF DIAGNOSIS FUNCTION

1. OUTLINE

This model includes a SELF DIAGNOSIS FUNCTION that checks the circuit operating status and in event of malfunction, displays and stores the data in a memory. The data are stored in an I²C memory.

Fault detection starts with the I²C bus and is performed according to the input states of the control lines connected to the MAIN CPU.

2. USAGE

SELF DIAGNOSIS FUNCTION mode entry

- (1) While press the **MENU** key and **CHROMA** key simultaneously, and push the MAIN POWER switch on.
- (2) Then displays the SELF DIAGNOSIS FUNCTION screen. The screen indicates as shown in the table and the SELF DIAGNOSIS FUNCTION mode is entered. If in event a malfunction at RASTER not display, at this time POWER LED flashes.

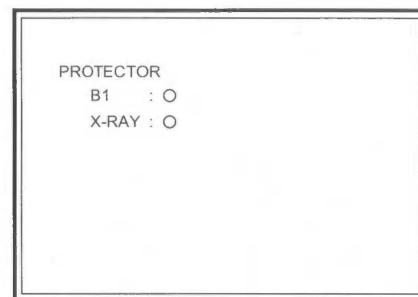

CAUSE	LED FLASHING CYCLE
X-RAY PROTECTOR	Quickly (0.1 sec on / 0.1 sec off cycles)
OVER CURRENT PROTECTOR	Slowly (1.0 sec on / 1.0 sec off cycles)

SELF DIAGNOSIS FUNCTION mode release

Turn the power switch to off or disconnect the power cord from AC outlet. In this way, not to clear the error counts.

Reset the error count

While entered in this mode, press the **MENU** key **BRIGHT** key and simultaneously. Then clear the error count of the each item.

Fault history

The fault history counts up to a maximum of 9 times for each item. If the number of times exceeds 9, the display remains at 9. The fault history remains stored in the memory until deleted.

CONTENTS

CHECK ITEM	DISPLAY	DETECTION CONTENTS
POWER AND DEF CIRCUIT	B1 X-RAY	over current protector operation and over voltage protector operation.

SELF UP CARE FUNCTION

1. OUTLINE

The Self Up Care Function is used to perform maintenance on the printer. It includes functions such as cleaning the print head, replacing the ink, and checking the paper tray.

2. USAGE

1. Press the [Menu] key on the printer's control panel.
2. Use the arrow keys to navigate to the [Self Up Care] option.
3. Press the [Enter] key to select the option.
4. Follow the on-screen prompts to complete the maintenance task.

1.1	SELF UP CARE
1.2	REPLACE INK
1.3	CLEAN PRINT HEAD
1.4	CHECK PAPER TRAY

1.1 SELF UP CARE
The Self Up Care function is used to perform maintenance on the printer. It includes functions such as cleaning the print head, replacing the ink, and checking the paper tray.

CONTENTS

1	SELF UP CARE
2	REPLACE INK
3	CLEAN PRINT HEAD
4	CHECK PAPER TRAY

TM-H140PN STANDARD CIRCUIT DIAGRAM

NOTE ON USING CIRCUIT DIAGRAMS

1. SAFETY

The components identified by the Δ symbol and shading are critical for safety. For continued safety replace safety critical components only with manufactures recommended parts.

2. SPECIFIED VOLTAGE AND WAVEFORM VALUES

The voltage and waveform values have been measured under the following conditions.

- (1) Input signal : Colour bar signal
 - (2) Setting positions of each knob/button and variable resistor : Original setting position when shipped
 - (3) Internal resistance of tester : DC 20k Ω /V
 - (4) Oscilloscope sweeping time : H \Rightarrow 20 μ S/div
: V \Rightarrow 5mS/div
: Others \Rightarrow Sweeping time is specified
 - (5) Voltage values : All DC voltage values
- * Since the voltage values of signal circuit vary to some extent according to adjustments, use them as reference values.

3. INDICATION OF PARTS SYMBOL [EXAMPLE]

- In the PW board : R1209 \rightarrow R209

4. INDICATIONS ON THE CIRCUIT DIAGRAM

(1) Resistors

● Resistance value

- No unit : [Ω]
- K : [K Ω]
- M : [M Ω]

● Rated allowable power

- No indication : 1/16[W]
- Others : As specified

● Type

- No indication : Carbon resistor
- OMR : Oxide metal film resistor
- MFR : Metal film resistor
- MPR : Metal plate resistor
- UNFR : Uninflammable resistor
- FR : Fusible resistor

* Composition resistor 1/2 [W] is specified as 1/2S or Comp.

(2) Capacitors

● Capacitance value

- 1 or higher : [pF]
- less than 1 : [μ F]

● Withstand voltage

- No indication : DC50[V]
- AC indicated : AC withstand voltage [V]
- Others : DC withstand voltage [V]

* Electrolytic Capacitors

47/50[Example]:Capacitance value [μ F]/withstand voltage[V]





● Type

- No indication : Ceramic capacitor
- MY : Mylar capacitor
- MM : Metalized mylar capacitor
- PP : Polypropylene capacitor
- MPP : Metalized polypropylene capacitor
- MF : Metalized film capacitor
- TF : Thin film capacitor
- BP : Bipolar electrolytic capacitor
- TAN : Tantalum capacitor

(3) Coils



- No unit : [μ H]
- Others : As specified

(4) Power Supply



-  : B1
-  : B2
-  : 9V
-  : 5V

* Respective voltage values are indicated





(5) Test point

-  : Test point
-  : Only test point display

(6) Connecting method

-  : Connector
-  : Wrapping or soldering
-  : Receptacle

(7) Ground symbol

-  : LIVE side ground
-  : ISOLATED (NEUTRAL) side ground
-  : EARTH ground
-  : DIGITAL ground

5. NOTE FOR REPAIRING SERVICE

This model's power circuit is partly different in the GND. The difference of the GND is shown by the LIVE : (\perp) side GND and the ISOLATED (NEUTRAL) : (\nwarrow) side GND. Therefore, care must be taken for the following points.

- (1) Do not touch the LIVE side GND or the LIVE side GND and the ISOLATED (NEUTRAL) side GND simultaneously. If the above caution is not respected, an electric shock may be caused. Therefore, make sure that the power cord is surely removed from the receptacle when, for example, the chassis is pulled out.
- (2) Do not short between the LIVE side GND and ISOLATED (NEUTRAL) side GND or never measure with a measuring apparatus (oscilloscope, etc.) the LIVE side GND and ISOLATED (NEUTRAL) side GND at the same time. If the above precaution is not respected, a fuse or any parts will be broken.

◇ Since the circuit diagram is a standard one, the circuit and circuit constants may be subject to change for improvement without any notice.

CONTENTS

SEMICONDUCTOR SHAPES 2-2

BLOCK DIAGRAM 2-3

CIRCUIT DIAGRAMS

INPUT PWB CIRCUIT DIAGRAM (1/2) 2-5

INPUT PWB CIRCUIT DIAGRAM (2/2) 2-7

MAIN & LINE FILTER PWB CIRCUIT DIAGRAM 2-9

MAIN & FRONT CONTROL PWB CIRCUIT DIAGRAM 2-11

CRT SOCKET PWB CIRCUIT DIAGRAM 2-13

PATTERN DIAGRAMS

MAIN PWB PATTERN [FX-1136A-H2] 2-15

INPUT PWB PATTERN [FX-6071A-H2] 2-17

FRONT CONTROL PWB PATTERN [FX-4067A-H2] 2-19

LINE FILTER PWB PATTERN [FX-9078A-H2] 2-19

CRT SOCKET PWB PATTERN [FX-3062A-H2] 2-20

SEMICONDUCTOR SHAPES

TRANSISTOR

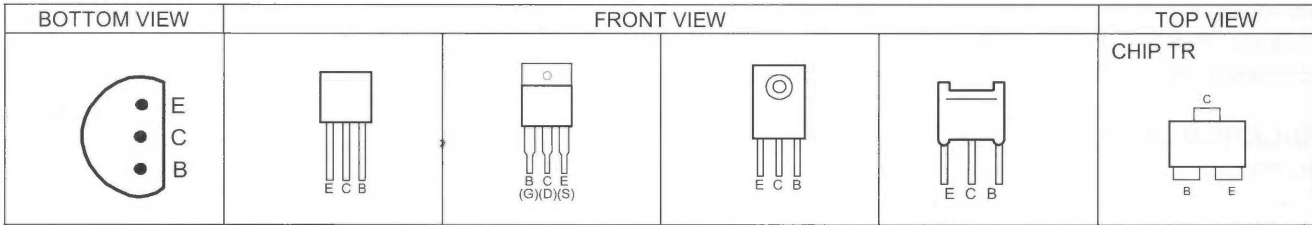

IC

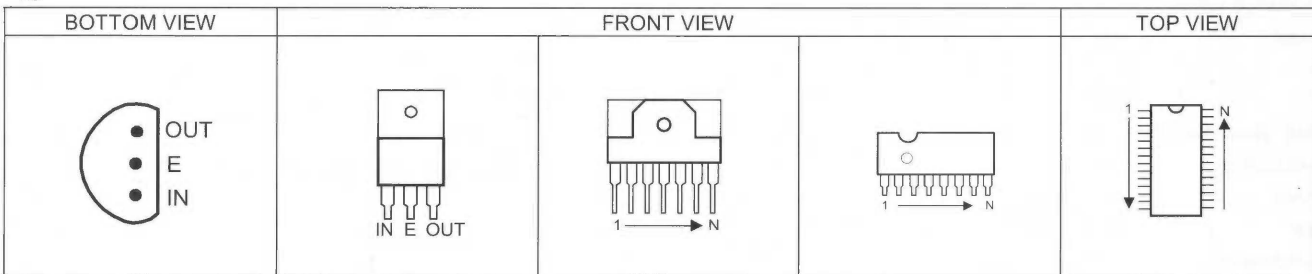

CHIP IC

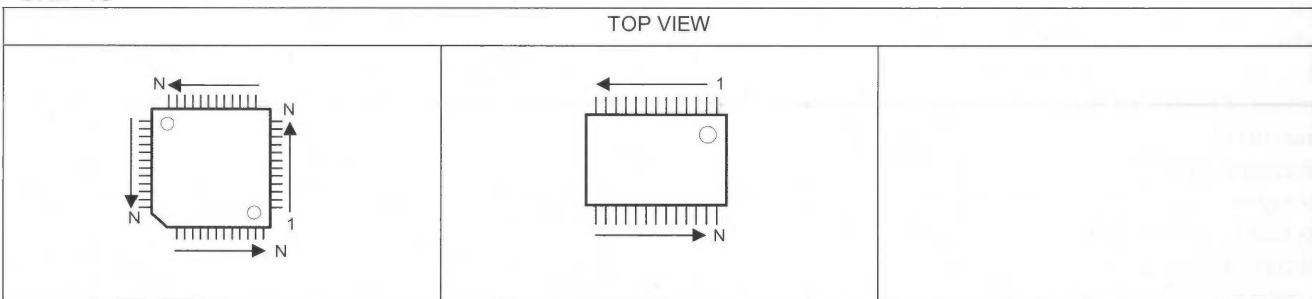

BLOCK DIAGRAM

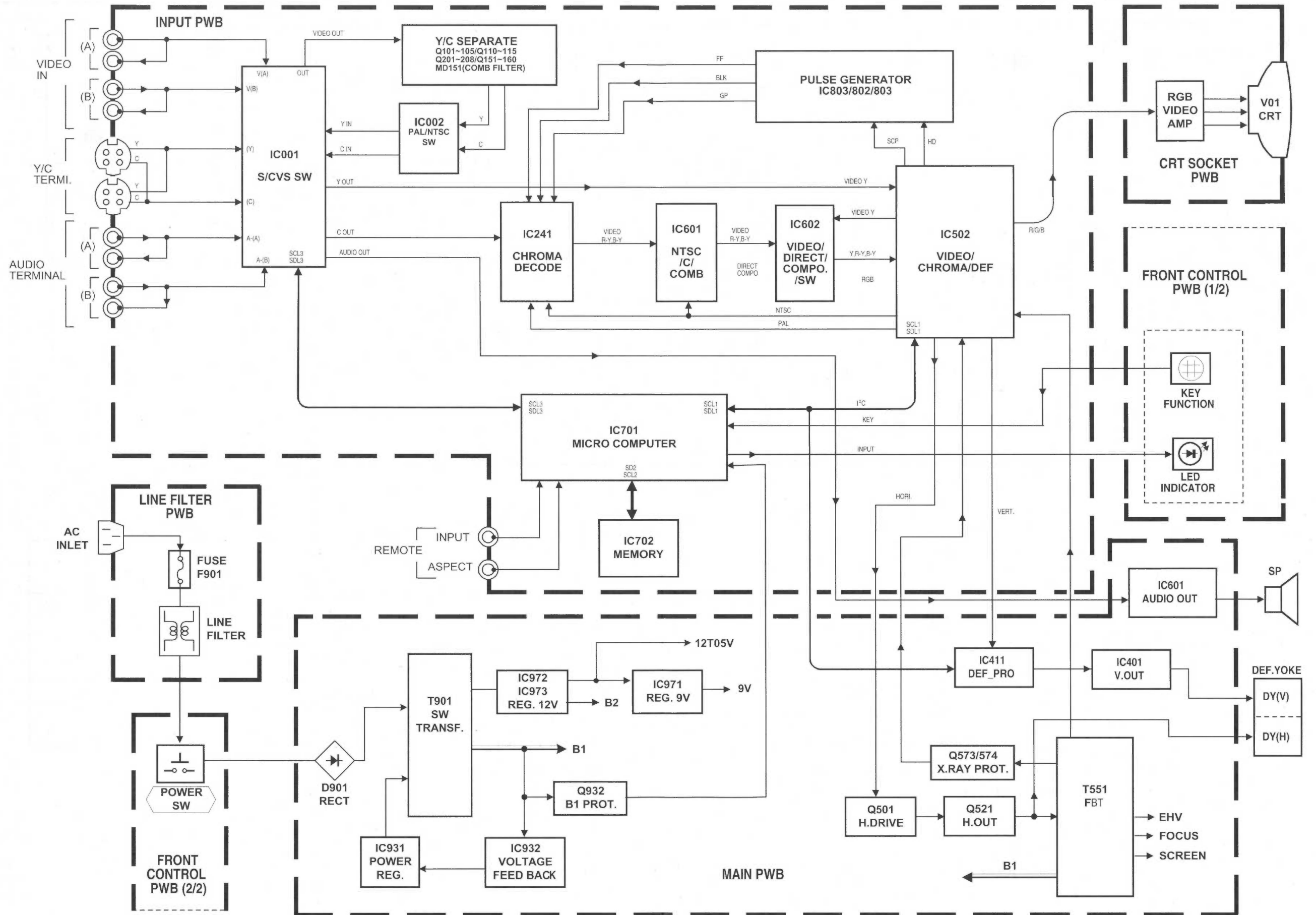

CIRCUIT DIAGRAMS [INPUT PWB CIRCUIT DIAGRAM] (1/2)

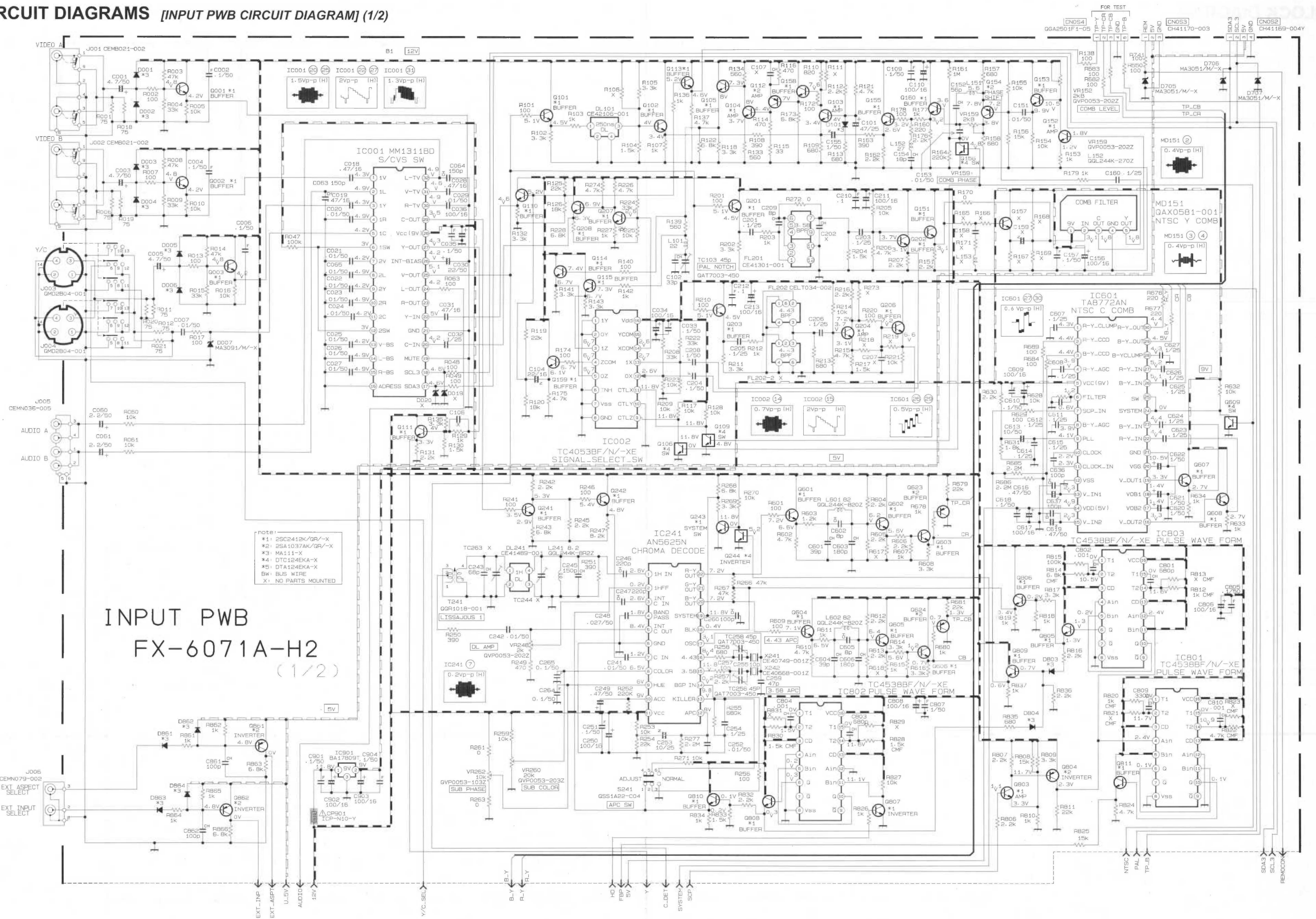

[INPUT PWB CIRCUIT DIAGRAM] (2/2)

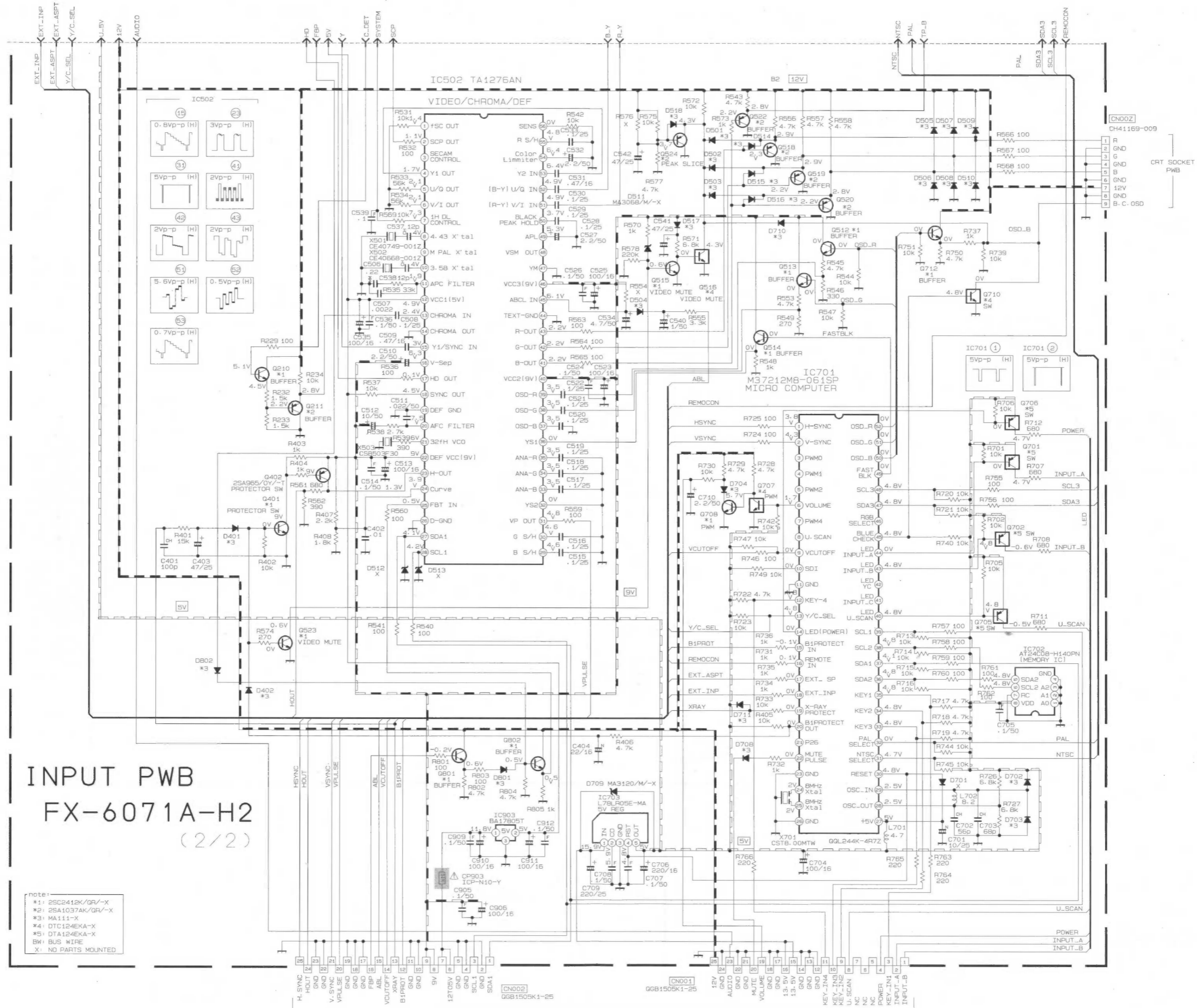

INPUT PWB
 FX-6071A-H2
 (2/2)

note:
 #1: 2SC2412K/GR/-X
 #2: 2SA1037AK/GA/-X
 #3: MA111-X
 #4: DTC124EKA-X
 #5: DTA124EKA-X
 BW: BUS WIRE
 X: NO PARTS MOUNTED

[MAIN & LINE FILTER PWB CIRCUIT DIAGRAM]

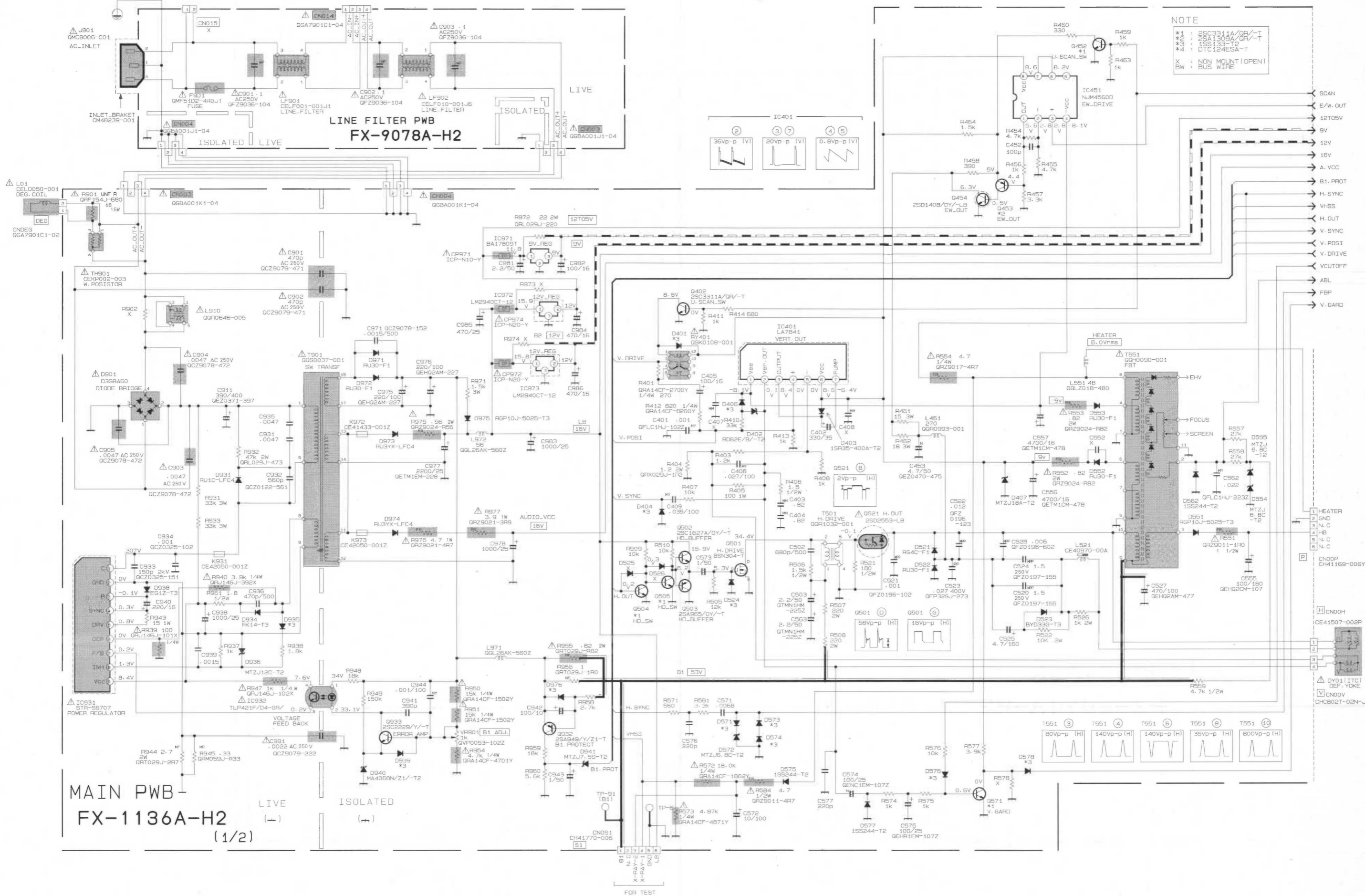

[MAIN & FRONT CONTROL PWB CIRCUIT DIAGRAM]

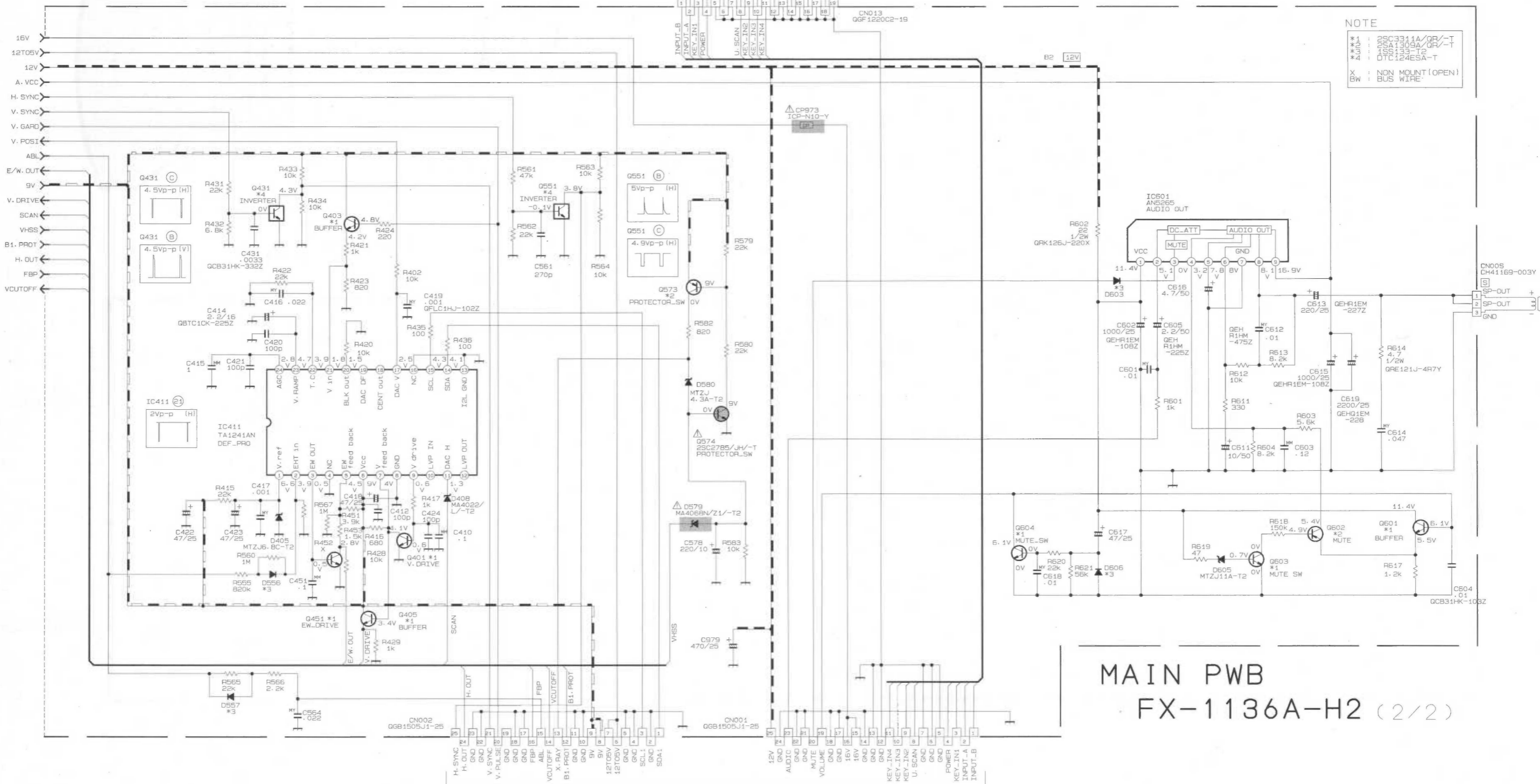
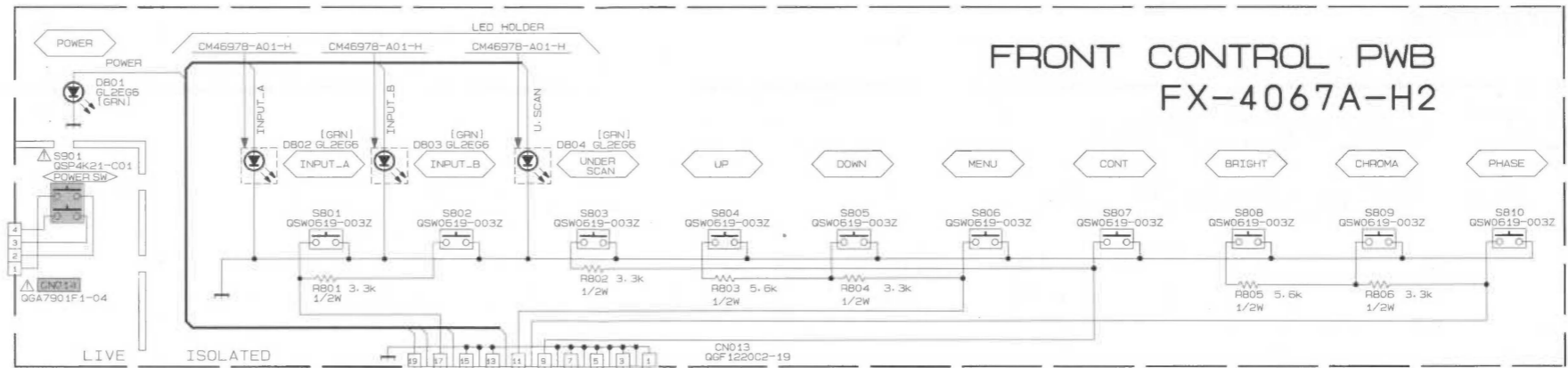

[CRT SOCKET PWB CIRCUIT DIAGRAM]

CRT SOCKET PWB FX-3062A-H2

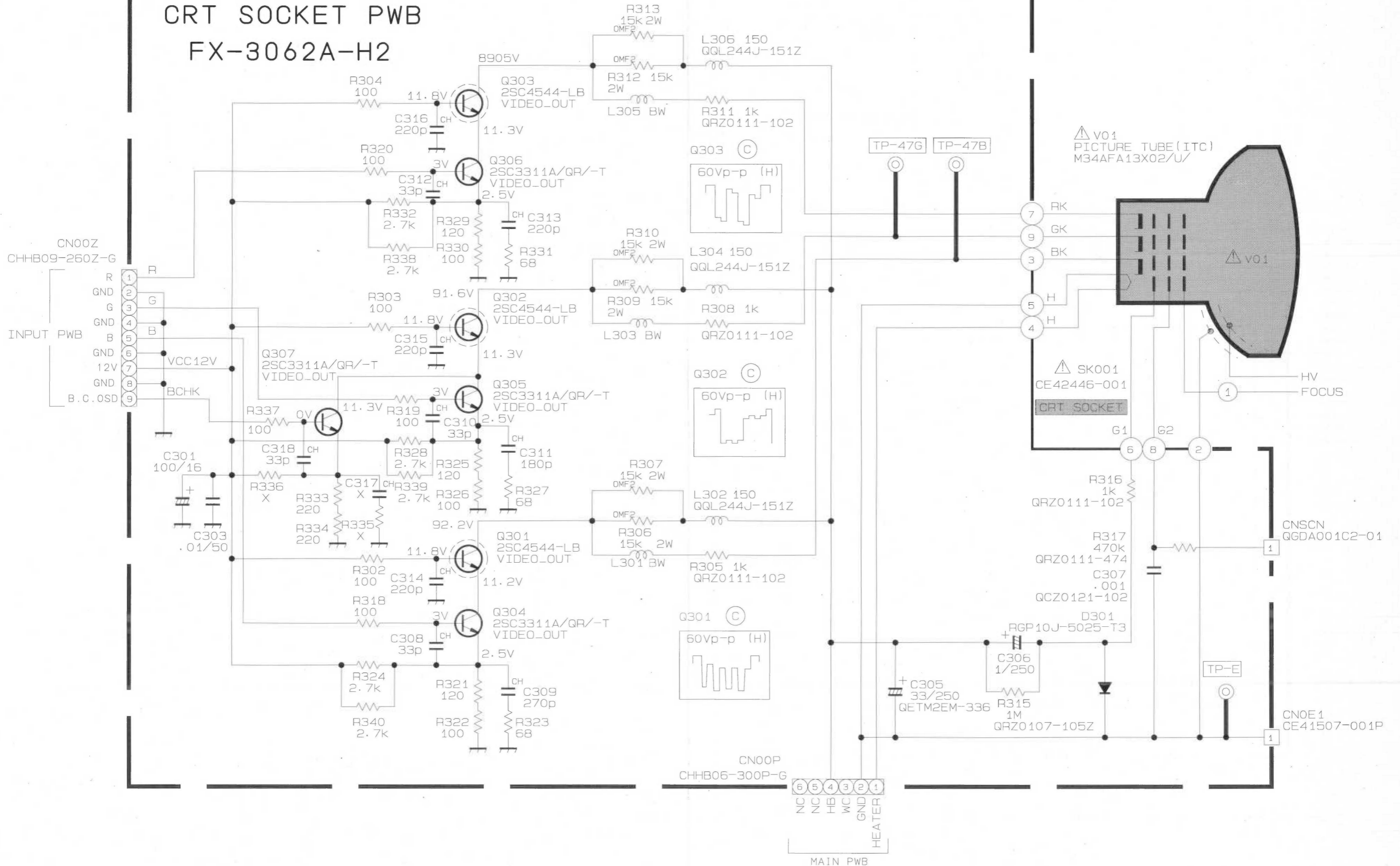

PATTERN DIAGRAMS [MAIN PWB PATTERN]

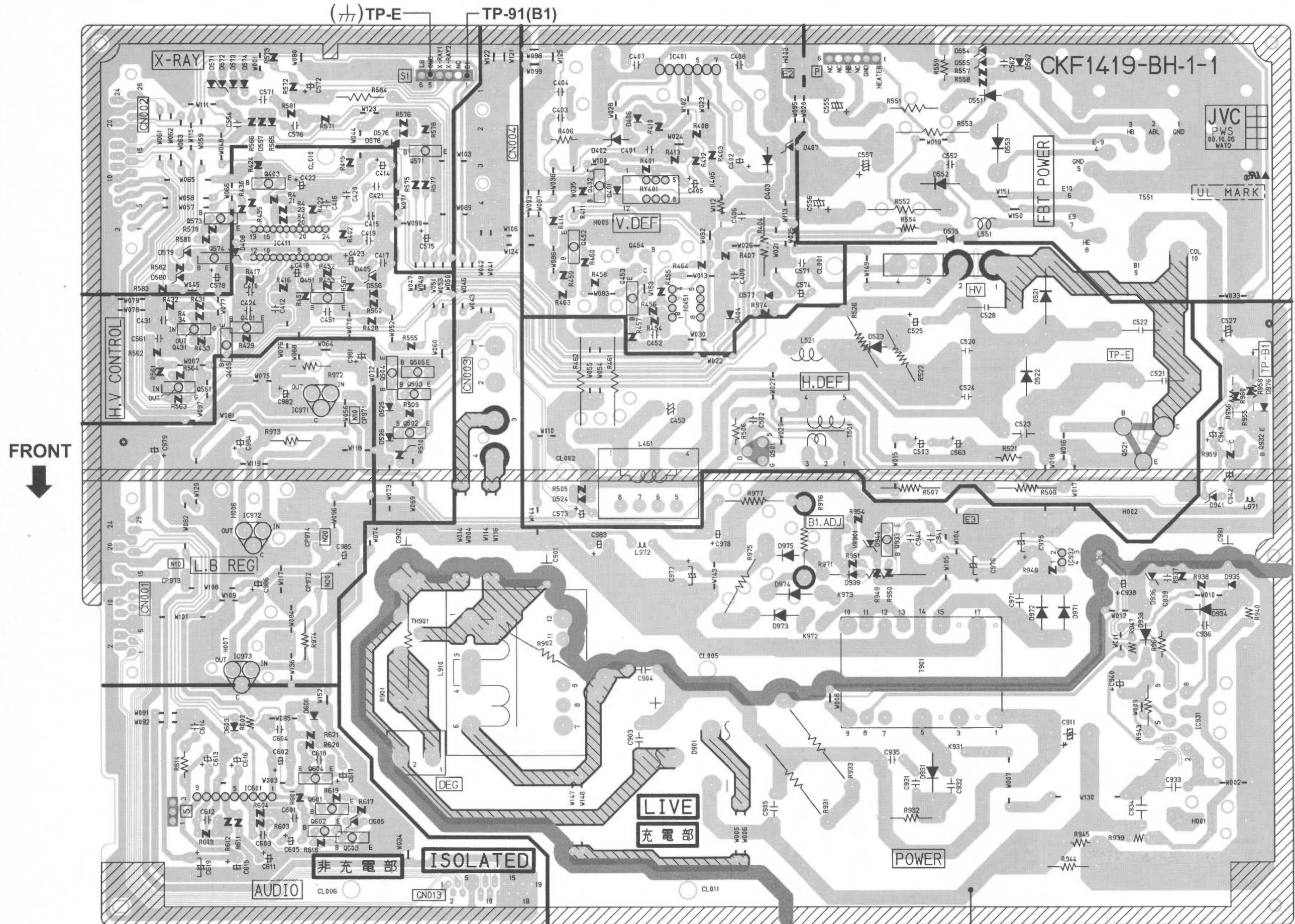

[INPUT PWB PATTERN]

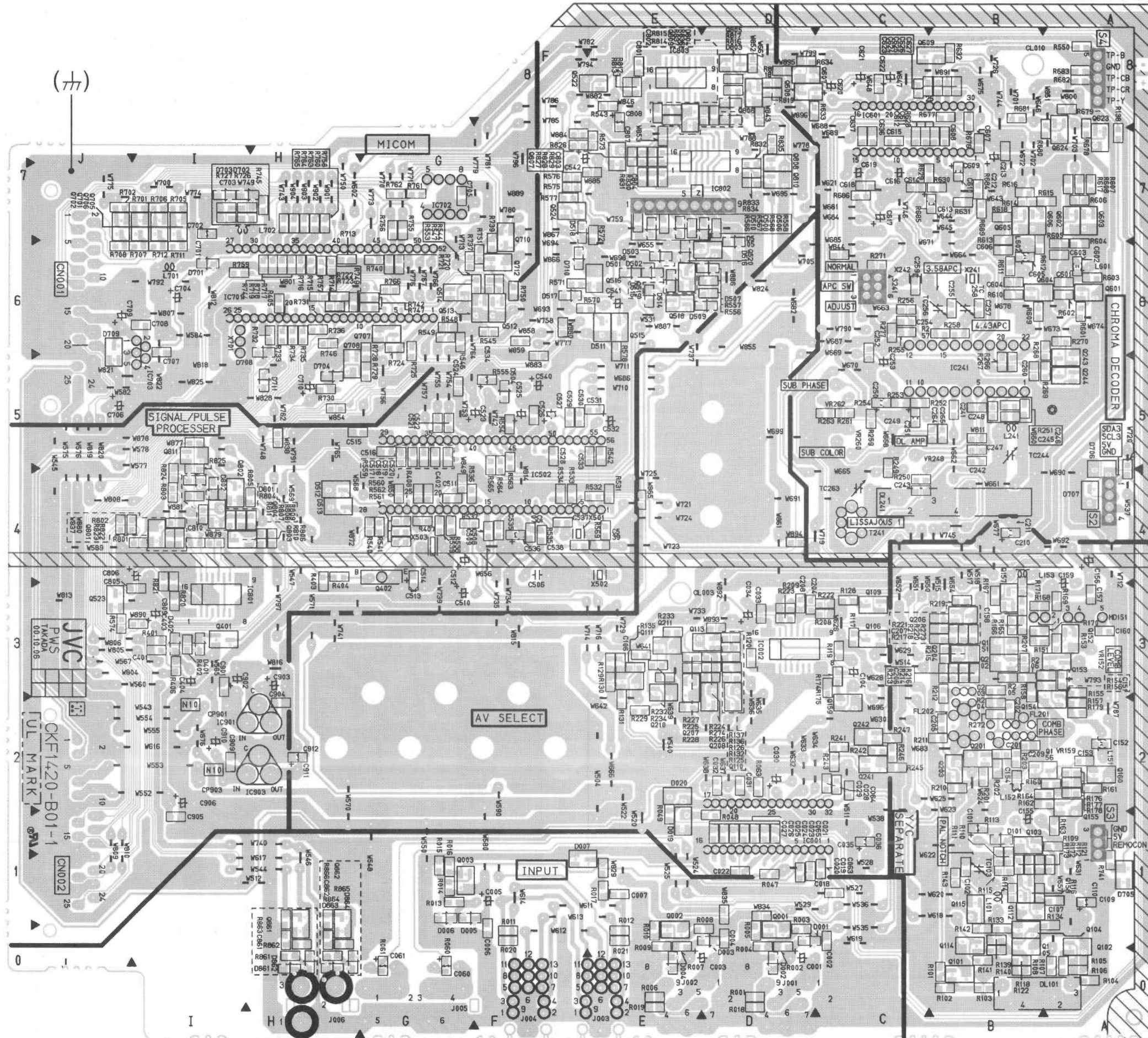

[FRONT CONTROL PWB PATTERN]

FRONT ←

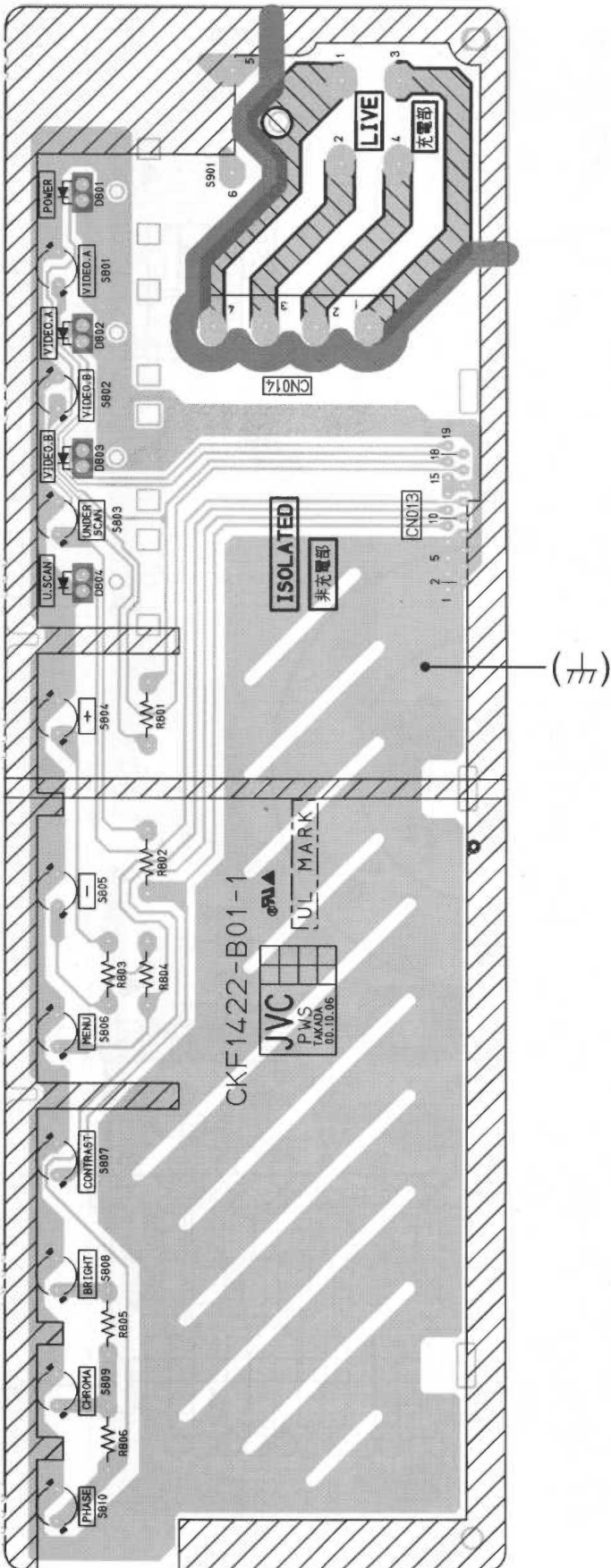

[LINE FILTER PWB PATTERN]

TOP ↑
FRONT ←

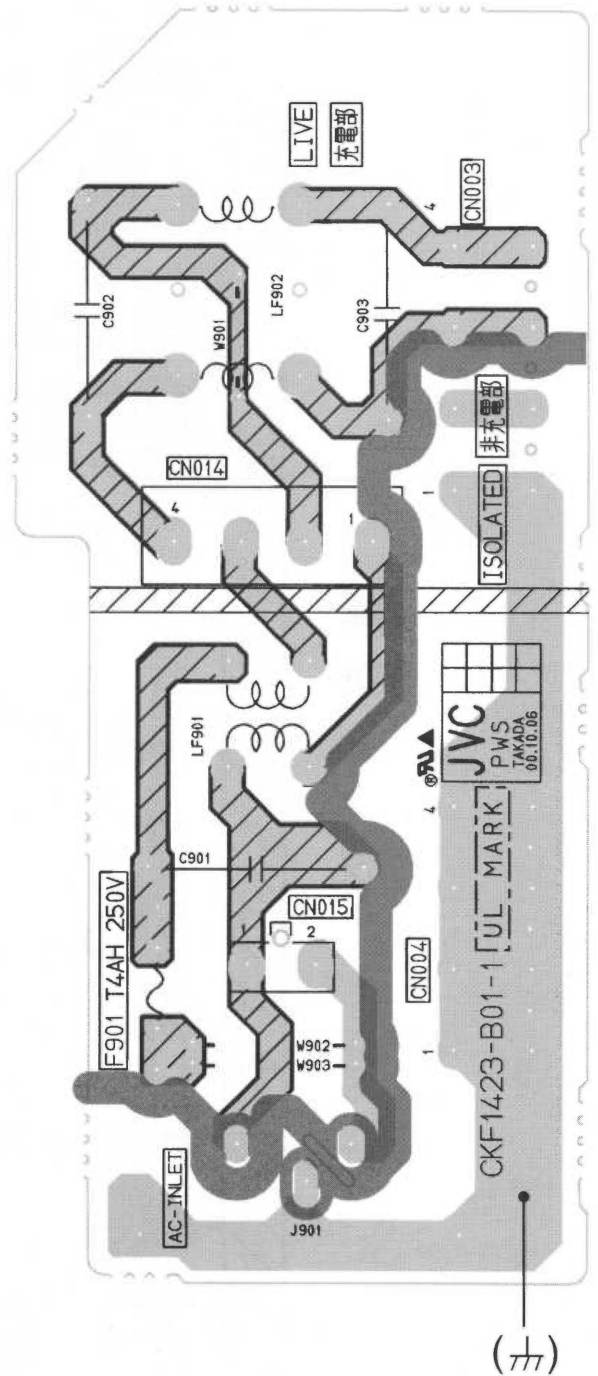

TOP ↑

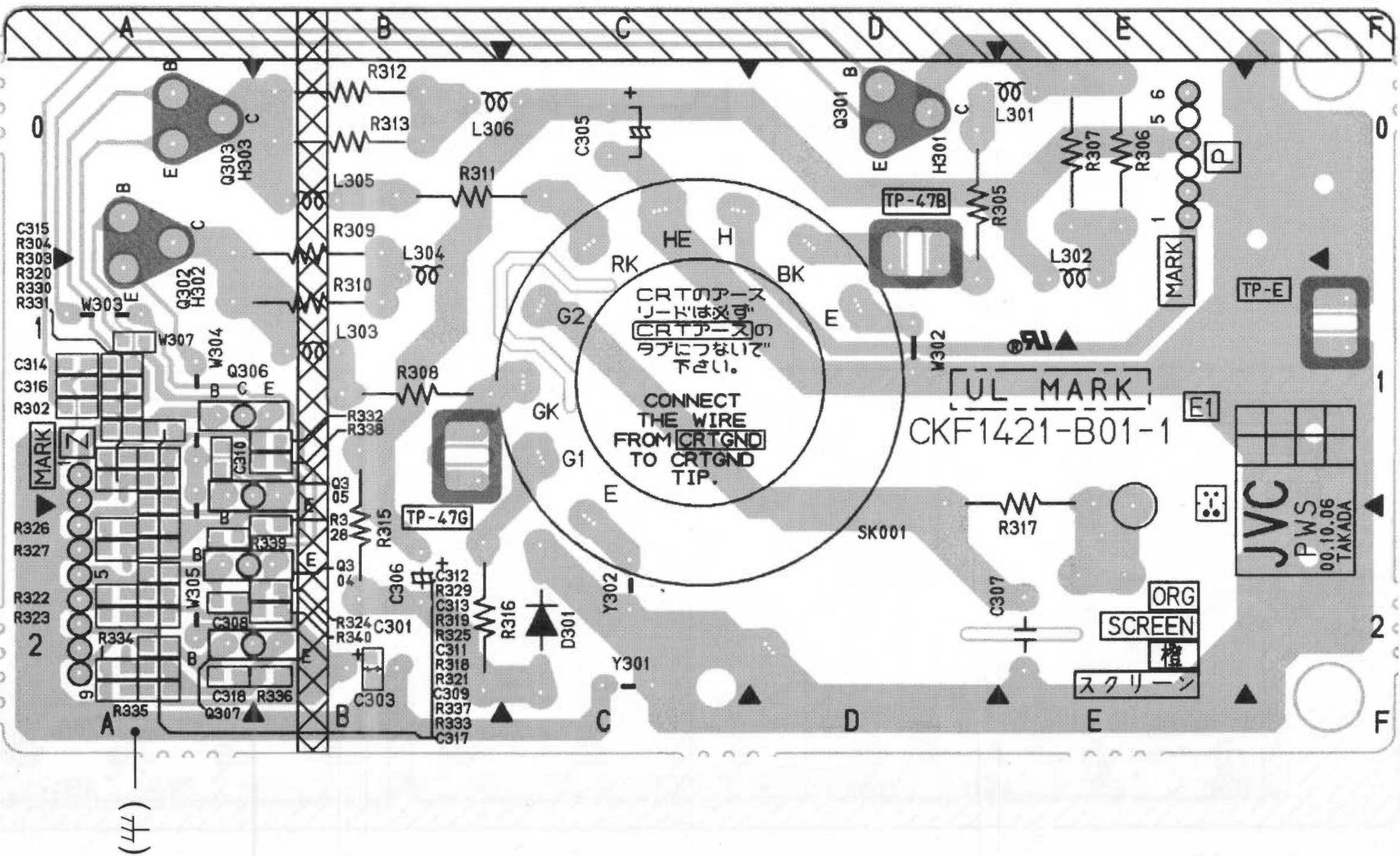

PARTS LIST

CAUTION

- The parts identified by the \triangle symbol are important for the safety. Whenever replacing these parts, be sure to use specified ones to secure the safety.
- The parts not indicated in this Parts List and those which are filled with lines —— in the Parts No. columns will not be supplied.
- P. W. Board Ass'y will not be supplied, but those which are filled with the Parts No. in the Parts No. columns will be supplied.

ABBREVIATIONS OF RESISTORS, CAPACITORS AND TOLERANCES

RESISTORS		CAPACITORS	
C R	Carbon Resistor	C CAP.	Ceramic Capacitor
F R	Fusible Resistor	E CAP.	Electrolytic Capacitor
P R	Plate Resistor	M CAP.	Mylar Capacitor
V R	Variable Resistor	HV CAP.	High Voltage Capacitor
HV R	High Voltage Resistor	MF CAP.	Metalized Film Capacitor
MF R	Metal Film Resistor	MM CAP.	Metalized Mylar Capacitor
MG R	Metal Glazed Resistor	MP CAP.	Metalized Polystyrol Capacitor
MP R	Metal Plate Resistor	PP CAP.	Polypropylene Capacitor
OM R	Metal Oxide Film Resistor	PS CAP.	Polystyrol Capacitor
CMF R	Coating Metal Film Resistor	TF CAP.	Thin Film Capacitor
UNF R	Non-Flammable Resistor	MPP CAP.	Metalized Polypropylene Capacitor
CH V R	Chip Variable Resistor	TAN. CAP.	Tantalum Capacitor
CH MG R	Chip Metal Glazed Resistor	CH C CAP.	Chip Ceramic Capacitor
COMP. R	Composition Resistor	BP E CAP.	Bi-Polar Electrolytic Capacitor
LPTC R	Linear Positive Temperature Coefficient Resistor	CH AL E CAP.	Chip Aluminum Electrolytic Capacitor
		CH AL BP CAP.	Chip Aluminum Bi-Polar Capacitor
		CH TAN. E CAP.	Chip Tantalum Electrolytic Capacitor
		CH AL BP E CAP.	Chip Tantalum Bi-Polar Electrolytic Capacitor

TOLERANCES									
F	G	J	K	M	N	R	H	Z	P
±1%	±2%	±5%	±10%	±20%	±30%	+30% -10%	+50% -10%	+80% -20%	+100% -0%

CONTENTS

- USING PW BOARD 39
- EXPLODED VIEW PARTS LIST 40
- EXPLODED VIEW [I] 40
- EXPLODED VIEW [II] 41
- PRINTED WIRING BOARD PARTS LIST
 - MAIN PW BOARD ASS'Y 42
 - CRT SOCKET PW BOARD ASS'Y 44
 - FRONT CONTROL PW BOARD ASS'Y 45
 - INPUT PW BOARD ASS'Y 45
 - LINE FILTER PW BOARD ASS'Y 49
- PACKING 50
- PACKING PARTS LIST 50

USING PW BOARD

PWB Name	PWB No.
MAIN PWB	FX-1136A-H2
CRT SOCKET PWB	FX-3062A-H2
FRONT CONTROL PWB	FX-4067A-H2
INPUT PWB	FX-6071A-H2
LINE FILTER PWB	FX-9078A-H2

EXPLODED VIEW PARTS LIST

△ Ref.No.	Part No.	Part Name	Description
△ L01	CELD050-001	DEGAUSSING COIL	
△ V01	M34AFA13X02/U/	ITC TUBE (C)	Inc.DY,WEDGE
△ T1551	QQH0090-001	HVT	Within MAIN PWB
△ J9901	QMCB006-C01	AC INLET	Within LINE FILTER PWB
△ 1	LC10295-004B-H	FRONT PANEL	
2	CM48149-A01	JVC MARK	
3	CM46756-A01	POWER KNOB	
4	LC20218-011A	CONTROL SHEET	
5	CM46757-001	SPRING	
6	LC20219-001A-C	SIDE BKT	(×2)
7	WJY0001-009A	E-BRAIDED ASSY	
8	A48457-3-H	SPRING	
9	CE42712-00A	P.C.MAGNET	
10	CM48241-001-H	KNOB CAP	
11	CHFB119-08BD	FFC WIRE	
12	CEBS508P-01KJ2	SPEAKER	SP01
13	CHGS0003-0B-FH	SPEAKER WIRE	
△ 15	LC10962-001B	CHASSIS BASE	
16	LC31363-001A	FBT HOLDER	
△ 20	CHGT0011-AA	RECEP WIRE ASSY	(SPIRAL)
21	LC10963-002A-H	TERMINAL BRACKET	
22	QYSBSB3010M	TAPPING SCREW	(×6)
24	CM44287-00B	ASSY SCREW	
25	LC10298-001A-C	BOTTOM COVER	
26	CM44287-00C	ASSY SCREW	(×2)
27	CM47686-00A	FOOT	(×4)
28	LC10992-002A-H	REAR PANEL	
29	CM44287-00C	ASSY SCREW	(×3)
30	QYSBSF4012Z	TAPPING SCREW	
31	CM44287-00C	ASSY SCREW	(×7)
32	CM44287-00C	ASSY SCREW	(×4)
33	LC10296-008A-H	TOP COVER	(SERVICE)
△ 34	LC20405-012A-0L	ROLL R LABEL	

EXPLODED VIEW [I]

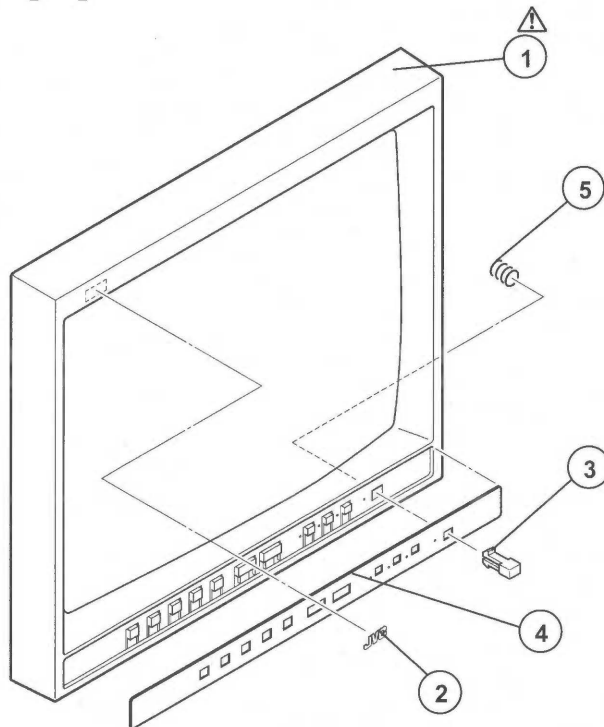

EXPLODED VIEW [II]

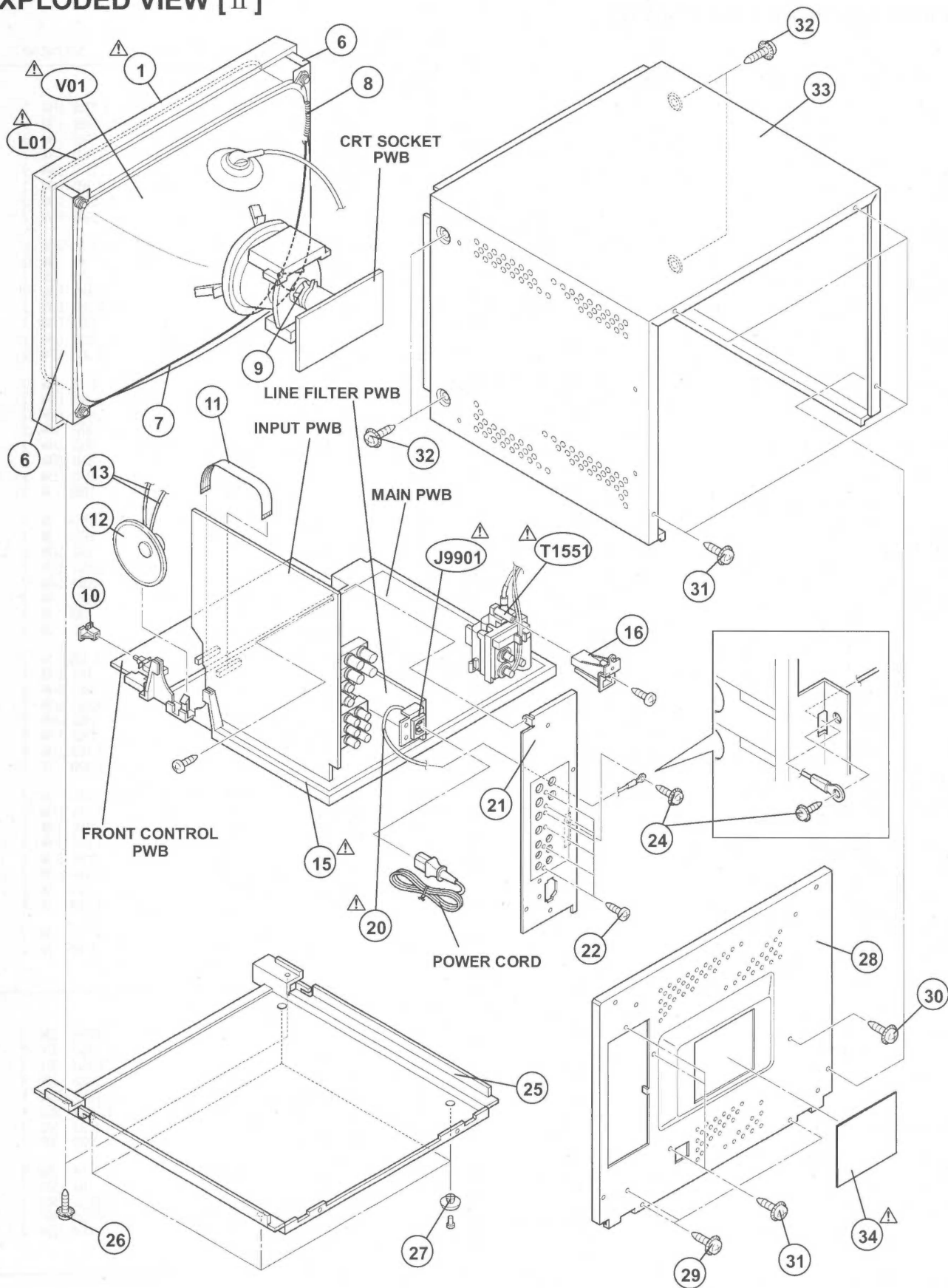

PRINTED WIRING BOARD PARTS LIST

MAIN PW BOARD ASS'Y (FX-1136A-H2)

△ Symbol No.	Part No.	Part Name	Description
VARIABLE RESISTOR			
VR1901	QVP0053-102Z	V R(B1 ADJ.)	
RESISTOR			
R1401	QRA14CF-2700Y	MF R	270Ω 1/4W F
R1402	QRE141J-103Y	C R	10kΩ 1/4W J
R1403	QRE141J-122Y	C R	1.2kΩ 1/4W J
R1404	QRX029J-1R2	MF R	1.2Ω 2W J
R1405	QRG01GJ-101	OM R	100Ω 1W J
R1406	QRE121J-1R5Y	C R	1.5Ω 1/2W J
R1407	QRE141J-103Y	C R	10kΩ 1/4W J
R1408	QRE141J-102Y	C R	1kΩ 1/4W J
R1410	QRE141J-333Y	C R	33kΩ 1/4W J
R1411	QRE141J-102Y	C R	1kΩ 1/4W J
R1412	QRA14CF-8200Y	MF R	820Ω 1/4W F
R1413	QRE141J-102Y	C R	1kΩ 1/4W J
R1414	QRE141J-681Y	C R	680Ω 1/4W J
R1415	QRE141J-223Y	C R	22kΩ 1/4W J
R1416	QRE141J-681Y	C R	680Ω 1/4W J
R1417	QRE141J-102Y	C R	1kΩ 1/4W J
R1420	QRE141J-103Y	C R	10kΩ 1/4W J
R1421	QRE141J-102Y	C R	1kΩ 1/4W J
R1422	QRE141J-223Y	C R	22kΩ 1/4W J
R1423	QRE141J-821Y	C R	820Ω 1/4W J
R1424	QRE141J-221Y	C R	220Ω 1/4W J
R1428	QRE141J-103Y	C R	10kΩ 1/4W J
R1429	QRE141J-102Y	C R	1kΩ 1/4W J
R1431	QRE141J-223Y	C R	22kΩ 1/4W J
R1432	QRE141J-682Y	C R	6.8kΩ 1/4W J
R1433-34	QRE141J-103Y	C R	10kΩ 1/4W J
R1435-36	QRE141J-101Y	C R	100Ω 1/4W J
R1451	QRE141J-392Y	C R	3.9kΩ 1/4W J
R1453	QRE141J-152Y	C R	1.5kΩ 1/4W J
R1454-55	QRE141J-472Y	C R	4.7kΩ 1/4W J
R1456	QRE141J-102Y	C R	1kΩ 1/4W J
R1457	QRE141J-332Y	C R	3.3kΩ 1/4W J
R1458	QRE141J-391Y	C R	390Ω 1/4W J
R1459	QRE141J-102Y	C R	1kΩ 1/4W J
R1460	QRE141J-331Y	C R	330Ω 1/4W J
R1461	QRG039J-150	OM R	15Ω 3W J
R1462	QRG039J-180	OM R	18Ω 3W J
R1463	QRE141J-102Y	C R	1kΩ 1/4W J
R1464	QRE141J-152Y	C R	1.5kΩ 1/4W J
R1505	QRE141J-123Y	C R	12kΩ 1/4W J
R1506	QRE121J-152Y	C R	1.5kΩ 1/2W J
R1507-08	QRG029J-221	OM R	220 Ω 2W J
R1509-10	QRE141J-103Y	C R	10kΩ 1/4W J
R1521	QRE121J-181Y	C R	180Ω 1/2W J
R1522	QRG029J-103	OM R	10kΩ 2W J
R1526	QRG029J-102	OM R	1kΩ 2W J
△ R1551	QRZ9011-1R0	F R	1Ω 1/2W J
△ R1552	QRZ9024-R82	F R	0.82Ω 2W K
△ R1553	QRZ9024-R82	F R	0.82Ω 2W K
△ R1554	QRZ9017-4R7	F R	4.7Ω 1/4W J
R1555	QRE141J-824Y	C R	820kΩ 1/4W J
R1557-58	QRE141J-273Y	C R	27kΩ 1/4W J
R1559	QRE121J-472Y	C R	4.7kΩ 1/2W J
R1560	QRE141J-105Y	C R	1MΩ 1/4W J
R1561	QRE141J-473Y	C R	47kΩ 1/4W J
R1562	QRE141J-223Y	C R	22kΩ 1/4W J
R1563-64	QRE141J-103Y	C R	10kΩ 1/4W J
R1565	QRE141J-223Y	C R	22kΩ 1/4W J
R1566	QRE141J-222Y	C R	2.2kΩ 1/4W J
R1567	QRE141J-105Y	C R	1MΩ 1/4W J
R1571	QRE141J-561Y	C R	560Ω 1/4W J
△ R1572	QRA14CF-1802Y	MF R	18kΩ 1/4W F

△ Symbol No.	Part No.	Part Name	Description
RESISTOR			
△ R1573	QRA14CF-4871Y	MF R	4.87kΩ 1/4W F
R1574-75	QRE141J-102Y	C R	1kΩ 1/4W J
R1576	QRE141J-103Y	C R	10kΩ 1/4W J
R1577	QRE141J-392Y	C R	3.9kΩ 1/4W J
R1579-80	QRE141J-223Y	C R	22kΩ 1/4W J
R1581	QRE141J-332Y	C R	3.3kΩ 1/4W J
R1582	QRE141J-821Y	C R	820Ω 1/4W J
R1583	QRE141J-103Y	C R	10kΩ 1/4W J
△ R1584	QRZ9011-4R7	F R	4.7Ω 1/2W J
R1601	QRE141J-102Y	C R	1kΩ 1/4W J
R1602	QRK126J-220X	C R	22Ω 1/2W J
R1603	QRE141J-562Y	C R	5.6kΩ 1/4W J
R1604	QRE141J-822Y	C R	8.2kΩ 1/4W J
R1611	QRE141J-331Y	C R	330Ω 1/4W J
R1612	QRE141J-103Y	C R	10kΩ 1/4W J
R1613	QRE141J-822Y	C R	8.2kΩ 1/4W J
R1614	QRE121J-4R7Y	C R	4.7Ω 1/2W J
R1617	QRE141J-122Y	C R	1.2kΩ 1/4W J
R1618	QRE141J-154Y	C R	150kΩ 1/4W J
R1619	QRE141J-470Y	C R	47Ω 1/4W J
R1620	QRE141J-223Y	C R	22kΩ 1/4W J
R1621	QRE141J-563Y	C R	56kΩ 1/4W J
△ R1901	QRF154J-680	UNF R	68 Ω 15W J
R1931	QRG039J-333	OM R	33kΩ 3W J
R1932	QRL029J-473	OM R	47kΩ 2W J
R1933	QRG039J-333	OM R	33kΩ 3W J
R1937	QRE141J-102Y	C R	1kΩ 1/4W J
R1938	QRE141J-182Y	C R	1.8kΩ 1/4W J
△ R1939	QRJ146J-101X	C R	100Ω 1/4W J
△ R1940	QRJ146J-392X	C R	3.9kΩ 1/4W J
R1943	QRG01GJ-150	OM R	15Ω 1W J
R1944	QRT029J-2R7	MF R	2.7Ω 2W J
R1945	QRM059J-R33	MP R	0.33Ω 5W J
△ R1947	QRJ146J-102X	C R	1kΩ 1/4W J
R1948	QRE141J-183Y	C R	18kΩ 1/4W J
R1949	QRE141J-154Y	C R	150kΩ 1/4W J
△ R1950	QRA14CF-1502Y	MF R	15kΩ 1/4W F
△ R1951	QRA14CF-1502Y	MF R	15kΩ 1/4W F
△ R1954	QRA14CF-4701Y	MF R	4.7kΩ 1/4W F
△ R1955	QRT029J-R82	MF R	0.82Ω 2W J
R1956	QRT029J-1R0	MF R	1.0Ω 2W J
R1958	QRE141J-272Y	C R	2.7kΩ 1/4W J
R1959	QRE141J-183Y	C R	18kΩ 1/4W J
R1960	QRE141J-562Y	C R	5.6kΩ 1/4W J
R1961	QRE121J-1R8Y	C R	1.8Ω 1/2W J
R1971	QRG039J-152	OM R	1.5kΩ 3W J
R1972	QRL029J-220	OM R	22Ω 2W J
△ R1975	QRZ9024-R56	F R	0.56Ω 2W K
△ R1976	QRZ9021-4R7	F R	4.7 Ω 1W J
△ R1977	QRZ9021-3R9	F R	3.9Ω 1W J
CAPACITOR			
C1401	QFLC1HJ-102Z	M CAP.	1000pF 50V J
C1402	QETN1VM-337Z	E CAP.	330μF 35V M
C1403-04	QFV71HJ-824Z	MF CAP.	0.82μF 50V J
C1405	QETN1CM-107Z	E CAP.	100μF 16V M
C1406	QFLC2AK-273Z	M CAP.	0.027μF 100V K
C1409	QFLC2AK-393Z	M CAP.	0.039μF 100V K
C1410	QFV71HJ-104Z	MF CAP.	0.1μF 50V J
C1412	QCS31HJ-101Z	C CAP.	100pF 50V J
C1414	QBTC1CK-225Z	TAN. CAP.	2.2μF 16V K
C1415	QFV71HJ-105Z	MF CAP.	1μF 50V J
C1416	QFLC1HJ-223Z	M CAP.	0.022μF 50V J
C1417	QFLC1HJ-102Z	M CAP.	1000pF 50V J
C1418	QETN1EM-476Z	E CAP.	47μF 25V M

△ Symbol No. Part No. Part Name Description

CAPACITOR

C1419	QFLC1HJ-102Z	M CAP.	1000pF 50V J
C1420-21	QCS31HJ-101Z	C CAP.	100pF 50V J
C1422-23	QETN1EM-476Z	E CAP.	47μF 25V M
C1424	QCS31HJ-101Z	C CAP.	100pF 50V J
C1431	QCB31HK-332Z	C CAP.	3300pF 50V K
C1451	QFV71HJ-104Z	MF CAP.	0.1μF 50V J
C1452	QCS31HJ-101Z	C CAP.	100pF 50V J
C1453	QEZ0470-475	E CAP.	4.7μF 50V M
C1502	QCB32HK-681Z	C CAP.	680pF 500V K
C1503	QTMN1HM-225Z	E CAP.	2.2μF 50V M
C1520	QFZ0197-155	MPP CAP.	1.5μF 250V J
C1521	QFZ0196-102	MPP CAP.	1000pF1.5KVH ±3%
C1522	QFZ0196-123	MPP CAP.	0.012F1.5KVH ±3%
C1523	QFP32GJ-273	PP CAP.	0.027μF 400V J
C1524	QFZ0197-155	MPP CAP.	1.5μF 250V J
C1525	QETN2CM-475Z	E CAP.	4.7μF 160V M
C1527	QEHQ2AM-477	E CAP.	470μF 100V M
C1528	QFZ0196-602	MPP CAP.	6000pF1.5KVH ±3%
C1555	QEHQ2CM-107	E CAP.	100μF 160V M
C1556-57	QETN1CM-478	E CAP.	4700μF 16V M
C1561	QCS31HJ-271Z	C CAP.	270pF 50V J
C1562	QFLC1HJ-223Z	M CAP.	0.022μF 50V J
C1563	QTMN1HM-225Z	E CAP.	2.2μF 50V M
C1564	QFLC1HJ-223Z	M CAP.	0.022μF 50V J
C1571	QCB31HK-682Z	C CAP.	6800pF 50V K
C1572	QETN2AM-106Z	E CAP.	10μF 100V M
C1573	QETN1HM-105Z	E CAP.	1μF 50V M
C1574	QENC1EM-107Z	BP E CAP.	100μF 25V M
C1575	QEHRIEM-107Z	E CAP.	100μF 25V M
C1576-77	QCS31HJ-221Z	C CAP.	220pF 50V J
C1578	QETN1AM-227Z	E CAP.	220μF 10V M
C1601	QFLC1HJ-103Z	M CAP.	0.01μF 50V J
C1602	QEHRIEM-108Z	E CAP.	1000μF 25V M
C1603	QFV71HJ-124Z	MF CAP.	0.12μF 50V J
C1604	QCB31HK-103Z	C CAP.	0.01μF 50V K
C1605	QEHRIEM-225Z	E CAP.	2.2μF 50V M
C1611	QETN1HM-106Z	E CAP.	10μF 50V M
C1612	QFLC1HJ-103Z	M CAP.	0.01μF 50V J
C1613	QEHRIEM-227Z	E CAP.	220μF 25V M
C1614	QFLC1HJ-473Z	M CAP.	0.047μF 50V J
C1615	QEHRIEM-108Z	E CAP.	1000μF 25V M
C1616	QEHRIEM-475Z	E CAP.	4.7μF 50V M
C1617	QETN1EM-476Z	E CAP.	47μF 25V M
C1618	QFLC1HJ-103Z	M CAP.	0.01μF 50V J
C1619	QEHQ1EM-228	E CAP.	2200μF 25V M
△ C1901	QCZ9079-471	C CAP.	470pFAC250V K
△ C1902	QCZ9079-471	C CAP.	470pFAC250V K
△ C1903	QCZ9078-472	C CAP.	4700pFAC250V M
△ C1904	QCZ9078-472	C CAP.	4700pFAC250V M
△ C1905	QCZ9078-472	C CAP.	4700pFAC250V M
C1911	QEZ0371-397	E CAP.	390μF 400V M
C1931	QCB32HK-472Z	C CAP.	4700pF 500V K
C1932	QCZ0122-561	C CAP.	560pF 2kV K
C1933	QCZ0325-151	C CAP.	150pF 2kV K
C1934	QCZ0325-102	C CAP.	1000pF 2kV K
C1935	QCB32HK-472Z	C CAP.	4700pF 500V K
C1936	QCB32HK-471Z	C CAP.	470pF 500V K
C1938	QETN1EM-108Z	E CAP.	1000μF 25V M
C1939	QCB31HK-152Z	C CAP.	1500pF 50V K
C1940	QETN1CM-227Z	E CAP.	220μF 16V M
C1941	QCS31HJ-391Z	C CAP.	390pF 50V J
C1942	QETN1AM-107Z	E CAP.	100μF 10V M
C1943	QETN1HM-105Z	E CAP.	1μF 50V M
C1944	QFN32AK-102Z	M CAP.	1000pF 100V K
C1971	QCZ9078-152	C CAP.	1500pFAC250V M
C1975-76	QEHQ2AM-227	E CAP.	220μF 100V M
C1977	QETN1EM-228	E CAP.	2200μF 25V M
C1978	QETN1EM-108Z	E CAP.	1000μF 25V M
C1979	QETN1EM-477Z	E CAP.	470μF 25V M
C1981	QETN1HM-225Z	E CAP.	2.2μF 50V M

△ Symbol No. Part No. Part Name Description

CAPACITOR

C1982	QETN1CM-107Z	E CAP.	100μF 16V M
C1983	QETN1EM-108Z	E CAP.	1000μF 25V M
C1984	QETN1CM-477Z	E CAP.	470μF 16V M
C1985	QETN1EM-477Z	E CAP.	470μF 25V M
C1986	QETN1CM-477Z	E CAP.	470μF 16V M
△ C1991	QCZ9079-22Z	C CAP.	2200pFAC250V M

TRANSFORMER

T1501	QQR1032-001	H.DRIVE TRANSF.	
△ T1551	QQH0090-001	FBT	
△ T1901	QQS0037-001	SWITCH.TRANSF.	

COIL

L1461	QQR0993-001	CHOKE COIL	
L1521	CE40970-00A	LINEARITY COIL	
L1551	QQLZ018-480	HEATER CHOKE	
△ L1910	QQR0646-005	CHOKE COIL	
L1971-72	QQL26AK-560Z	CHOKE COIL	

DIODE

D1401	1SS133-T2	SI.DIODE	
D1402	RD62E/B/-T2	ZENER DIODE	
D1403	1SR35-400A-T2	SI.DIODE	
D1404	1SS133-T2	SI.DIODE	
D1405	MTZJ6.8C-T2	ZENER DIODE	
D1406	1SS133-T2	SI.DIODE	
D1407	MTZJ18A-T2	ZENER DIODE	
D1408	MA4022/L/-T2	ZENER DIODE	
D1521	RG4C-F1	SI.DIODE	
D1522	RU30-F1	SI.DIODE	
D1523	BYD33G-T3	SI.DIODE	
D1524	1SS133-T2	SI.DIODE	
D1551	RGP10J-5025-T3	SI.DIODE	
D1552-53	RU30-F1	SI.DIODE	
D1554-55	MTZJ6.8C-T2	ZENER DIODE	
D1556-57	1SS133-T2	SI.DIODE	
D1562	1SS244-T2	SI.DIODE	
D1571	1SS133-T2	SI.DIODE	
D1572	MTZJ6.8C-T2	ZENER DIODE	
D1573-74	1SS133-T2	SI.DIODE	
D1575	1SS244-T2	SI.DIODE	
D1576	1SS133-T2	SI.DIODE	
D1577	1SS244-T2	SI.DIODE	
D1578	1SS133-T2	SI.DIODE	
△ D1579	MA4068N/Z1/-T2	ZENER DIODE	
D1580	MTZJ4.3A-T2	ZENER DIODE	
D1603	1SS133-T2	SI.DIODE	
D1605	MTZJ11A-T2	ZENER DIODE	
D1606	1SS133-T2	SI.DIODE	
△ D1901	D3SBA60	DIODE BRIDGE	
D1931	RU1C-LFC4	SI.DIODE	
D1934	RK14-T3	SI.DIODE	
D1935	1SS133-T2	SI.DIODE	
D1936	MTZJ12C-T2	ZENER DIODE	
D1938	EG1Z-T3	SI.DIODE	
D1939	1SS133-T2	SI.DIODE	
D1940	MA4068N/Z1/-T2	ZENER DIODE	
D1941	MTZJ7.55-T2	ZENER DIODE	
D1971-72	RU30-F1	SI.DIODE	
D1973-74	RU3YX-LFC4	SI.DIODE	
D1975	RGP10J-5025-T3	SI.DIODE	
D1976	1SS133-T2	SI.DIODE	

Symbol No.	Part No.	Part Name	Description
TRANSISTOR			
Q1401-03	25C3311A/QR/-T	SI. TRANSISTOR	
Q1405	25C3311A/QR/-T	SI. TRANSISTOR	
Q1431	DTC124ESA-T	DIGI. TRANSISTOR	
Q1451-52	25C3311A/QR/-T	SI. TRANSISTOR	
Q1453	25A1309A/QR/-T	SI. TRANSISTOR	
Q1454	25D1408/OY/-LB	SI. TRANSISTOR	
Q1501	BSN304-T	F. E. T.	
Q1502	25C1627A/OY/-T	SI. TRANSISTOR	
Q1503	25A965/OY/-T	SI. TRANSISTOR	
Q1504-05	25C3311A/QR/-T	SI. TRANSISTOR	H. OUT
Q1521	25D2553-LB	SI. TRANSISTOR	
Q1551	DTC124ESA-T	DIGI. TRANSISTOR	
Q1571	25C3311A/QR/-T	SI. TRANSISTOR	
Q1573	25A1309A/QR/-T	SI. TRANSISTOR	
Q1574	25C2785/JH/-T	SI. TRANSISTOR	
Q1601	25C3311A/QR/-T	SI. TRANSISTOR	
Q1602	25A1309A/QR/-T	SI. TRANSISTOR	
Q1603-04	25C3311A/QR/-T	SI. TRANSISTOR	
Q1932	25A949/Y/Z1-T	SI. TRANSISTOR	
Q1933	25C2229/Y/-T	SI. TRANSISTOR	

Symbol No.	Part No.	Part Name	Description
IC			
IC1401	LA7841	I. C. (MONO-ANA)	
IC1411	TA1241AM	I. C. (MONO-ANA)	
IC1451	NJM4560D	I. C. (MONO-ANA)	
IC1601	AN5265	I. C. (MONO-ANA)	
IC1931	STR-S6707	I. C. (HYBRID)	
IC1932	TLP421F/D4-GR/	PHOTO COUPLER	
IC1971	BA17809T	I. C. (MONO-ANA)	
IC1972-73	LM2940CT-12	I. C. (MONO-ANA)	

Symbol No.	Part No.	Part Name	Description
OTHERS			
CN1003	QGBA001K1-04	B TO B CONNE	
CN1004	QGBA001K1-04	B TO B CONNE	
CN1013	QGF1220C2-19	FFC/FPC CONNECTO	
CP1971	ICP-N10-Y	I. C. PROTECT	
CP1972	ICP-N20-Y	I. C. PROTECT	
CP1973	ICP-N10-Y	I. C. PROTECT	
CP1974	ICP-N20-Y	I. C. PROTECT	
K1931	CE42050-001Z	CORE	
K1972	CE41433-001Z	BEADS CORE	
K1973	CE42050-001Z	CORE	
RY1401	QSK0108-001	RELAY	
TH1901	CEKP002-003	W. P. THERMISTOR	

CRT SOCKET PW BOARD ASS'Y (FX-3062A-H2)

Symbol No.	Part No.	Part Name	Description
RESISTOR			
R3302-04	NRSA63J-101X	MG R	100Ω 1/16W J
R3305	QRZ0111-102	C R	1kΩ 1/2W K
R3306-07	QRL029J-153	OM R	15kΩ 2W J
R3308	QRZ0111-102	C R	1kΩ 1/2W K
R3309-10	QRL029J-153	OM R	15kΩ 2W J
R3311	QRZ0111-102	C R	1kΩ 1/2W K
R3312-13	QRL029J-153	OM R	15kΩ 2W J
R3315	QRZ0107-105Z	C R	1MΩ 1/2W K
R3316	QRZ0111-102	C R	1kΩ 1/2W K
R3317	QRZ0111-474	C R	470kΩ 1/2W K
R3318-20	NRSA63J-101X	MG R	100Ω 1/16W J
R3321	NRSA63J-121X	MG R	120Ω 1/16W J
R3322	NRSA63J-101X	MG R	100Ω 1/16W J
R3323	NRSA63J-680X	MG R	68Ω 1/16W J
R3324	NRSA63J-272X	MG R	2.7kΩ 1/16W J
R3325	NRSA63J-121X	MG R	120Ω 1/16W J
R3326	NRSA63J-101X	MG R	100Ω 1/16W J
R3327	NRSA63J-680X	MG R	68Ω 1/16W J
R3328	NRSA63J-272X	MG R	2.7kΩ 1/16W J
R3329	NRSA63J-121X	MG R	120Ω 1/16W J
R3330	NRSA63J-101X	MG R	100Ω 1/16W J
R3331	NRSA63J-680X	MG R	68Ω 1/16W J
R3332	NRSA63J-272X	MG R	2.7kΩ 1/16W J
R3333-34	NRSA63J-221X	MG R	220Ω 1/16W J
R3337	NRSA63J-101X	MG R	100Ω 1/16W J
R3338-40	NRSA63J-272X	MG R	2.7kΩ 1/16W J

Symbol No.	Part No.	Part Name	Description
CAPACITOR			
C3301	QETN1CM-107Z	E CAP.	100μF 16V M
C3303	NCB21HK-103X	C CAP.	0.01μF 50V K
C3305	QETM2EM-336	E CAP.	33μF 250V M
C3306	QETN2EM-105Z	E CAP.	1μF 250V M
C3307	QCZ0121-102	C CAP.	1000pF 3kV Z
C3308	NDC21HJ-330X	C CAP.	33pF 50V J
C3309	NDC21HJ-271X	C CAP.	270pF 50V J
C3310	NDC21HJ-330X	C CAP.	33pF 50V J
C3311	NDC21HJ-181X	C CAP.	180pF 50V J
C3312	NDC21HJ-330X	C CAP.	33pF 50V J
C3313-16	NDC21HJ-221X	C CAP.	220pF 50V J
C3318	NDC21HJ-330X	C CAP.	33pF 50V J

Symbol No.	Part No.	Part Name	Description
COIL			
L3302	QQL244J-151Z	PEAKING COIL	150μH
L3304	QQL244J-151Z	PEAKING COIL	150μH
L3306	QQL244J-151Z	PEAKING COIL	150μH

Symbol No.	Part No.	Part Name	Description
DIODE			
D3301	RGP10J-5025-T3	SI. DIODE	

Symbol No.	Part No.	Part Name	Description
TRANSISTOR			
Q3301-03	25C4544-LB	SI. TRANSISTOR	
Q3304-07	25C3311A/QR/-T	SI. TRANSISTOR	

Symbol No.	Part No.	Part Name	Description
OTHERS			
SK3001	CE42446-001	C. R. T. SOCKET	

**FRONT CONTROL PW BOARD ASS'Y
(FX-4067A-H2)**

△ Symbol No.	Part No.	Part Name	Description
RESISTOR			
R4801-02	QRE121J-332Y	C R	3.3kΩ 1/2W J
R4803	QRE121J-562Y	C R	5.6kΩ 1/2W J
R4804	QRE121J-332Y	C R	3.3kΩ 1/2W J
R4805	QRE121J-562Y	C R	5.6kΩ 1/2W J
R4806	QRE121J-332Y	C R	3.3kΩ 1/2W J

DIODE			
D4801-04	GL2EG6	L.E.D. (GRN)	

OTHERS			
	CM46978-A01-H	L.E.D. HOLDER	
	QGF1220C2-19	FFC/FPC CONNECTO	
△ CN4014	QGA7901F1-04	W TO B CONNE	
S4801	QSW0619-003Z	PUSH SWITCH	INPUT-A
S4802	QSW0619-003Z	PUSH SWITCH	INPUT-B
S4803	QSW0619-003Z	PUSH SWITCH	UNDER SCAN
S4804	QSW0619-003Z	PUSH SWITCH	UP
S4805	QSW0619-003Z	PUSH SWITCH	DOWN
S4806	QSW0619-003Z	PUSH SWITCH	MENU
S4807	QSW0619-003Z	PUSH SWITCH	CONT
S4808	QSW0619-003Z	PUSH SWITCH	BRIGHT
S4809	QSW0619-003Z	PUSH SWITCH	CHROMA
S4810	QSW0619-003Z	PUSH SWITCH	PHASE
△ S4901	QSP4K21-C01	PUSH SWITCH	POWER SW

INPUT PW BOARD ASS'Y (FX-6071A-H2)

△ Symbol No.	Part No.	Part Name	Description
VARIABLE RESISTOR			
VR6152	QVP0053-202Z	V R(COMB LEVEL)	2kΩ B
VR6159	QVP0053-202Z	V R(COMB PHASE)	2kΩ B
VR6248	QVP0053-202Z	V R(DL AMP)	2kΩ B
VR6260	QVP0053-203Z	V R(SUB COLOR)	20kΩ B
VR6262	QVP0053-103Z	V R(SUB PHASE)	10kΩ B

RESISTOR			
R6001	NRSA63J-151X	MG R	150Ω 1/16W J
R6002	NRSA63J-101X	MG R	100Ω 1/16W J
R6003	NRSA63J-473X	MG R	47kΩ 1/16W J
R6004	NRSA63J-333X	MG R	33kΩ 1/16W J
R6005	NRSA63J-103X	MG R	10kΩ 1/16W J
R6006	NRSA63J-151X	MG R	150Ω 1/16W J
R6007	NRSA63J-101X	MG R	100Ω 1/16W J
R6008	NRSA63J-473X	MG R	47kΩ 1/16W J
R6009	NRSA63J-333X	MG R	33kΩ 1/16W J
R6010	NRSA63J-103X	MG R	10kΩ 1/16W J
R6011-12	NRSA63J-151X	MG R	150Ω 1/16W J
R6013	NRSA63J-101X	MG R	100Ω 1/16W J
R6014	NRSA63J-473X	MG R	47kΩ 1/16W J
R6015	NRSA63J-333X	MG R	33kΩ 1/16W J
R6016	NRSA63J-103X	MG R	10kΩ 1/16W J
R6017	NRSA63J-101X	MG R	100Ω 1/16W J
R6018-21	NRSA63J-151X	MG R	150Ω 1/16W J
R6047	NRSA63J-104X	MG R	100kΩ 1/16W J
R6048-49	NRSA63J-101X	MG R	100Ω 1/16W J
R6060-61	NRSA63J-103X	MG R	10kΩ 1/16W J
R6063	NRSA63J-101X	MG R	100Ω 1/16W J
R6101	NRSA63J-101X	MG R	100Ω 1/16W J
R6102	NRSA63J-332X	MG R	3.3kΩ 1/16W J
R6103	NRSA63J-102X	MG R	1kΩ 1/16W J
R6104	NRSA63J-152X	MG R	1.5kΩ 1/16W J
R6105	NRSA63J-332X	MG R	3.3kΩ 1/16W J
R6107	NRSA63J-102X	MG R	1kΩ 1/16W J
R6108	NRSA63J-391X	MG R	390Ω 1/16W J
R6109	NRSA63J-681X	MG R	680Ω 1/16W J
R6110	NRSA63J-821X	MG R	820Ω 1/16W J
R6112	NRSA63J-222X	MG R	2.2kΩ 1/16W J
R6113	NRSA63J-681X	MG R	680Ω 1/16W J
R6114	NRSA63J-471X	MG R	470Ω 1/16W J
R6115	NRSA63J-330X	MG R	33Ω 1/16W J
R6116	NRSA63J-471X	MG R	470Ω 1/16W J
R6117	NRSA63J-103X	MG R	10kΩ 1/16W J
R6118	NRSA63J-332X	MG R	3.3kΩ 1/16W J
R6119	NRSA63J-223X	MG R	22kΩ 1/16W J
R6120	NRSA63J-183X	MG R	18kΩ 1/16W J
R6121	NRSA63J-472X	MG R	4.7kΩ 1/16W J
R6122	NRSA63J-682X	MG R	6.8kΩ 1/16W J
R6125	NRSA63J-223X	MG R	22kΩ 1/16W J
R6126	NRSA63J-183X	MG R	18kΩ 1/16W J
R6128	NRSA63J-103X	MG R	10kΩ 1/16W J
R6129	NRSA63J-102X	MG R	1kΩ 1/16W J
R6130	NRSA63J-152X	MG R	1.5kΩ 1/16W J
R6131	NRSA63J-222X	MG R	2.2kΩ 1/16W J
R6132	NRSA63J-332X	MG R	3.3kΩ 1/16W J
R6133-34	NRSA63J-561X	MG R	560Ω 1/16W J
R6135	NRSA63J-332X	MG R	3.3kΩ 1/16W J
R6136	NRSA63J-102X	MG R	1kΩ 1/16W J
R6137	NRSA63J-472X	MG R	4.7kΩ 1/16W J
R6138	NRSA63J-101X	MG R	100Ω 1/16W J
R6139	NRSA63J-561X	MG R	560Ω 1/16W J
R6140	NRSA63J-101X	MG R	100Ω 1/16W J
R6141	NRSA63J-332X	MG R	3.3kΩ 1/16W J
R6142	NRSA63J-102X	MG R	1kΩ 1/16W J
R6143	NRSA63J-332X	MG R	3.3kΩ 1/16W J

Symbol No.	Part No.	Part Name	Description
RESISTOR			
R6151	NRSA63J-222X	MG R	2.2kΩ 1/16W J
R6153	NRSA63J-102X	MG R	1kΩ 1/16W J
R6154-55	NRSA63J-103X	MG R	10kΩ 1/16W J
R6156	NRSA63J-153X	MG R	15kΩ 1/16W J
R6157-58	NRSA63J-681X	MG R	680Ω 1/16W J
R6160	NRSA63J-221X	MG R	220Ω 1/16W J
R6161	NRSA63J-105X	MG R	1MΩ 1/16W J
R6162	NRSA63J-222X	MG R	2.2kΩ 1/16W J
R6163	NRSA63J-391X	MG R	390Ω 1/16W J
R6164	NRSA63J-224X	MG R	220kΩ 1/16W J
R6170	NRSA63J-0R0X	MG R	0.0Ω 1/16W J
R6172	NRSA63J-101X	MG R	100Ω 1/16W J
R6173	NRSA63J-682X	MG R	6.8kΩ 1/16W J
R6174	NRSA63J-101X	MG R	100Ω 1/16W J
R6175	NRSA63J-472X	MG R	4.7kΩ 1/16W J
R6176	NRSA63J-222X	MG R	2.2kΩ 1/16W J
R6177	NRSA63J-102X	MG R	1kΩ 1/16W J
R6178	NRSA63J-101X	MG R	100Ω 1/16W J
R6179	NRSA63J-102X	MG R	1kΩ 1/16W J
R6201	NRSA63J-101X	MG R	100Ω 1/16W J
R6202	NRSA63J-332X	MG R	3.3kΩ 1/16W J
R6203	NRSA63J-102X	MG R	1kΩ 1/16W J
R6204	NRSA63J-152X	MG R	1.5kΩ 1/16W J
R6205	NRSA63J-103X	MG R	10kΩ 1/16W J
R6206	NRSA63J-472X	MG R	4.7kΩ 1/16W J
R6207	NRSA63J-222X	MG R	2.2kΩ 1/16W J
R6208	NRSA63J-333X	MG R	33kΩ 1/16W J
R6209	NRSA63J-103X	MG R	10kΩ 1/16W J
R6210	NRSA63J-101X	MG R	100Ω 1/16W J
R6211	NRSA63J-332X	MG R	3.3kΩ 1/16W J
R6212	NRSA63J-102X	MG R	1kΩ 1/16W J
R6213	NRSA63J-681X	MG R	680Ω 1/16W J
R6214	NRSA63J-103X	MG R	10kΩ 1/16W J
R6215	NRSA63J-472X	MG R	4.7kΩ 1/16W J
R6216	NRSA63J-222X	MG R	2.2kΩ 1/16W J
R6217	NRSA63J-152X	MG R	1.5kΩ 1/16W J
R6220	NRSA63J-101X	MG R	100Ω 1/16W J
R6221	NRSA63J-103X	MG R	10kΩ 1/16W J
R6222	NRSA63J-333X	MG R	33kΩ 1/16W J
R6223	NRSA63J-103X	MG R	10kΩ 1/16W J
R6224	NRSA63J-333X	MG R	33kΩ 1/16W J
R6225	NRSA63J-103X	MG R	10kΩ 1/16W J
R6226	NRSA63J-472X	MG R	4.7kΩ 1/16W J
R6227	NRSA63J-102X	MG R	1kΩ 1/16W J
R6228	NRSA63J-682X	MG R	6.8kΩ 1/16W J
R6229	NRSA63J-101X	MG R	100Ω 1/16W J
R6232-33	NRSA63J-152X	MG R	1.5kΩ 1/16W J
R6234	NRSA63J-103X	MG R	10kΩ 1/16W J
R6241	NRSA63J-101X	MG R	100Ω 1/16W J
R6242	NRSA63J-222X	MG R	2.2kΩ 1/16W J
R6243	NRSA63J-682X	MG R	6.8kΩ 1/16W J
R6245	NRSA63J-222X	MG R	2.2kΩ 1/16W J
R6246	NRSA63J-101X	MG R	100Ω 1/16W J
R6247	NRSA63J-822X	MG R	8.2kΩ 1/16W J
R6249	NRSA63J-471X	MG R	470Ω 1/16W J
R6250-51	NRSA63J-391X	MG R	390Ω 1/16W J
R6252	NRSA63J-224X	MG R	220kΩ 1/16W J
R6253	NRSA63J-103X	MG R	10kΩ 1/16W J
R6254	NRSA63J-223X	MG R	22kΩ 1/16W J
R6255	NRSA63J-684X	MG R	680kΩ 1/16W J
R6256	NRSA63J-101X	MG R	100Ω 1/16W J
R6257	NRSA63J-222X	MG R	2.2kΩ 1/16W J
R6258	NRSA63J-681X	MG R	680Ω 1/16W J
R6259	NRSA63J-103X	MG R	10kΩ 1/16W J
R6261	NRSA63J-0R0X	MG R	0.0Ω 1/16W J
R6263	NRSA63J-0R0X	MG R	0.0Ω 1/16W J
R6266-67	NRSA63J-473X	MG R	47kΩ 1/16W J
R6268	NRSA63J-682X	MG R	6.8kΩ 1/16W J

Symbol No.	Part No.	Part Name	Description
RESISTOR			
R6269	NRSA63J-332X	MG R	3.3kΩ 1/16W J
R6270-71	NRSA63J-103X	MG R	10kΩ 1/16W J
R6272	NRSA63J-0R0X	MG R	0.0Ω 1/16W J
R6274	NRSA63J-472X	MG R	4.7kΩ 1/16W J
R6277	NRSA63J-225X	MG R	2.2MΩ 1/16W J
R6401	NRSA63J-153X	MG R	15kΩ 1/16W J
R6402	NRSA63J-103X	MG R	10kΩ 1/16W J
R6403-04	NRSA63J-102X	MG R	1kΩ 1/16W J
R6405	NRSA63J-103X	MG R	10kΩ 1/16W J
R6406	NRSA63J-472X	MG R	4.7kΩ 1/16W J
R6407	NRSA63J-222X	MG R	2.2kΩ 1/16W J
R6408	NRSA63J-182X	MG R	1.8kΩ 1/16W J
R6531	NRSA63J-103X	MG R	10kΩ 1/16W J
R6532	NRSA63J-101X	MG R	100Ω 1/16W J
R6533-34	NRSA63J-563X	MG R	56kΩ 1/16W J
R6535	NRSA63J-333X	MG R	33kΩ 1/16W J
R6536	NRSA63J-101X	MG R	100Ω 1/16W J
R6537	NRSA63J-103X	MG R	10kΩ 1/16W J
R6538	NRSA63J-272X	MG R	2.7kΩ 1/16W J
R6539	NRSA63J-391X	MG R	390Ω 1/16W J
R6540-41	NRSA63J-101X	MG R	100Ω 1/16W J
R6542	NRSA63J-103X	MG R	10kΩ 1/16W J
R6543	NRSA63J-472X	MG R	4.7kΩ 1/16W J
R6544	NRSA63J-103X	MG R	10kΩ 1/16W J
R6545	NRSA63J-472X	MG R	4.7kΩ 1/16W J
R6546	NRSA63J-331X	MG R	330Ω 1/16W J
R6547	NRSA63J-103X	MG R	10kΩ 1/16W J
R6548	NRSA63J-102X	MG R	1kΩ 1/16W J
R6549	NRSA63J-271X	MG R	270Ω 1/16W J
R6550	NRSA63J-101X	MG R	100Ω 1/16W J
R6553	NRSA63J-472X	MG R	4.7kΩ 1/16W J
R6555	NRSA63J-332X	MG R	3.3kΩ 1/16W J
R6556-58	NRSA63J-472X	MG R	4.7kΩ 1/16W J
R6559-60	NRSA63J-101X	MG R	100Ω 1/16W J
R6561	NRSA63J-681X	MG R	680Ω 1/16W J
R6562	NRSA63J-391X	MG R	390Ω 1/16W J
R6563-68	NRSA63J-101X	MG R	100Ω 1/16W J
R6569	NRSA63J-103X	MG R	10kΩ 1/16W J
R6570	NRSA63J-102X	MG R	1kΩ 1/16W J
R6571	NRSA63J-682X	MG R	6.8kΩ 1/16W J
R6572	NRSA63J-103X	MG R	10kΩ 1/16W J
R6573	NRSA63J-102X	MG R	1kΩ 1/16W J
R6574	NRSA63J-271X	MG R	270Ω 1/16W J
R6575	NRSA63J-103X	MG R	10kΩ 1/16W J
R6577	NRSA63J-472X	MG R	4.7kΩ 1/16W J
R6578	NRSA63J-224X	MG R	220kΩ 1/16W J
R6601	NRSA63J-101X	MG R	100Ω 1/16W J
R6602	NRSA63J-472X	MG R	4.7kΩ 1/16W J
R6603	NRSA63J-122X	MG R	1.2kΩ 1/16W J
R6604-06	NRSA63J-222X	MG R	2.2kΩ 1/16W J
R6607	NRSA63J-102X	MG R	1kΩ 1/16W J
R6608	NRSA63J-332X	MG R	3.3kΩ 1/16W J
R6609	NRSA63J-101X	MG R	100Ω 1/16W J
R6610	NRSA63J-472X	MG R	4.7kΩ 1/16W J
R6611	NRSA63J-102X	MG R	1kΩ 1/16W J
R6612-13	NRSA63J-222X	MG R	2.2kΩ 1/16W J
R6614	NRSA63J-332X	MG R	3.3kΩ 1/16W J
R6615	NRSA63J-102X	MG R	1kΩ 1/16W J
R6616	NRSA63J-332X	MG R	3.3kΩ 1/16W J
R6628	NRSA63J-103X	MG R	10kΩ 1/16W J
R6629	NRSA63J-101X	MG R	100Ω 1/16W J
R6630	NRSA63J-222X	MG R	2.2kΩ 1/16W J
R6631	NRSA63J-182X	MG R	1.8kΩ 1/16W J
R6632	NRSA63J-103X	MG R	10kΩ 1/16W J
R6633-34	NRSA63J-102X	MG R	1kΩ 1/16W J
R6676-77	NRSA63J-221X	MG R	220Ω 1/16W J
R6678	NRSA63J-102X	MG R	1kΩ 1/16W J
R6679	NRSA63J-223X	MG R	22kΩ 1/16W J

Symbol No.	Part No.	Part Name	Description
RESISTOR			
R6680	NRSA63J-102X	MG R	1kΩ 1/16W J
R6681	NRSA63J-223X	MG R	22kΩ 1/16W J
R6682-84	NRSA63J-101X	MG R	100Ω 1/16W J
R6685-86	NRSA63J-225X	MG R	2.2MΩ 1/16W J
R6689	NRSA63J-101X	MG R	100Ω 1/16W J
R6701-02	NRSA63J-103X	MG R	10kΩ 1/16W J
R6705-06	NRSA63J-103X	MG R	10kΩ 1/16W J
R6707-08	NRSA63J-681X	MG R	680Ω 1/16W J
R6711-12	NRSA63J-681X	MG R	680Ω 1/16W J
R6713-16	NRSA63J-103X	MG R	10kΩ 1/16W J
R6717-19	NRSA63J-472X	MG R	4.7kΩ 1/16W J
R6720-21	NRSA63J-103X	MG R	10kΩ 1/16W J
R6722	NRSA63J-472X	MG R	4.7kΩ 1/16W J
R6723	NRSA63J-103X	MG R	10kΩ 1/16W J
R6724-25	NRSA63J-101X	MG R	100Ω 1/16W J
R6726-27	NRSA63J-682X	MG R	6.8kΩ 1/16W J
R6728-29	NRSA63J-472X	MG R	4.7kΩ 1/16W J
R6730	NRSA63J-103X	MG R	10kΩ 1/16W J
R6731-32	NRSA63J-102X	MG R	1kΩ 1/16W J
R6733	NRSA63J-103X	MG R	10kΩ 1/16W J
R6734-37	NRSA63J-102X	MG R	1kΩ 1/16W J
R6739-40	NRSA63J-103X	MG R	10kΩ 1/16W J
R6741	NRSA63J-101X	MG R	100Ω 1/16W J
R6742	NRSA63J-103X	MG R	10kΩ 1/16W J
R6744-45	NRSA63J-103X	MG R	10kΩ 1/16W J
R6746	NRSA63J-101X	MG R	100Ω 1/16W J
R6747	NRSA63J-103X	MG R	10kΩ 1/16W J
R6749	NRSA63J-103X	MG R	10kΩ 1/16W J
R6750	NRSA63J-472X	MG R	4.7kΩ 1/16W J
R6751	NRSA63J-103X	MG R	10kΩ 1/16W J
R6755-62	NRSA63J-101X	MG R	100Ω 1/16W J
R6763-66	NRSA63J-221X	MG R	220Ω 1/16W J
R6801	NRSA63J-101X	MG R	100Ω 1/16W J
R6802	NRSA63J-472X	MG R	4.7kΩ 1/16W J
R6803	NRSA63J-101X	MG R	100Ω 1/16W J
R6804	NRSA63J-472X	MG R	4.7kΩ 1/16W J
R6805	NRSA63J-102X	MG R	1kΩ 1/16W J
R6806-07	NRSA63J-222X	MG R	2.2kΩ 1/16W J
R6808	NRSA63J-153X	MG R	15kΩ 1/16W J
R6809	NRSA63J-332X	MG R	3.3kΩ 1/16W J
R6810	NRSA63J-102X	MG R	1kΩ 1/16W J
R6811	NRSA63J-223X	MG R	22kΩ 1/16W J
R6812	NRVA02D-102X	MF R	1kΩ 1/10W D
R6814	NRVA02D-682X	MF R	6.8kΩ 1/10W D
R6815	NRSA63J-104X	MG R	100kΩ 1/16W J
R6816	NRSA63J-222X	MG R	2.2kΩ 1/16W J
R6817	NRSA63J-332X	MG R	3.3kΩ 1/16W J
R6818-19	NRSA63J-102X	MG R	1kΩ 1/16W J
R6820	NRVA02D-102X	MF R	1kΩ 1/10W D
R6822	NRVA02D-472X	MF R	4.7kΩ 1/10W D
R6824	NRSA63J-472X	MG R	4.7kΩ 1/16W J
R6825	NRSA63J-153X	MG R	15kΩ 1/16W J
R6826	NRSA63J-102X	MG R	1kΩ 1/16W J
R6827	NRSA63J-103X	MG R	10kΩ 1/16W J
R6828	NRVA02D-152X	MF R	1.5kΩ 1/10W D
R6830	NRVA02D-152X	MF R	1.5kΩ 1/10W D
R6832	NRSA63J-222X	MG R	2.2kΩ 1/16W J
R6833	NRSA63J-152X	MG R	1.5kΩ 1/16W J
R6834	NRSA63J-102X	MG R	1kΩ 1/16W J
R6835	NRSA63J-681X	MG R	680Ω 1/16W J
R6836	NRSA63J-222X	MG R	2.2kΩ 1/16W J
R6837	NRSA63J-102X	MG R	1kΩ 1/16W J
R6861-62	NRSA63J-102X	MG R	1kΩ 1/16W J
R6863	NRSA63J-682X	MG R	6.8kΩ 1/16W J
R6864-65	NRSA63J-102X	MG R	1kΩ 1/16W J
R6866	NRSA63J-682X	MG R	6.8kΩ 1/16W J

Symbol No.	Part No.	Part Name	Description
CAPACITOR			
C6001	QETN1HM-475Z	E CAP.	4.7μF 50V M
C6002	NCF21HZ-104X	C CAP.	0.1μF 50V Z
C6003	QETN1HM-475Z	E CAP.	4.7μF 50V M
C6004	NCF21HZ-104X	C CAP.	0.1μF 50V Z
C6005	QETN1HM-475Z	E CAP.	4.7μF 50V M
C6006	NCF21HZ-104X	C CAP.	0.1μF 50V Z
C6007	NCB21HK-103X	C CAP.	0.01μF 50V K
C6018-19	NCB21CK-474X	C CAP.	0.47μF 16V K
C6020-27	NCB21HK-103X	C CAP.	0.01μF 50V K
C6028	NCB21CK-474X	C CAP.	0.47μF 16V K
C6029	NCB21HK-103X	C CAP.	0.01μF 50V K
C6030	QETN1HM-226Z	E CAP.	22μF 50V M
C6031	NCB21CK-474X	C CAP.	0.47μF 16V K
C6032	NCB21EK-104X	C CAP.	0.1μF 25V K
C6033	NCF21HZ-104X	C CAP.	0.1μF 50V Z
C6034	QETN1CM-107Z	E CAP.	100μF 16V M
C6035	NCF21HZ-104X	C CAP.	0.1μF 50V Z
C6036	QETN1CM-107Z	E CAP.	100μF 16V M
C6060-61	QETN1HM-225Z	E CAP.	2.2μF 50V M
C6063-64	NDC21HJ-151X	C CAP.	150pF 50V J
C6065	NCB21HK-103X	C CAP.	0.01μF 50V K
C6101	QETN1EH-476Z	E CAP.	47μF 25V M
C6102	NDC21HJ-330X	C CAP.	33pF 50V J
C6104	QENC1CM-226Z	BP E CAP.	22μF 16V M
C6109	NCF21HZ-104X	C CAP.	0.1μF 50V Z
C6110	QETN1CM-107Z	E CAP.	100μF 16V M
C6151	NCB21HK-103X	C CAP.	0.01μF 50V K
C6152	NDC21HJ-560X	C CAP.	56pF 50V J
C6153	NCB21HK-103X	C CAP.	0.01μF 50V K
C6154	NDC21HJ-180X	C CAP.	18pF 50V J
C6155	QENC1HM-105Z	BP E CAP.	1μF 50V M
C6156	QETN1CM-107Z	E CAP.	100μF 16V M
C6157	NCF21HZ-104X	C CAP.	0.1μF 50V Z
C6160	NCB21EK-104X	C CAP.	0.1μF 25V K
C6201	NCB21EK-104X	C CAP.	0.1μF 25V K
C6203	NCB21EK-104X	C CAP.	0.1μF 25V K
C6204	NCF21HZ-104X	C CAP.	0.1μF 50V Z
C6205-06	NCB21EK-104X	C CAP.	0.1μF 25V K
C6208	NCF21HZ-104X	C CAP.	0.1μF 50V Z
C6209	NDC21HJ-8R0X	C CAP.	8.0pF 50V J
C6210	NCF21HZ-104X	C CAP.	0.1μF 50V Z
C6211	QETN1CM-107Z	E CAP.	100μF 16V M
C6212	NCF21HZ-104X	C CAP.	0.1μF 50V Z
C6213	QETN1CM-107Z	E CAP.	100μF 16V M
C6241-42	NCB21HK-103X	C CAP.	0.01μF 50V K
C6243	NDC21HJ-680X	C CAP.	68pF 50V J
C6245	NDC21HJ-151X	C CAP.	150pF 50V J
C6246-47	NDC21HJ-221X	C CAP.	220pF 50V J
C6248	NCB21HK-273X	C CAP.	0.027μF 50V K
C6249	QETN1HM-474Z	E CAP.	0.47μF 50V M
C6250	QETN1CM-107Z	E CAP.	100μF 16V M
C6251	NCF21HZ-104X	C CAP.	0.1μF 50V Z
C6252	NCB21HK-103X	C CAP.	0.01μF 50V K
C6253	QENC1EM-106Z	BP E CAP.	10μF 25V M
C6254	NCB21EK-104X	C CAP.	0.1μF 25V K
C6255	NDC21HJ-100X	C CAP.	10pF 50V J
C6257	NDC21HJ-100X	C CAP.	10pF 50V J
C6259	NDC21HJ-470X	C CAP.	47pF 50V J
C6260	NDC21HJ-101X	C CAP.	100pF 50V J
C6264-65	NCF21HZ-104X	C CAP.	0.1μF 50V Z
C6401	NDC21HJ-101X	C CAP.	100pF 50V J
C6402	NCB21HK-103X	C CAP.	0.01μF 50V K
C6403	QETN1EM-476Z	E CAP.	47μF 25V M
C6404	QENC1CM-226Z	BP E CAP.	22μF 16V M
C6506	QFV71HJ-224Z	MF CAP.	0.22μF 50V J
C6507	NCB21HK-222X	C CAP.	2200pF 50V K
C6508	NCB21EK-104X	C CAP.	0.1μF 25V K
C6509	NCB21CK-474X	C CAP.	0.47μF 16V K
C6510	QETN1HM-225Z	E CAP.	2.2μF 50V M
C6511	NCB21HK-223X	C CAP.	0.022μF 50V K

Symbol No.	Part No.	Part Name	Description
CAPACITOR			
C6512	QETN1HM-106Z	E CAP.	10µF 50V M
C6513	QETN1CM-107Z	E CAP.	100µF 16V M
C6514	NCF21HZ-104X	C CAP.	0.1µF 50V Z
C6515-22	NCB21EK-104X	C CAP.	0.1µF 25V K
C6523	QETN1CM-107Z	E CAP.	100µF 16V M
C6524	NCF21HZ-104X	C CAP.	0.1µF 50V Z
C6525	QETN1CM-107Z	E CAP.	100µF 16V M
C6526	NCF21HZ-104X	C CAP.	0.1µF 50V Z
C6527	QETN1HM-225Z	E CAP.	2.2µF 50V M
C6528-30	NCB21EK-104X	C CAP.	0.1µF 25V K
C6531	NCB21CK-474X	C CAP.	0.47µF 16V K
C6532	QETN1HM-225Z	E CAP.	2.2µF 50V M
C6533	NCB21EK-104X	C CAP.	0.1µF 25V K
C6534	QETN1HM-475Z	E CAP.	4.7µF 50V M
C6535	QETN1CM-107Z	E CAP.	100µF 16V M
C6536	NCF21HZ-104X	C CAP.	0.1µF 50V Z
C6537-38	NDC21HJ-120X	C CAP.	12pF 50V J
C6539	NCF21HZ-104X	C CAP.	0.1µF 50V Z
C6540	QETN1HM-105Z	E CAP.	1µF 50V M
C6541-42	QETN1EM-476Z	E CAP.	47µF 25V M
C6601	NDC21HJ-390X	C CAP.	39pF 50V J
C6602	NDC21HJ-8R0X	C CAP.	8.0pF 50V J
C6603	NDC21HJ-181X	C CAP.	180pF 50V J
C6604	NDC21HJ-390X	C CAP.	39pF 50V J
C6605	NDC21HJ-8R0X	C CAP.	8.0pF 50V J
C6606	NDC21HJ-181X	C CAP.	180pF 50V J
C6607-08	NCB21EK-104X	C CAP.	0.1µF 25V K
C6609	QETN1CM-107Z	E CAP.	100µF 16V M
C6610	NCF21HZ-104X	C CAP.	0.1µF 50V Z
C6611-12	NCB21EK-104X	C CAP.	0.1µF 25V K
C6613	QETN1HM-106Z	E CAP.	10µF 50V M
C6614-15	NCB21EK-104X	C CAP.	0.1µF 25V K
C6616	QENC1HM-474Z	BP E CAP.	0.47µF 50V M
C6617	QETN1CM-107Z	E CAP.	100µF 16V M
C6618	NCF21HZ-104X	C CAP.	0.1µF 50V Z
C6619	QENC1HM-474Z	BP E CAP.	0.47µF 50V M
C6620-22	QETN1HM-105Z	E CAP.	1µF 50V M
C6623-27	NCB21EK-104X	C CAP.	0.1µF 25V K
C6636-37	NDC21HJ-101X	C CAP.	100pF 50V J
C6701	QENC1EM-106Z	BP E CAP.	10µF 25V M
C6702	NDC21HJ-560X	C CAP.	56pF 50V J
C6703	NDC21HJ-680X	C CAP.	68pF 50V J
C6704	QETN1CM-107Z	E CAP.	100µF 16V M
C6705	NCF21HZ-104X	C CAP.	0.1µF 50V Z
C6706	QETN1CM-227Z	E CAP.	220µF 16V M
C6707-08	NCF21HZ-104X	C CAP.	0.1µF 50V Z
C6709	QETN1EM-227Z	E CAP.	220µF 25V M
C6710	QETN1HM-225Z	E CAP.	2.2µF 50V M
C6801	NDC21HJ-681X	C CAP.	680pF 50V J
C6802	NDC21HJ-102X	C CAP.	1000pF 50V J
C6803	NDC21HJ-681X	C CAP.	680pF 50V J
C6804	NDC21HJ-102X	C CAP.	1000pF 50V J
C6805	NCF21HZ-104X	C CAP.	0.1µF 50V Z
C6806	QETN1CM-107Z	E CAP.	100µF 16V M
C6807	NCF21HZ-104X	C CAP.	0.1µF 50V Z
C6808	QETN1CM-107Z	E CAP.	100µF 16V M
C6809	NDC21HJ-331X	C CAP.	330pF 50V J
C6810	NDC21HJ-102X	C CAP.	1000pF 50V J
C6861-62	NDC21HJ-101X	C CAP.	100pF 50V J
C6901	NCF21HZ-104X	C CAP.	0.1µF 50V Z
C6902-03	QETN1CM-107Z	E CAP.	100µF 16V M
C6904-05	NCF21HZ-104X	C CAP.	0.1µF 50V Z
C6906	QETN1CM-107Z	E CAP.	100µF 16V M
C6909	NCF21HZ-104X	C CAP.	0.1µF 50V Z
C6910-11	QETN1CM-107Z	E CAP.	100µF 16V M
C6912	NCF21HZ-104X	C CAP.	0.1µF 50V Z

Symbol No.	Part No.	Part Name	Description
TRANSFORMER			
T6241	QQR1018-001	I. F. TRANSFORMER	
COIL			
L6101	QQL244K-220Z	PEAKING COIL	22µH
L6151	QQL244K-5R6Z	PEAKING COIL	5.6µH
L6152	QQL244K-270Z	PEAKING COIL	27µH
L6241	QQL244K-8R2Z	PEAKING COIL	8.2µH
L6601-02	QQL244K-820Z	PEAKING COIL	82µH
L6701	QQL244K-4R7Z	PEAKING COIL	4.7µH
L6702	QQL244K-8R2Z	PEAKING COIL	8.2µH
DIODE			
D6001-06	MA111-X	SI. DIODE	
D6007	MA3091/M/-X	ZENER DIODE	
D6101	MA111-X	SI. DIODE	
D6401-02	MA111-X	SI. DIODE	
D6501-10	MA111-X	SI. DIODE	
D6511	MA3068/M/-X	ZENER DIODE	
D6514-18	MA111-X	SI. DIODE	
D6702-04	MA111-X	SI. DIODE	
D6705-07	MA3051/M/-X	ZENER DIODE	
D6708	MA111-X	SI. DIODE	
D6709	MA3120/M/-X	ZENER DIODE	
D6710-11	MA111-X	SI. DIODE	
D6801-04	MA111-X	SI. DIODE	
D6861-64	MA111-X	SI. DIODE	
TRANSISTOR			
Q6001-03	2SC2412K/QR/-X	SI. TRANSISTOR	
Q6101-05	2SC2412K/QR/-X	SI. TRANSISTOR	
Q6106	DTC124EKA-X	DIGI. TRANSISTOR	
Q6109	DTC124EKA-X	DIGI. TRANSISTOR	
Q6110-11	2SC2412K/QR/-X	SI. TRANSISTOR	
Q6112	2SA1037AK/QR/-X	SI. TRANSISTOR	
Q6113-15	2SC2412K/QR/-X	SI. TRANSISTOR	
Q6151-53	2SC2412K/QR/-X	SI. TRANSISTOR	
Q6154	2SA1037AK/QR/-X	SI. TRANSISTOR	
Q6155	2SC2412K/QR/-X	SI. TRANSISTOR	
Q6156	DTC124EKA-X	DIGI. TRANSISTOR	
Q6158-60	2SC2412K/QR/-X	SI. TRANSISTOR	
Q6201-04	2SC2412K/QR/-X	SI. TRANSISTOR	
Q6206-08	2SC2412K/QR/-X	SI. TRANSISTOR	
Q6210	2SC2412K/QR/-X	SI. TRANSISTOR	
Q6211	2SA1037AK/QR/-X	SI. TRANSISTOR	
Q6241-43	2SC2412K/QR/-X	SI. TRANSISTOR	
Q6244	DTC124EKA-X	DIGI. TRANSISTOR	
Q6401	2SC2412K/QR/-X	SI. TRANSISTOR	
Q6402	2SA965/OY/-T	SI. TRANSISTOR	
Q6512-15	2SC2412K/QR/-X	SI. TRANSISTOR	
Q6516	DTC124EKA-X	DIGI. TRANSISTOR	
Q6518-20	2SA1037AK/QR/-X	SI. TRANSISTOR	
Q6522	2SA1037AK/QR/-X	SI. TRANSISTOR	
Q6523	2SC2412K/QR/-X	SI. TRANSISTOR	
Q6524	2SA1037AK/QR/-X	SI. TRANSISTOR	
Q6601-08	2SC2412K/QR/-X	SI. TRANSISTOR	
Q6609	DTC124EKA-X	DIGI. TRANSISTOR	
Q6623-24	2SA1037AK/QR/-X	SI. TRANSISTOR	
Q6701-02	DTA124EKA-X	DIGI. TRANSISTOR	
Q6705-06	DTA124EKA-X	DIGI. TRANSISTOR	
Q6707	DTC124EKA-X	DIGI. TRANSISTOR	
Q6708	2SC2412K/QR/-X	SI. TRANSISTOR	
Q6710	DTC124EKA-X	DIGI. TRANSISTOR	
Q6712	2SC2412K/QR/-X	SI. TRANSISTOR	
Q6801-03	2SC2412K/QR/-X	SI. TRANSISTOR	

△ Symbol No. Part No. Part Name Description

TRANSISTOR

Q6804 2SA1037AK/QR/-X SI. TRANSISTOR
 Q6805-11 2SC2412K/QR/-X SI. TRANSISTOR
 Q6861-62 2SA1037AK/QR/-X SI. TRANSISTOR

IC

IC6001 MM1311BD I. C (MONO-ANA)
 IC6002 TC4053BF/N/-XE I. C (DIGI-MOS)
 IC6241 AN5625N I. C (MONO-ANA)
 IC6502 TA1276AN I. C (MONO-ANA)
 IC6601 TA8772AN I. C (MONO-ANA)
 IC6701 M37212M8-0615P I. C (MICRO COMP.)
 IC6702 AT24C08-H140PN I. C (EP-ROM)
 IC6703 L78LR05E-MA I. C (MONO-ANA)
 IC6801-03 TC4538BF/N/-XE I. C (DIGI-MOS)
 IC6901 BA17809T I. C (MONO-ANA)
 IC6903 BA17805T I. C (MONO-ANA)

OTHERS

△ CP6901 ICP-N10-Y I. C. PROTECT
 △ CP6903 ICP-N10-Y I. C. PROTECT
 DL6101 CE42106-001J1 DELAY LINE
 DL6241 CE41489-001 DELAY LINE (1H)
 FL6201 CE41301-001J1 BANDPASS FILTER
 FL6202 CELT034-002 B. PASS TRANSF.
 J6001-02 CEMB021-002 BNC CONNECTOR
 J6003-04 QMD2B04-001 MINI CONNECTOR
 J6005 CEMN036-005 PIN JACK
 J6006 CEMN079-002 PIN JACK
 MD6151 QAX0581-001 COMB FILTER
 S6241 QSS1A22-C04 SLIDE SWITCH
 TC6103 QAT7003-450 TRIM. CAP. APC SW
 TC6256 QAT7003-450 TRIM. CAP. 45pF 100V
 TC6258 QAT7003-450 TRIM. CAP. 45pF 100V
 X6241 CE40749-001Z CRYSTAL
 X6242 CE40668-001Z CRYSTAL
 X6501 CE40749-001Z CRYSTAL
 X6502 CE40668-001Z CRYSTAL
 X6503 CSB503F30-T2 CER. RESONATOR
 X6701 CST8.00MTW CER. RESONATOR

LINE FILTER PW BOARD ASS'Y (FX-9078A-H2)

△ Symbol No. Part No. Part Name Description

CAPACITOR

△ C9901 QFZ9036-104 MF CAP. 0.1μFAC250V M
 △ C9902 QFZ9036-104 MF CAP. 0.1μFAC250V M
 △ C9903 QFZ9036-104 MF CAP. 0.1μFAC250V M

OTHERS

CM48239-001-H INLET BKT
 CEM6002-001Z FUSE CLIP
 △ CN9003 QGBA001J1-04 B TO B CONNE
 △ CN9004 QGBA001J1-04 B TO B CONNE
 △ CN9014 QGA7901C1-04 W TO B CONNE
 △ F9901 QMF51D2-4R0J1 FUSE
 △ J9901 QMCB006-C01 AC INLET
 △ LF9901 CELF001-001J1 LINE FILTER
 △ LF9902 CELF010-001J6 LINE FILTER

PACKING

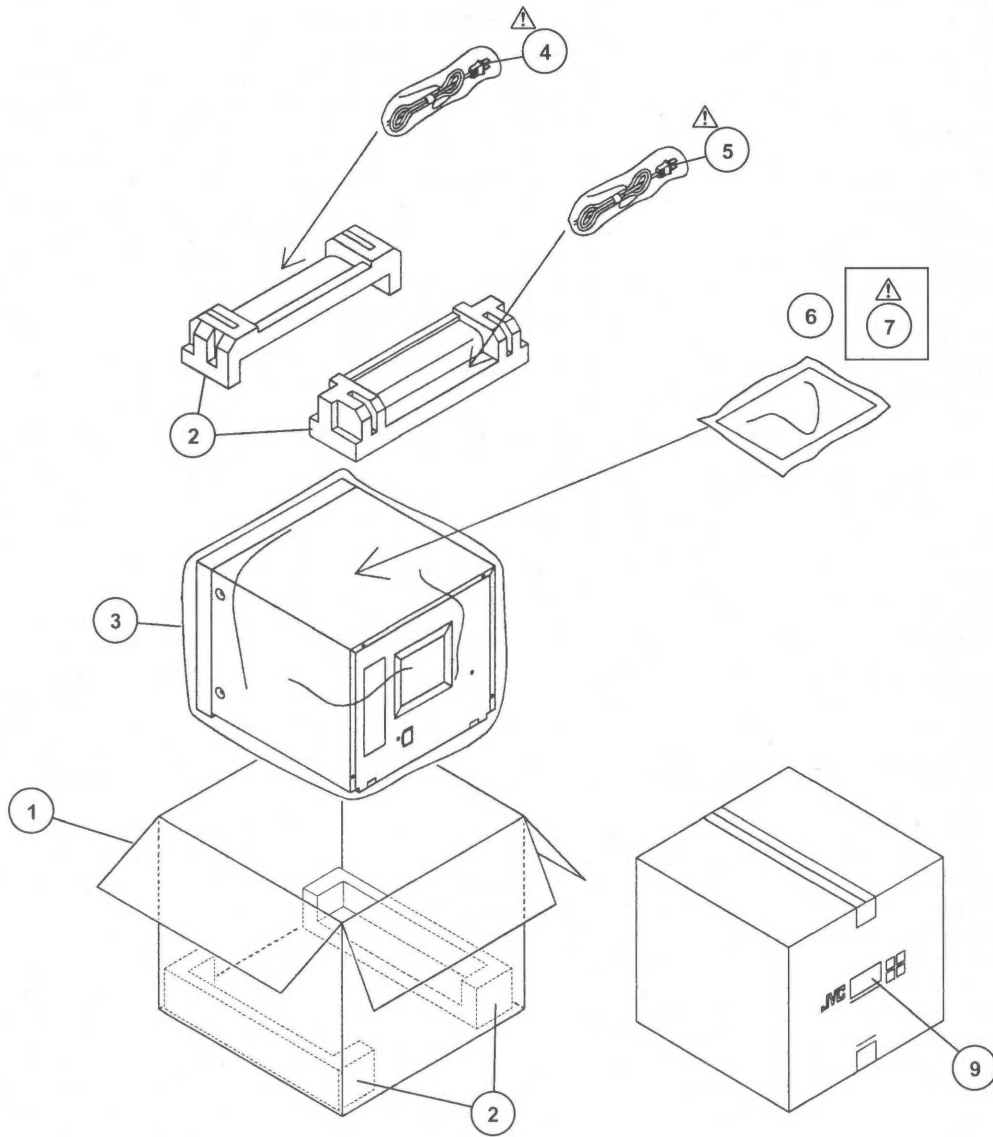

PACKING PARTS LIST

△ Ref.No.	Part No.	Part Name	Description
1	LC10845-011A-H	PACKING CASE	4pcs in 1set
2	LC10301-003A-H	CUSHION ASSY	
3	CP30967-002-H	POLY BAG	
△ 4	QMPP010-200-JC	POWER CORD	
△ 5	QMPL040-200-JC	POWER CORD	
6	CP30966-001-H	POLY BAG	
△ 7	LCT0882-001A-H	INST BOOK	
9	CM47385-00B-H	POS/SERIAL LABEL	

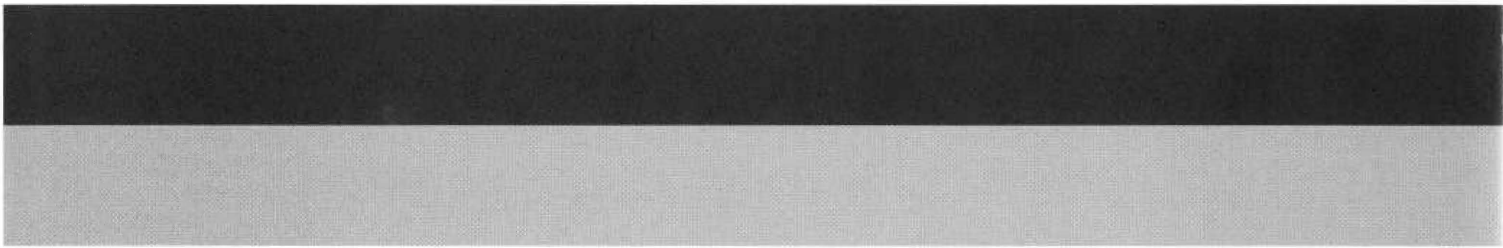

JVC

VICTOR COMPANY OF JAPAN, LIMITED
PROJECTION & SYSTEM NETWORK BUSINESS UNIT 1106 Heta, Iwai-city, Ibaraki-prefecture, 306-0698, Japan

TMH140PN-H #4



Printed in Japan
VP 0011
DP5050