



TASCAM BD-01U

CONTROL I/O connector

RS-232C/ETHERNET Protocol Specification

Ver. 1.01

July 2016

TEAC Corporation

Warning

TEAC Corporation (hereinafter, “the Company”), with the prerequisite that the customer agrees to the conditions in the following Protocol Use Agreement, permits the customer to use the protocol described in this specification document.

If the customer does not agree to the conditions in this Protocol Use Agreement, the customer may not use this protocol and must return this specification document. Moreover, the customer must acknowledge that if they violate a condition of the following Protocol Use Agreement, the customer will infringe on the rights of the Company and will be required to cease further use and be subject to claims for damages, for example.

Protocol Use Agreement

1. This agreement becomes effective as soon as the customer starts using this protocol.
2. The Company grants the customer nonexclusive, nontransferable rights of use in order to develop devices (including software) that have compatibility with the covered TASCAM products.
3. The acquisition of this specification document by the customer does not indicate the granting of any rights, authorizations or other privileges in relation to this protocol other than those specified in this Protocol Use Agreement. The customer must recognize that these specifications, as a written work belonging to the Company, are protected in accordance with the copyright laws of nations that are signatory members of the “Universal Copyright Convention” and the “Berne Convention for the Protection of Literary and Artistic Works”. Without exception, the intellectual property related to this protocol belongs to the Company or a source that has provided it to the Company.
4.
 - (1) The customer may not reproduce this specification document.
 - (2) The customer may not transfer this specification document to a third party without previous consent of the Company.
 - (3) Since confidential information that belongs to the Company is contained in this specification document, the customer may not disclose its contents to a third party without the previous consent of the Company.
5. This specification document and this protocol are provided as is. The Company does not provide any kind of guarantee that this protocol and the contents of this specification document are suitable for the specific use objectives of the customer or that they are free of errors.
6. The Company cannot respond to customer inquiries regarding the contents of this document
7. The Company bears no responsibility for any damage (such as business loss, interruption of business operation, loss of business data or other financial damage) that results from the use of or inability to use this specification document and this protocol. This condition applies equally even if the Company is informed of the possibility of such damage in advance.

1. Overview

The CONTROL I/O connector (RS-232C or ETHERNET) on the BD-01U enables you to control the BD-01U from a computer or other external device. In this document, the BD-01U is referred to as the “controlled device”, and the external device that controls it is referred to as the “external controller.”

2. RS-232C Hardware Specifications

Electrical specifications

Standard	Conforms to JIS X-5101 (equivalent to former JIS C-6361 and EIA RS-232C) (Not compatible with the RS-422A used in professional VTR units)
Impedance at receiver	When measured with an applied voltage of between ± 3 and 15V, the DC resistance is between $3K\Omega$ and $7K\Omega$. Total load capacitance is 2500pF or below.
Open circuit voltage at transmitter	25V or below
Open circuit voltage at receiver	2V or below
Signal voltage	When the open circuit voltage at the receiver is 0V, the signal voltage is between $\pm 5V$ and $\pm 15V$ for a load impedance of between $3K$ and $7K\Omega$.
Signal discrimination	Logical “1” -3V or below Logical “0” +3V or more

Communication format

Circuit type	3-wire, half-duplex
Transmission type	Digital binary serial
Data speed (baud rate)	9600bit/sec
Character length	8 bits
Parity bit	none
Stop bit	1 bit

(Data speed, character length, parity bit, and stop bit settings are fixed)

Connector pin-out

Connector D-sub 9-pin female (inch thread)

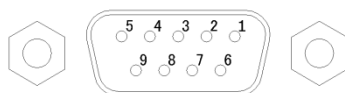

Terminal pin-out and input/output signals

Pin no	In/Out	Signal name	Description
1	-	NC	Not connected
2	In	Rx Data	Data received at this pin *
3	Out	Tx Data	Data transmitted from this pin
4	-	NC	Not connected
5	-	GND	Ground
6	-	-	Not connected
7	-	NC	Not connected
8	-	NC	Not connected
9	-	NC	Not connected

*A voltage that satisfies the RS-232C specification must be applied to Rx Data.

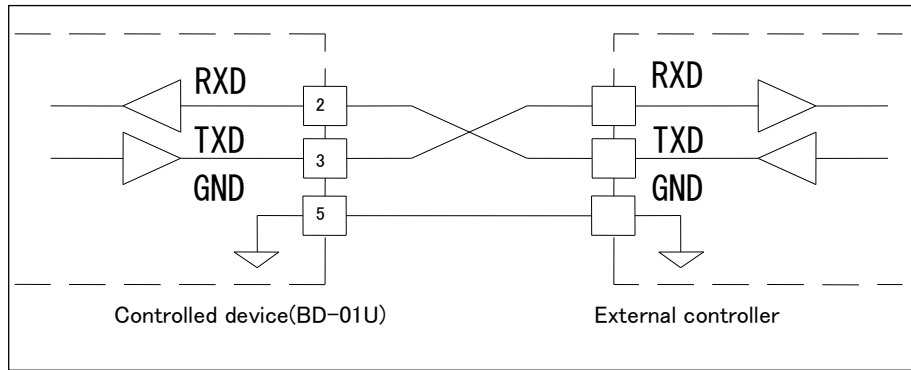

3. Protocol Overview

The Serial Control Protocol consists of three command characters and parameter characters of variable length. Characters are the ASCII Code.

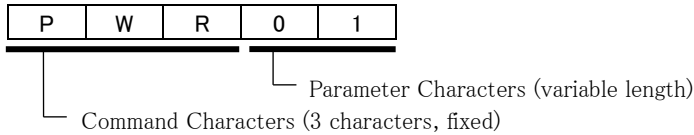

3.1 RS-232C Protocol

Controller → Device Message Example

Power On

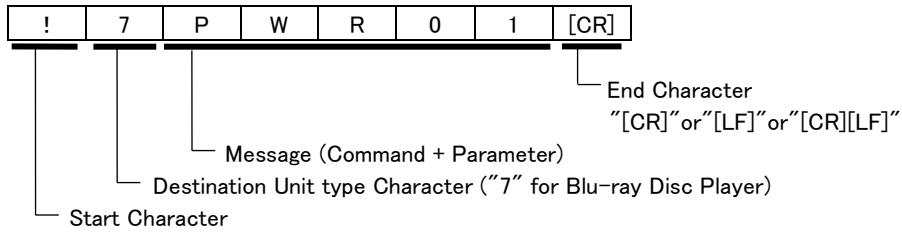

Device → Controller Message Example

Power Status = Standby

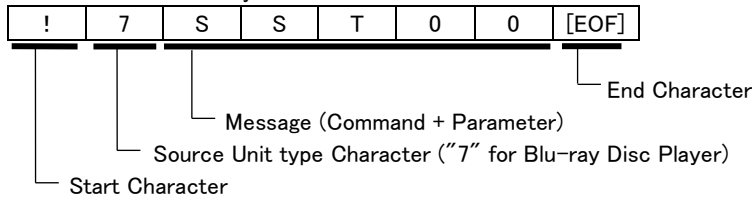

Special Characters

[CR]	Carriage Return	ASCII Code 0x0D
[LF]	Line Feed	ASCII Code 0x0A
[EOF]	End of File	ASCII Code 0x1A

3.2 ETHERNET Protocol

Protocol is TCP. (Transmission Control Protocol)

Destination Port Number is 60128. (fixed)

Finding the BD-01U's Ethernet MAC address : Please confirm the BD Player's MAC address on the setup menu in the BD Player.

Packet Format

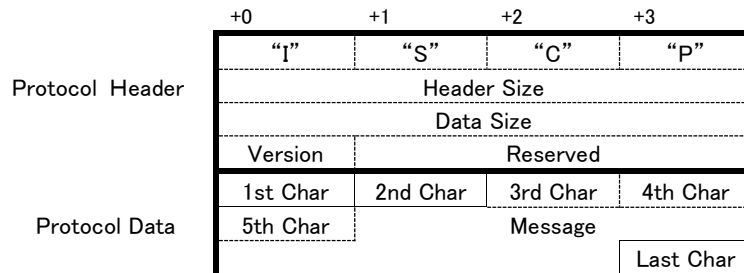

Power Status = Standby

1st Char	2nd Char	3rd Char	4th Char	5th Char	6th Char	7th Char	Last Char
!	7	P	W	R	0	1	[CR]

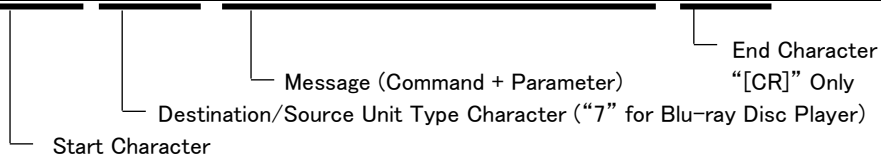

Header Size is the size of Protocol Header. Currently, it is 0x00000010. (Big-endian)

Data Size is the size of Protocol Data. (Big-endian)

Version is the protocol version. Currently, it is 0x01.

Reserved is for future use. It should be set to 0x000000 in version 1.

Unit Type is the model category ID. The Blu-ray player is "7".

Note: The connection between server and client should be held open continuously.

If the connection is closed, the client will not be able to see Status notification messages from the server.

Note: Only one client connection at a time can be made.

Note: Messages from the clients should have at least 50ms between them to allow for processing time.

4. COMMUNICATION FLOW DESCRIPTION

The Blu-ray Disc Player uses Question, Command and Notification messages to communicate with a given Controller.

This protocol is designed for point to point communication between a third party controller and the Blu-ray Disc Player.

4.1 Command Communication

Send a "Command Message" to the Blu-ray Disc Player from the Controller for control of the device.

Unsolicited feedback - If the Blu-ray Disc Player 's status changes , a "Status Message" is sent to the Controller (provided that the "PMS01" Command has been sent from the Controller to turn on this feature - unsolicited feedback is ON by default)

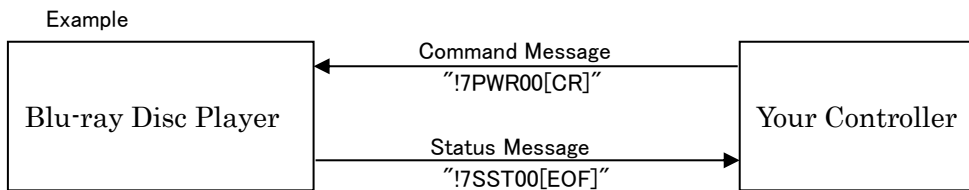

4.2 Question Communication

Send a "Question Message" to the Blu-ray Disc Player from the Controller to get the current system status. The Blu-ray Disc Player will respond with a status message.

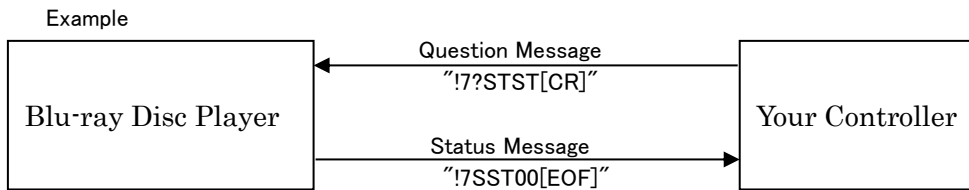

4.3 Event Notification Communication

If the system status changes, the Blu-ray Disc Player will notify the Controller by sending the new current status.

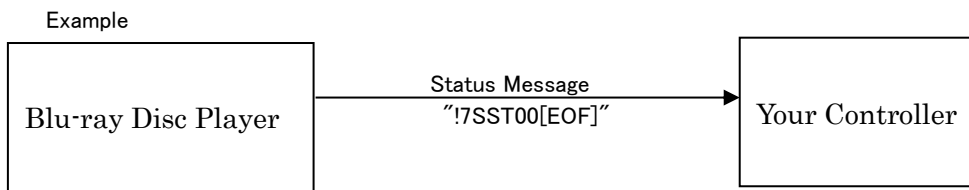

5. Command List

5.1 Command Communication

"Controller -> Blu-ray Disc Player" Command List

Code	Meaning
"PWR" – System Power Command	
"00"	Set System Standby
"01"	Set System On
"02"	Toggle between Standby and On (Remote Control STANDBY/ ON)
"OPC" – Open/Close Command	
	Open or Close the tray (Remote Control OPEN/CLOSE)
"OSD" – OSD Cursor Command	
"UP"	Up (Remote Control UP)
"DN"	Down (Remote Control DOWN)
"LF"	Left (Remote Control LEFT)
"RH"	Right (Remote Control RIGHT)
"CBC" – Color button Command	
"AB"	A (Remote Control RED)
"BB"	B (Remote Control GREEN)
"CB"	C (Remote Control BLUE)
"DB"	D (Remote Control YELLOW)
"ENT" – Enter Command	
	Enter (Remote Control ENTER)
"RET" – Return Command	
	Return (Remote Control RETURN)
"HOM" – Home Command	
	Home (Remote Control HOME)
"MNU" – Menu Command	
	Menu/Pop up Menu (Remote Control POP UP/MENU)
"TMN" – Title Command	
	Title (Remote Control TOP MENU)
"DSP" – Display Command	
	Display (Remote Control ON SCREEN)
"PIP" – PIP On/Off command	
"TG"	On/Off Toggle
"ON"	On
"OF"	Off
"ANG" – Angle Command	
	Angle
"AUD" – Audio Command	
	Audio (Remote Control AUDIO)
"SUB" – Subtitle Change Command	
	SubTitle (Remote Control SUB TITLE)
"PLY" – Play Command	
"UP"	Fwd (Remote Control PLAY)
"STP" – Stop Command	
	Stop (Remote Control STOP)
"PAS" – Pause Command	
	Pause (Remote Control PAUSE)
"SKP" – Skip Command	
"UP"	Up (Remote Control SKIP UP)
"DN"	Down (Remote Control SKIP DOWN)

"Controller -> Blu-ray Disc Player" Command List (continued)

Code	Meaning
"SCN" – Scan Command	
"UP"	FF (Remote Control FF)
"DN"	FR (Remote Control FR)
"NUM" – Numeric Selecting Command	
"01"–"09"	Set one digit number (Remote Control 1 – 9)
"00"	Set number "0" or number "10" (Remote Control 0)
"SRC" – Search Command	
	Search (Remote Control SEARCH)
"RPT" – Repeat Function Command	
	Toggle Repeat Function on/off (Remote Control REPEAT)
"ABR" – A-B Repeat Command	
	A-B Repeat (Remote Control A-B)
"PLM" – Play Mode Command	
TG	Play ModeToggle (Remote Control MODE)
"CLR" – Clear Command	
	Clear selection and memories
"DIM" – Dimmer Command	
"DN"	Change Dimmer Level by one step. (Remote Control DIMMER)
"00"	Bright
"02"	Dark
"07"	Auto
"CML" – Language command (Player Menu)	
"EN"	English (Japan, North America, Europe)
"FR"	French (North America, Europe)
"SP"	Spanish (North America, Europe)
"GE"	Deutsch (North America, Europe)
"IT"	Italian (North America, Europe)
"JP"	Japanese (Japan)
"INI" – Initialize command	
"00"	Start initialization Can only be used when status is "No Disc".
"01"	Reset default settings for Setup Menu Items (excluding Parental level) *
"CCR" – CEC SETUP CEC Control command	
"TG"	CEC Control Enable/Disable Toggle *
"ON"	CEC Control Enable *
"OF"	CEC Control Disable *
"EWC" – E-control SETUP E-control Power Control command	
"TG"	E-control Power Control Enable/Disable Toggle
"ON"	E-control Power Control Enable
"OF"	E-control Power Control Disable
"MAU" – HDMI Audio command	
"00"	Multi (Normal) *
"02"	Multi (LPCM) *
"FF"	Off *
"PMS" – Status mode Command	
"00"	Don't send status notification messages
"01"	Send status notification messages when the status changes
"02"	Don't send notification messages for No/Time
"03"	Send status notification messages when No/Time changes.

* Only recognized when the status is "Stop".

"Controller -> Blu-ray Disc Player" Command List (continued)

Picture	
Code	Meaning
"ASC" - Aspect Change command	
"00"	4:3 Letter box
"01"	4:3 Normal
"02"	16:9 Widescreen
"03"	16:9 Squeeze
"RSC" - Resolution Change command	
"TG"	Toggle*
"01"	sets Auto*
"02"	sets 480p/576p* 576p: for Europe model
"03"	sets 720p*
"04"	sets 1080i*
"05"	sets 1080p*
"07"	sets 1080p24*

* Only recognized when the status is "Stop".

5.2 Question Communication

Please also see "Feedback List" below for reply message.

"Controller -> Blu-ray Disc Player" Command List (status request)

Code	Meaning
"?ST" - Status request Command	
"ST"	Action Status Notification
"DS"	current disc status Notification
"MS"	Dimmer Function status Notification
"AS"	Aspect Ratio Status Notification
"RS"	Resolution Setup Status Notification
"MA"	HDMI Audio Setup Status Notification
"MT"	HDMI Output Setup status Notification
"?SN" - No/Time Status request Command	
"TG"	Title/Group/Folder No Status Notification
"TC"	Chapter/Track No Status Notification
"ET"	Elapsed Time Status Notification
"?SV" - Video Status request Command	
"MO"	HDMI Out picture resolution Notification
"?SC" - Setup Status request Command	
"ML"	Language Status Notification
"CR"	CEC SETUP CEC Control Status Notification

5.3 Event Notice Communication

"Blu-ray Disc Player -> Controller" Feedback List

Code	Meaning
"SPM" - Status mode notification	
"00"	Won't send status change notifications
"01"	Will send status change notifications
"02"	Won't send No/Time status change notifications
"03"	Will send No/Time status change notifications
"SST" - Action Status notification	
"00"	Standby
"01"	Playback
"02"	Playback Pause
"03"	Stop
"FF"	Unknown
"DST" - Current disc status notification	
"00"	No disc
"01"	DVD
"04"	CD
"07"	CD DATA (MP3/WMA/JPEG etc)
"10"	BD-ROM
"12"	USB (MP3/WMA/JPEG etc)
"FF"	Unknown
"MST" - Dimmer Level Status notification	
"00"	Dimmer Level is "Bright"
"02"	Dimmer Level is "Dark"
"07"	Dimmer Level is "Auto"
"FF"	Unknown
"AST" - Aspect Ratio Status notification *	
"00"	4:3 Letter box
"01"	4:3 Normal
"02"	16:9 Widescreen
"03"	16:9 Squeeze
"FF"	unknown/other
"STG" - Title/Group/Folder No Status notification	
ccctt	c:Current Title
	t:Total Title
e.g. "!7STG012255" Current 012/Total 255	
e.g. "!7STG012---" Current 012/Total unknown	
e.g. "!7STG-----" Current unknown/Total unknown	
"STC" - Chapter/Track No Status notification	
ccctt	c:Current Chapter/Track
	t:Total Chapter/Track
e.g. "!7STC012255" Current 012/Total 255(Up to 999)	
e.g. "!7STC-----" Current unknown/Total unknown	

* This is the aspect ratio set in the menu, NOT the current disc's aspect ratio.

"Blu-ray Disc Player → Controller" Feedback List (continued)

Code	Meaning
"SET" – Elapsed Time Status notification	
hmmss	h:Elapsed Hour
	m:Elapsed minute
	s:Elapsed Second
e.g. "!7SET-0001" Elapsed Time 00:01	
e.g. "!7SET " Elapsed Time unknown	
"SMO" – HDMI Out picture resolution status notification	
"00"	No Video Code
"02"	720(1440, 2880) x 480p 60Hz
"04"	1280x 720P 16:9 60Hz
"05"	1920x1080I 16:9 60Hz
"16"	1920x1080P 16:9 60Hz
"17"	720(1440, 2880) x 576p 50Hz *
"19"	1280x 720P 16:9 50Hz *
"20"	1920x1080I 16:9 50Hz *
"31"	1920x1080P 16:9 50Hz *
"32"	1920x1080P 16:9 24Hz
"35"	1280x 720P 16:9 100Hz
"36"	1280x 720P 16:9 120Hz
"37"	1920x1080P 16:9 48Hz
"FF"	Unknown/Other
"SCM" – Language status notification	
"EN"	English (Japan, North America, Europe)
"FR"	French (North America, Europe)
"SP"	Spanish (North America, Europe)
"GE"	Deutsch (North America, Europe)
"IT"	Italian (North America, Europe)
"JP"	Japanese (Japan)
"SCC" – CEC Control Setup status notification	
"ON"	CEC Control Setup Enable
"OF"	CEC Control Setup Disable
"SMR" – HDMI Resolution Setup status notification	
"01"	Auto
"02"	480p/576p 576p: for Europe model
"03"	720p
"04"	1080i
"05"	1080p
"07"	1080p24
"FF"	Unknown
"SMA" – HDMI Audio Setup status notification	
"00"	Multi(Normal)
"02"	Multi(LPCM)
"FF"	Off

* Only for Europe.