

oppo®

USER MANUAL

READ CAREFULLY BEFORE OPERATION

Blu-ray Disc Player BDP-103

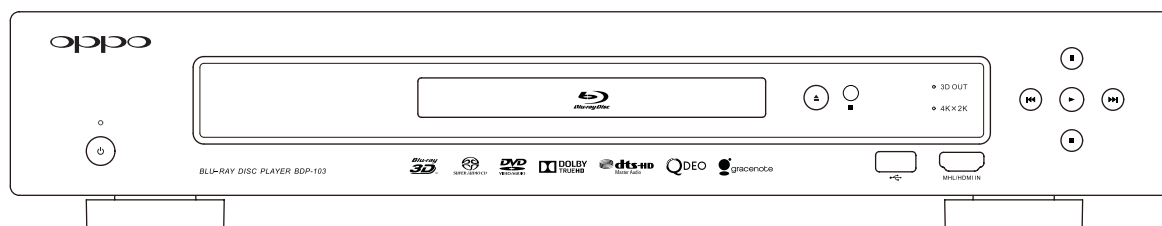

Table of Contents

IMPORTANT INFORMATION	1
Important Safety Instructions	1
Precautions	2
FCC Statement	2
Trademarks	3
Compatible Disc Types	3
Discs that cannot be played.....	4
Notes about BD-ROM compatibility	4
Disc care and handling	4
Copyright Protection	4
Cinavia Notice	4
Gracenote Notice	5
Region management information	5
Accessories	5
INSTALLATION	6
Front Panel Controls	6
Front Panel Display Windows	6
Rear Panel Connectors	7
Remote Control	8
Remote Control Buttons.....	8
Back Side.....	9
Battery Installation	9
Using the Remote Control.....	9
Changing the Remote Code.....	10
Changing the Backlight Method	10
Common Connection Methods	11
Connecting to an A/V Receiver via HDMI	11
Connecting to a TV and A/V Receiver via Dual HDMI	12
Connecting to a TV via HDMI	13
Connecting to Two TVs via HDMI.....	14
Connecting to a TV via DVI.....	15
Alternate Audio Connections	16
Connecting to an A/V Receiver or Amplifier via Analog Outputs	16
Connecting to an A/V Receiver or Amplifier via S/PDIF (Coaxial / Optical).....	17
HDMI / MHL INPUT to BDP-103	18
Connecting to the Internet	19
Internet connection through Ethernet cable	19

Internet connection through wireless adaptor	20
Custom Installation	21
External IR (Infrared Remote) Installation	21
RS232 Control.....	21
Quick Start Guide	22
Power On and Play	22
Select the Best Output Resolution	22
Determine the Display Aspect Ratio	23
BASIC OPERATIONS	24
Disc Playback	24
OPTION Menu.....	24
Fast Playback	25
Pause and Frame-by-Frame	25
Slow Playback.....	26
Blu-ray Disc Menu Playback.....	26
DVD Menu Playback.....	26
On-Screen Display.....	27
Volume Control	27
Mute.....	28
Audio Language/Track Selection	28
Subtitle Selection	28
HDMI / MHL INPUT Selection	29
Audio Return Channel (ARC) Selection.....	29
BD-Live	30
ADVANCED OPERATIONS	31
Output Resolution	31
Zooming and Aspect Ratio Control	32
Zoom Levels for HDMI Output	32
Subtitle Shift	34
Repeat Playback.....	34
Repeat a Selected Section.....	35
Shuffle and Random Playback	35
Playback by Chapter or Track Number.....	35
Playback from a Specific Location	36
DVD and Blu-ray Discs	36
CD and SACD Discs.....	37
Memory and Automatic Resume	38
Viewing Pictures on DVD-Audio Discs	38
Pure Audio Mode.....	38

MEDIA FILE PLAYBACK	40
Playback from USB Flash Drive	40
In-home Network Media Sharing	41
Internet Streaming on HOME Menu	42
Playing Music Files	43
Playing Movie Files	45
Viewing Photo Files	46
Adding Background Music	47
SETUP MENU OPTIONS	48
Using the Setup Menu System.....	48
Playback Setup	51
Video Setup	53
Picture Adjustment.....	56
HDMI Options	59
Audio Format Setup	61
Audio Signal Reference Chart	64
Recommended Audio Format Options	65
Audio Processing Setup.....	67
Speaker Configuration	67
Other Audio Processing Settings	71
Device Setup	73
Network Setup	77
REFERENCES.....	81
Useful Notes	81
Troubleshooting	81
Specifications	83
User Manual Updates Online	83
Language Code List	84
Gracenote Terms of Use	85
LIMITED WARRANTY.....	86
OPPO Digital, Inc. Limited Two Years Warranty.....	86

IMPORTANT INFORMATION



CAUTION
RISK OF ELECTRIC SHOCK.
DO NOT OPEN.



CAUTION: TO REDUCE THE RISK OF ELECTRIC SHOCK, DO NOT REMOVE COVER (OR BACK). NO USER-SERVICEABLE PARTS INSIDE. REFER SERVICING TO QUALIFIED SERVICE PERSONNEL.

 The lightning flash with arrowhead symbol, within an equilateral triangle, is intended to alert the user to the presence of uninsulated "dangerous voltage" within the product's enclosure that may be of sufficient magnitude to constitute a risk of electric shock to persons.

 The exclamation point within an equilateral triangle is intended to alert the user to the presence of important operation and maintenance (servicing) instruction in the literature accompanying the appliance.

WARNING:

TO REDUCE THE RISK OF FIRE OR ELECTRIC SHOCK, DO NOT EXPOSE THIS APPLIANCE TO RAIN OR MOISTURE. DANGEROUS HIGH VOLTAGES ARE PRESENT INSIDE THE ENCLOSURE. DO NOT OPEN THE CABINET. REFER SERVICING TO QUALIFIED PERSONNEL ONLY.

THE APPARATUS SHALL NOT BE EXPOSED TO DRIPPING OR SPLASHING AND THAT NO OBJECTS FILLED WITH LIQUIDS, SUCH AS VASES SHALL BE PLACED ON THE APPARATUS.

Important Safety Instructions

- 1) Read these instructions.
- 2) Keep these instructions.
- 3) Heed all warnings.
- 4) Follow all instructions.
- 5) Do not use this apparatus near water.
- 6) Clean only with dry cloth.
- 7) Do not block any ventilation openings. Install in accordance with the manufacturer's instructions.
- 8) Do not install near any heat sources such as radiators, heat registers, stoves, or other apparatus (including amplifiers) that produce heat.
- 9) Do not defeat the safety purpose of the polarized or grounding-type plug. A polarized plug has two blades with one wider than the other. A grounding type plug has two blades and a third grounding prong. The wide blade or the third prong is provided for your safety. If the provided plug does not fit into your outlet, consult an electrician for replacement of the obsolete outlet.
- 10) Protect the power cord from being walked on or pinched, particularly at plug, receptacle, and the point where it exits from the apparatus.

CAUTION:

DANGER OF EXPLOSION IF BATTERY IS INCORRECTLY REPLACED. REPLACE ONLY WITH THE SAME OR EQUIVALENT TYPE.

THIS PRODUCT UTILIZES A LASER. USE OF CONTROLS OR ADJUSTMENTS OR PERFORMANCE OF PROCEDURES OTHER THAN THOSE SPECIFIED HEREIN MAY RESULT IN HAZARDOUS RADIATION EXPOSURE. DO NOT OPEN COVERS AND DO NOT REPAIR YOURSELF. REFER SERVICING TO QUALIFIED PERSONNEL.

**CLASS I LASER
PRODUCT**

CAUTION CLASS 3R VISIBLE AND INVISIBLE LASER RADIATION WHEN OPEN. AVOID DIRECT EYE EXPOSURE.

VORSICHT KLASSE 3R SICHTBARE UND UNSICHTBARE LASERSTRAHLUNG WENN GEÖFFNET. UNMITTELBAREN AUGENKONTAKT VERMEIDEN.

ADVARSEL SYNLIG OG USYNLIG LASERSTRÅLING AF KLASSE 3R VED ÅBNING. UNDGÅ AT SE DIREKTE PÅ STRÅLEN.

ADVARSEL SYNLIG OG USYNLIG LASERSTRÅLING I KLASSE 3R NÅR DEKSEL ÅPNES. UNNGÅ DIREKTE EKSPONERING AV ØYENENE.

WARNING KLASSE 3R SYNLIG OCH OSYNLIG LASERSTRÅLNING NÅR DENNA DEL ÄR ÖPPNAD. UNDVIK ATT DIREKT EXPONERA ÖGONEN FÖR STRÅLNINGEN.

VARO! AVATTUNA LUOKAN 3R NÄKYVÄÄ JA NÄKYMÄTÖNTÄ LASERSÄTEILYÄ. VÄLTÄ KATSEEN SUORAA ALTISTAMISTA.

警告 打开时有3R类可见和不可见激光辐射,避免眼睛受到直射的照射

This label is located on the laser protective housing inside the product.

- 11) Only use attachments/accessories specified by the manufacturer.
- 12) Use only with the cart, stand, tripod, bracket, or table specified by the manufacturer, or sold with the apparatus. When a cart is used, use caution when moving the cart/apparatus combination to avoid injury from tip-over.
- 13) Unplug this apparatus during lightning storms or when unused for long periods of time.
- 14) Refer all servicing to qualified service personnel. Servicing is required when the apparatus has been damaged in any way, such as power-supply cord or plug is damaged, liquid has been spilled or objects have fallen into the apparatus, the apparatus has been exposed to rain or moisture, does not operate normally, or has been dropped.
- 15) Batteries (battery pack or batteries installed) shall not be exposed to excessive heat such as sunshine, fire or the like.



Precautions

- Before connecting the AC power cord to the appliance, make sure the voltage designation of the appliance corresponds to the local electrical supply. If you are unsure of your power supply, contact your local power company. The acceptable power input range is AC ~ 100V-240V, 50/60Hz.
- The apparatus with CLASS I construction shall be connected to a MAINS socket outlet with a protective earthing connection.
- The player is still receiving power from the AC power source as long as it is connected to the wall outlet, even if the player itself has been turned off.
- Unplug the power cord if you are not going to use the product for an extended period of time. Hold the power plug when unplugging. Do not pull on the cord.
- The main plug is used as the mechanism for cutting off power, therefore make sure it is easy to unplug.
- To ensure proper ventilation around this product, do not place this product on a sofa, bed or rug. When installing this product on a wall or bookshelf, you need to provide appropriate space: we recommend leaving 4 inches (10 cm) of free space at the top, the sides and the rear.
- High temperature will lead to abnormal operation of this unit. Do not expose this unit or batteries to direct sunlight or near other heating objects.
- When moving the player from a cold location to a warm one, or vice versa, moisture may condense on the laser pickup unit inside the player. Should this occur, the player may not operate properly. In such a case please turn the unit on for 1-2 hours (without a disc) to facilitate moisture evaporation.

FCC Statement

This equipment has been tested and found to comply with the limits for a Class B digital device, pursuant to Part 15 of the FCC Rules. These limits are designed to provide reasonable protection against harmful interference in a residential installation. This equipment generates, uses, and can radiate radio frequency energy and, if not installed and used in accordance with the instructions, may cause harmful interference to radio communications. However, there is no guarantee that interference will not occur in a particular installation. If this equipment does cause harmful interference to radio or television reception, which can be determined by turning the equipment off and on, the user is encouraged to try to correct the interference by one or more of the following measures:

- Reorient or relocate the receiving antenna.

- Increase the separation between the equipment and receiver.
- Connect the equipment into an outlet on a circuit different from that to which the receiver is connected.
- Consult the dealer or an experienced radio/TV technician for help.











Any unauthorized changes or modifications to this equipment would void the user's authority to operate this device.

This device complies with Part 15 of the FCC Rules. Operation is subject to the following two conditions: (1) This device may not cause harmful interference, and (2) this device must accept any interference received, including interference that may cause undesired operation.

Trademarks

- “Blu-ray Disc”, “Blu-ray 3D”, “BONUSVIEW” and “BD-Live” are trademarks of Blu-ray Disc Association.
- Java and all Java-based trademarks and logos are trademarks or registered trademarks of Sun Microsystems, Inc. in the United States and other countries.
- DVD Logo is a trademark of DVD Format/Logo Licensing Corp., registered in the U.S., Japan and other countries.
- Super Audio CD, SACD and the SACD logo are joint trademarks of Sony Corporation and Philips Electronics N.V. Direct Stream Digital (DSD) is a trademark of Sony Corporation.
- “AVCHD” and the “AVCHD” logo are trademarks of Panasonic Corporation and Sony Corporation.
- Designed for Windows Media, Microsoft, HDCD, and the HDCD logo are trademarks or registered trademarks of Microsoft Corporation in the United States and/or other countries.
- “480i/480p/720p/1080i/1080p” up-converting arrow logo, “Source Direct” and “True 24p” logos are trademarks of OPPO Digital, Inc.
- “Netflix” is a registered trademark of Netflix, Inc.
- “Qdeo” is trademark of Marvell or its affiliates.
- Manufactured under license under U.S. Patent Nos: 5,956,674; 5,974,380; 6,226,616; 6,487,535; 7,212,872; 7,333,929; 7,392,195; 7,272,567 & other U.S. and worldwide patents issued & pending. DTS-HD, the Symbol, & DTS-HD and the Symbol together are registered trademarks & DTS-HD Master Audio is a trademark of DTS, Inc. Product includes software. © DTS, Inc. All Rights Reserved.
- Manufactured under license from Dolby Laboratories. Dolby and the double-D symbol are trademarks of Dolby Laboratories.
- HDMI, the HDMI logo and High-Definition Multimedia Interface are trademarks or registered trademarks of HDMI Licensing LLC.
- “Pandora” is trademark of Pandora, Inc.
- “Gracenote” is trademark of Gracenote, Inc.
- “Cinavia” is trademark of Verance Corporation.
- All other trademarks are the properties of their respective owners.

Compatible Disc Types

Logo	Features	Manual Icon
	BD: Supports Blu-ray with Bonus View and BD-Live content, including Blu-ray 3D discs. A 3D-capable display with compatible glasses is required for 3D playback. BD-R/RE, both single- and dual-layer are also supported.	
	DVD: Plays commercially-released DVDs, as well as finalized DVD±R/RW.	
	DVD-A: High-resolution stereo or multi-channel audio. Some DVD-Audio discs also contain a DVD-Video portion.	
	SACD: High-resolution stereo or multi-channel audio. Note: some SACDs use a hybrid format with both a CD and a high resolution DSD layer.	
	CD: Supports standard Red Book CDs, as well as HDCD and CD-R/RW.	
	AVCHD: High-definition digital video camera format, often in the form of a DVD±R or flash memory.	

Discs that cannot be played

- BDs with cartridge
- DVD-RAMs
- HD-DVDs
- Data portion of CD-Extras
- DVDs / Blu-Rays with a region code other than 1 or A
- Some Dual-Discs: A Dual-Disc is a two-sided disc with DVD-video on one side and digital audio on the other side. The digital audio side does not meet the technical specifications of the Red Book CD format so playback is not guaranteed.
- Audio discs with copy-protection may not be playable.

Notes about BD-ROM compatibility

Since the Blu-ray Disc specifications are new and evolving, some discs may not play properly depending on the disc type, version and encoding. It is possible that a Blu-ray Disc manufactured after the player uses new features of the Blu-ray Disc specifications. To ensure the best possible viewing experience, the player may need a firmware or software update from time to time. Please visit OPPO Digital's web site www.oppodigital.com to check if updates are available.

Disc care and handling

- To keep the disc clean from scratches or fingerprints, handle the disc by its edge. Do not touch the recorded surface.
- Blu-ray Discs record data in very high density and the recorded layer is very close to the disc surface. For this reason, Blu-ray Discs are more sensitive to dust and fingerprints than DVD. Should you encounter playback problems and see dirty spots on the disc surface, clean the disc with a cleaning cloth. Wipe the disc from the center out along the radial direction. Do not wipe the disc in a circular motion.
- Do not use record cleaning sprays or solvents such as benzene, thinner and anti-static spray.
- Do not attach labels or stickers to discs as this may cause the disc to warp or become too thick, resulting in playback issues and a potentially stuck disc.
- Avoid exposing the discs to direct sunlight or heat sources.
- Do not use the following discs:
 - Discs with exposed adhesive from removed stickers or labels. The disc may get stuck inside the player.
 - Warped or cracked discs.
 - Irregularly shaped discs, such as heart or business card shapes.

Copyright Protection

This product incorporates copyright protection technology that is protected by U.S. patents and other intellectual property rights of Rovi Corporation. The use of Rovi Corporation's copyright protection technology in the product must be authorized by Rovi Corporation. Reverse engineering and disassembly are prohibited.

Cinavia Notice

This product uses Cinavia technology to limit the use of unauthorized copies of some commercially-produced film and videos and their soundtracks. When a prohibited use of an unauthorized copy is detected, a message will be displayed and playback or copying will be interrupted.

More information about Cinavia technology is provided at the Cinavia Online Consumer Information Center at <http://www.cinavia.com>. To request additional information about Cinavia by mail, send a postcard with your mailing address to: Cinavia Consumer Information Center, P.O. Box 86851, San Diego, CA, 92138, USA.

IMPORTANT INFORMATION

Gracenote Notice

Music and Video recognition technology and related data are provided by Gracenote®. Gracenote is the industry standard in music and video recognition technology and related content delivery. For more information visit www.gracenote.com.

CD, DVD, Blu-ray Disc, and music and video-related data from Gracenote, Inc., copyright © 2000 to present Gracenote. Gracenote Software, copyright © 2000 to present Gracenote. One or more patents owned by Gracenote may apply to this product and service. See the Gracenote website for a non-exhaustive list of applicable Gracenote patents. Gracenote, CDDB, MusicID, the Gracenote logo and logotype, and the "Powered by Gracenote" logo are either registered trademarks or trademarks of Gracenote in the United States and/or other countries.

Region management information

This player is designed and manufactured to respond to the region management information. If the region number of a BD-Video or DVD disc does not correspond to the region number of this player, this player cannot play the disc.

BD-Video: This player plays Blu-Ray Discs with marks containing the region code A.



DVD-Video: This player plays DVDs with marks containing the region code 1 and ALL.



Accessories

Please check that the following parts are included in your BDP-103 package:



User Manual



HDMI 1.4 Cable, about 6 feet



USB Wireless-N Adapter (up to 150Mbps, 802.11b/g/n compatible, 2.4GHz)



USB Extension Cable, about 4.5 feet



Power Cable, about 4.5 feet



Remote Control with AA Batteries

INSTALLATION

Front Panel Controls

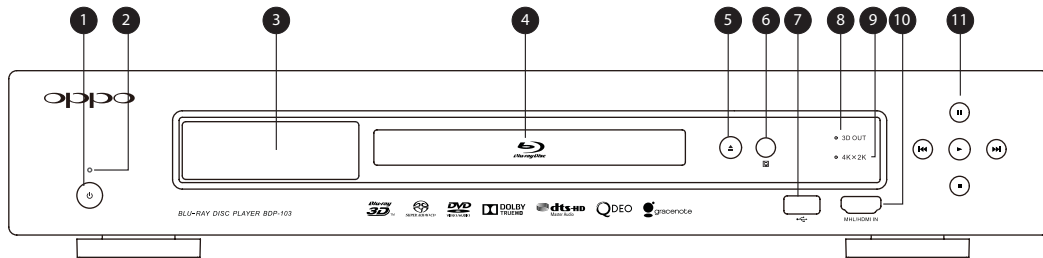

- | | | | |
|-------------------------------|--|------------------------------------|---|
| 1. POWER Button | 4. Disc Tray | 7. USB 2.0 Input | 10. MHL-Compatible HDMI Input |
| 2. POWER Status Indicator | 5. OPEN/CLOSE Tray Button (with backlight) | 8. 3D Output Active Indicator | 11. Playback Control and Navigation Buttons |
| 3. Front Panel Display Window | 6. IR Sensor Window | 9. 4K x 2K Output Active Indicator | |

Front Panel Display Windows

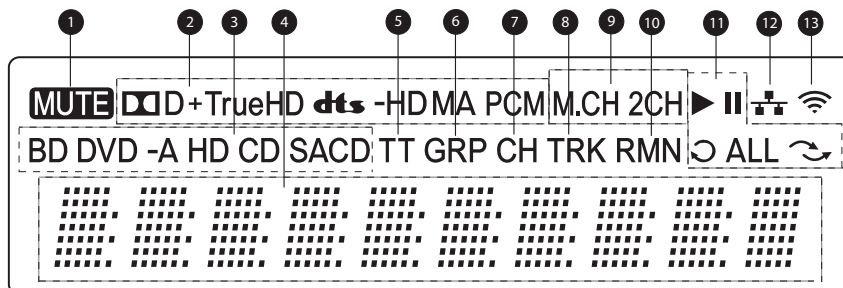

- | | |
|--|--|
| 1. Mute Icon – Indicates that the audio is muted | 8. Track – When illuminated, the displayed time applies to a track |
| 2. Audio Type Indication – Indicates the type of audio tracks being played | 9. Audio Channel Indication – Indicates whether the audio being played is 2ch stereo or multi-channel surround |
| 3. Disc Type Indication – Indicates the currently playing disc type | 10. Remaining – When illuminated, the displayed time is the remaining play time |
| 4. Main Display – Text messages and numeric display | 11. Playback Status – Indicates playback status such as Play, Pause, Repeat, Repeat All, and Random Mode |
| 5. Title – When illuminated, the displayed time applies to a title | 12. Ethernet – Indicates that an active Ethernet cable is attached |
| 6. Group – When illuminated, the displayed time applies to a group | 13. Wireless – Indicates that the player is connected to a wireless network |
| 7. Chapter – When illuminated, the displayed time applies to a chapter | |

Rear Panel Connectors

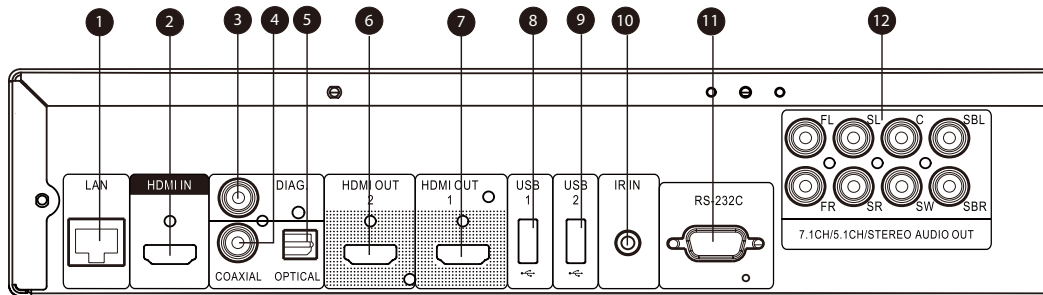

- | | | |
|---------------------------------|----------------------------------|---|
| 1. Ethernet LAN Port | 6. HDMI 2 Output (3D Compatible) | 11. RS-232C Serial Control Port |
| 2. HDMI Input (Back) | 7. HDMI 1 Output (3D Compatible) | 12. 7.1CH / 5.1CH / Stereo Analog Audio Outputs |
| 3. Diagnostic Video Output | 8. USB 2.0 Input | |
| 4. Coaxial Digital Audio Output | 9. USB 2.0 Input | |
| 5. Optical Digital Audio Output | 10. IR (Infrared) Signal Input | |

In addition to the above connectors, the AC power inlet is also located on the rear panel. The inlet is the IEC60-320 C14 type. Only the included AC power cord or an approved power cord with an IEC60-320 C14 type plug should be used.

Remote Control

Remote Control Buttons

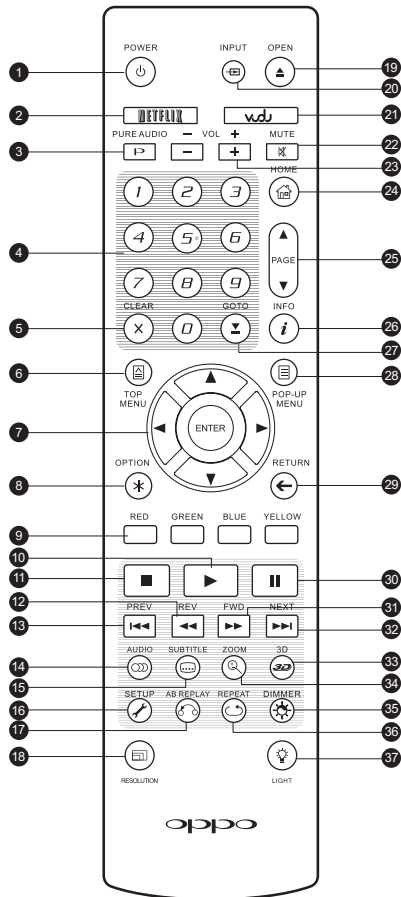

1. **POWER:** Toggle power STANDBY and ON
2. **NETFLIX:** Netflix access button
3. **PURE AUDIO:** Turn off/on video

4. **NUMBER Buttons:** Enter numeric values
5. **CLEAR:** Clear numeric input
6. **TOP MENU:** Show BD top menu or DVD title menu
7. **ARROW and ENTER Buttons:** Navigate menu selection
8. **OPTION:** Brings up the context-related menu
9. **COLOR Buttons:** Function varies by content
10. **PLAY:** Start playback
11. **STOP:** Stop playback
12. **REV:** Fast reverse play
13. **PREV:** Skip to previous
14. **AUDIO:** Change audio language or channel
15. **SUBTITLE:** Change subtitle language
16. **SETUP:** Enter the player Setup Menu
17. **A-B REPLAY:** Repeat play the selected section
18. **RESOLUTION:** Switch output resolution
19. **OPEN:** Open/close the disc tray
20. **INPUT:** Select the input source
21. **VUDU:** VUDU access button
22. **MUTE:** Mute audio
23. **VOLUME +/-:** Increase/Decrease volume
24. **HOME:** Go to Home Menu to select media source
25. **PAGE UP/DOWN:** Show the previous/next page
26. **INFO:** Show/hide the On-Screen Display
27. **GOTO:** Play from a specified location
28. **POP-UP MENU:** Show BD pop-up menu or DVD menu
29. **RETURN:** Return to the previous menu or mode
30. **PAUSE:** Pause playback
31. **FWD:** Fast forward play
32. **NEXT:** Skip to the next
33. **3D:** Enable 2D->3D conversion or bring the 3D adjustment menu
34. **ZOOM:** Zoom in/out and adjust aspect ratio
35. **DIMMER:** Dim the front panel display
36. **REPEAT:** Repeat play
37. **LIGHT:** Activate the back light for the remote control

NOTE

When a button is pressed but its function is invalid or unavailable at the moment, the TV screen displays a circle with a diagonal line:



Back Side

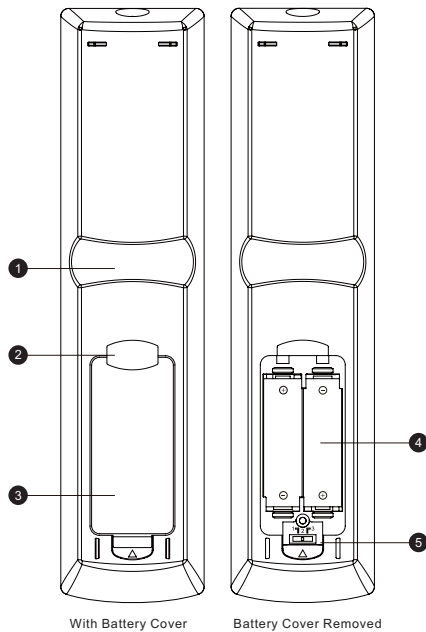

1. **Index Finger Notch 1:** When your index finger is placed at this notch while holding the remote control, your thumb is within easy reach of the navigation buttons (ARROW, ENTER, TOP MENU and POP-UP MENU).
2. **Index Finger Notch 2:** When your index finger is placed at this notch while holding the remote control, your thumb is within easy reach of the playback control buttons (STOP, PLAY, PAUSE, PREV, NEXT, REV, FWD).
3. **Battery Cover:** Remove to replace batteries or set remote code.
4. **Batteries:** Use 2 AA or LR6 batteries.
5. **Remote Code Switch:** Adjust the position of the switch to set the remote control to use the indicated remote code (see details on page 10).

Battery Installation

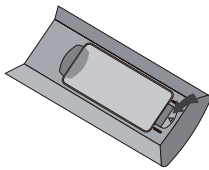

1. Remove the battery compartment cover

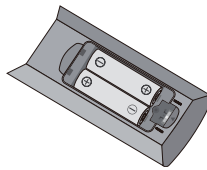

2. Insert batteries

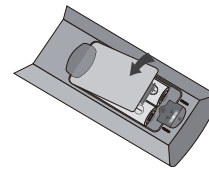

3. Replace the battery compartment cover

Using the Remote Control

When using the remote control, the front window of the remote control should be pointed to the infrared sensor on the front panel within an angle of $\pm 30^\circ$ and a range of about 26 ft.

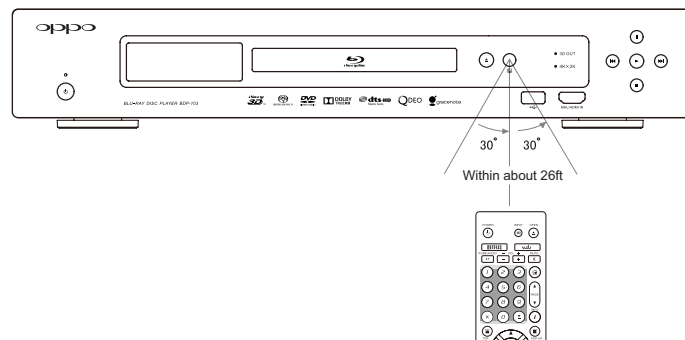

Changing the Remote Code

The remote control contains three OPPO remote codes. The default is “Code 1”. If you have other OPPO products placed close to the BDP-103, they may inadvertently respond to the BDP-103 remote control. To prevent this, you can select a different remote code.

To select a new remote code, open the battery compartment cover of the remote control, and then use a ball point pen to flip the switch to one of the positions marked as “1”, “2”, or “3”. Close the battery compartment cover. Make sure that the BDP-103 player is turned on and that the disc tray is ejected. Aim the remote control at the player. Press and hold the **ENTER** button for 5 seconds. The player will start using the new remote code.

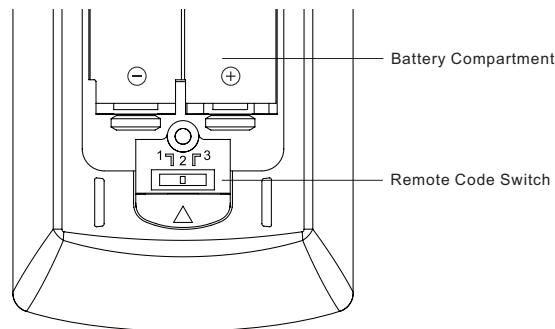

Changing the Backlight Method

The remote control supports one of two backlight methods. By default, pressing the **LIGHT** button will turn on the backlight, and pressing any other button within 10 seconds will keep the backlight on. The alternative method will activate the backlight whenever any button is pressed; in this mode, the light will stay on for 10 seconds, and pressing any other button will keep the backlight on. To switch between these two backlight methods, press and hold the **LIGHT** button for 5 seconds.

CAUTION

- Never drop the remote control or expose it to moisture.
- Never expose the infrared remote sensor on the front panel to direct sunlight or other strong light sources.
- Remote may not operate consistently when batteries become low. Replace them if operation deteriorates.
- If the remote control will not be used for a long time, please remove the batteries.
- Use the batteries correctly to avoid possible leakage and corrosion. Do not leave the batteries exposed to direct sunlight or in a high temperature environment for a long period of time. Do not heat or expose to flame. Do not mix old and new batteries. Do not use batteries of different types at the same time. Do not attempt to recharge the batteries.
- If battery leakage occurs, do not touch the liquid with bare hands. Wipe out any liquid inside the battery compartment, and insert new batteries.

Common Connection Methods

Connecting to an A/V Receiver via HDMI

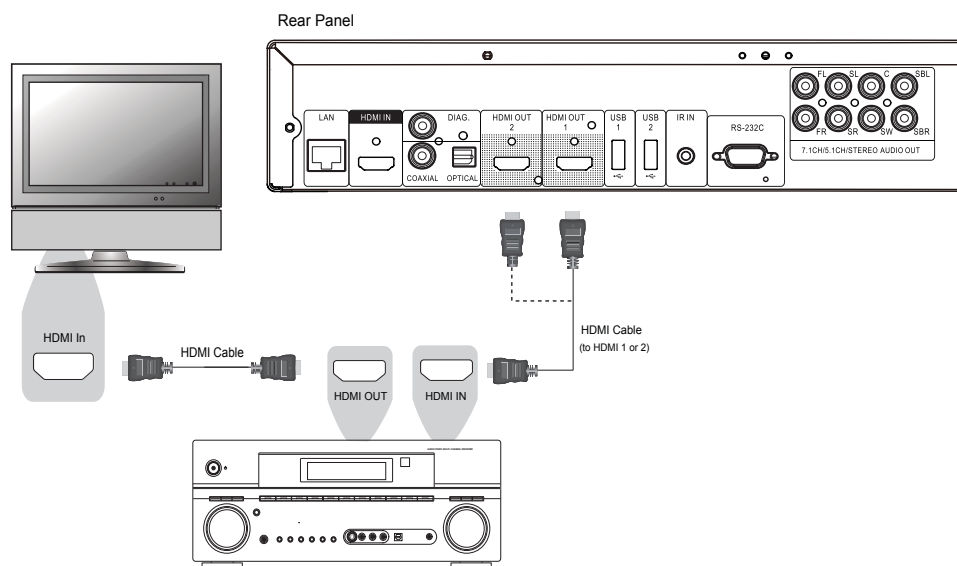

- If you have an HDMI-capable receiver that can support HDMI audio, you can simply run an HDMI cable from the player to your receiver and enable HDMI audio on the receiver (see your receiver's owner's manual for more information). The receiver usually has an HDMI output that you can connect to your TV to pass the video signal.
- Either of the two HDMI output terminals (HDMI 1 OUT and/or HDMI 2 OUT) on the rear panel of the BDP-103 can be connected to your receiver. Preference should be given to the HDMI 1 output for video since it is the only output to benefit from the superior Marvell QDEO video processor.

NOTE

HDMI (High-Definition Multimedia Interface) is a single cable that can transport both audio and video from your player to your display. Be aware, however, that HDMI is an evolving standard, and there may be compatibility issues. A receiver that supports audio input over HDMI is required. Some receivers offer HDMI ports solely for video switching. If your receiver does not have audio input capability, please read the following sections regarding other connection methods.

In order to play multi-channel audio for all formats, the receiver must support HDMI v1.1 or later. For Blu-ray Discs, a receiver that supports HDMI v1.4 with decoding capability for Dolby TrueHD and DTS-HD Master Audio is preferred. Please check the specifications of your receiver to ensure that it meets these requirements.

The HDMI outputs on the BDP-103 are HDMI v1.4, which are compatible with HDMI v1.3 and earlier versions.

Connecting to a TV and A/V Receiver via Dual HDMI

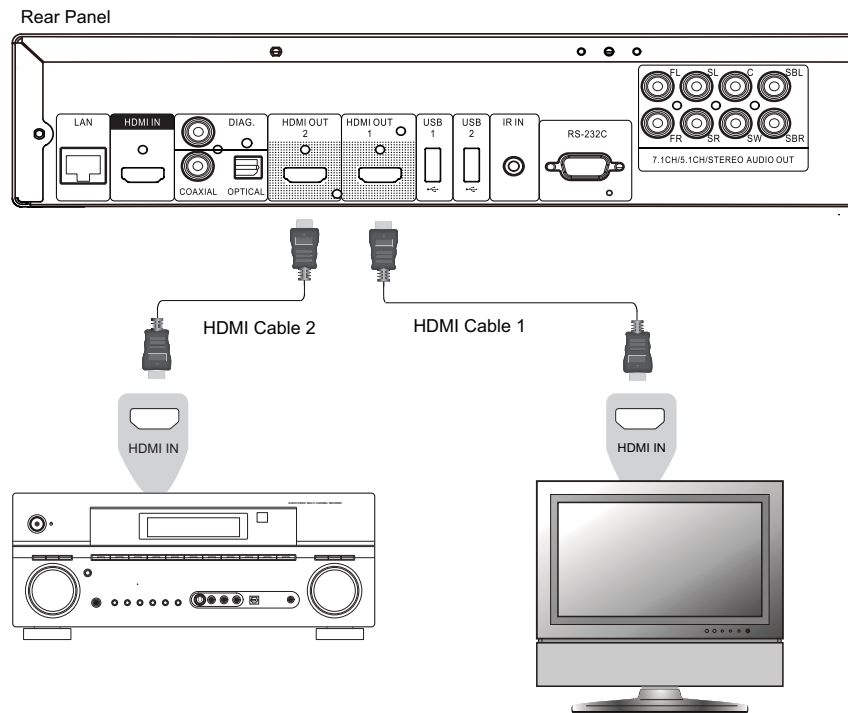

- The BDP-103 provides a “Dual HDMI” connection to make sure you can enjoy the highest possible video quality and resolution, in addition to high bit rate audio content. You can use the included HDMI cable to connect the HDMI 1 output to your HDTV and use another HDMI cable (not included) to connect the HDMI 2 output to your receiver by setting the **Dual HDMI Output** option in the **Setup Menu** to **Split A/V** (see page 53 for details). In this way you can utilize the dedicated video processor available for the HDMI 1 output, and allow your receiver which has no HDMI 1.4 inputs to work without any loss to the digital audio signals.
- This configuration is recommended when you have a 3D-compatible display, but your receiver is not 3D-compatible. This allows you to send the video signal (3D, in this case) directly to the TV and the audio signal to the receiver to be distributed to your speakers as it normally would.

NOTE

- Please refer to the notes on HDMI connections available on page 11.
- If your receiver does not have HDMI audio input capability, please try the alternate connection methods discussed on pages 16 and 17.

Connecting to a TV via HDMI

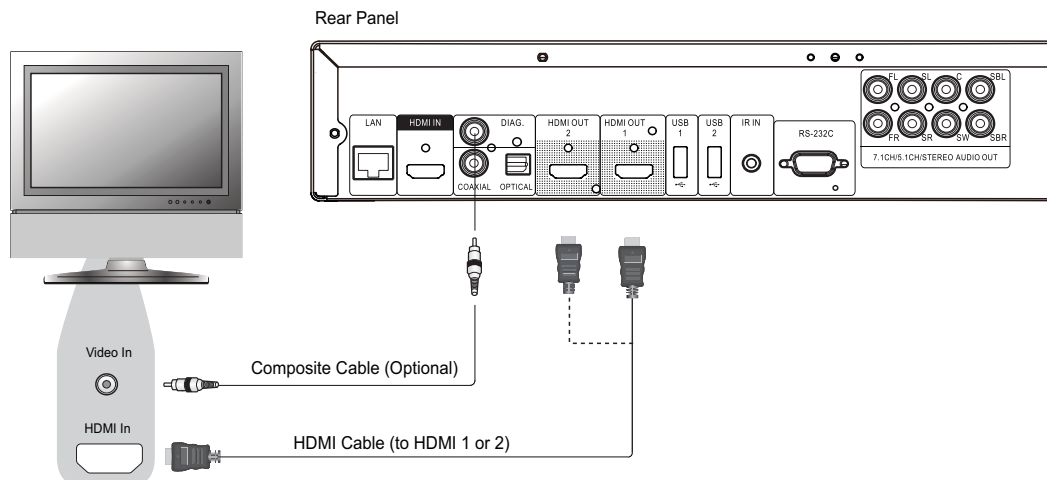

- If your TV has an HDMI input, you can use the included HDMI cable to connect the player directly to the TV. This connection method delivers both video and audio in a pure digital format via a single cable. The HDMI output of the player allows for the highest possible video quality and audio resolution.
- There are two HDMI output terminals (HDMI 1 OUT and HDMI 2 OUT) on the rear panel of BDP-103, both of which can be connected to your TV. We recommend using HDMI 1 OUT since it benefits from the dedicated Marvell QDEO video processor.
- You may remove the HDMI cable and connect the DIAG (diagnostic) output to the TV through a regular composite video cable (not included) when there is a problem with HDMI video. Only the **Setup Menu** will be visible on the TV when using this connection, so it is limited to troubleshooting purposes only.

NOTE

- This connection method will output sound via the TV's speakers. For optimal sound quality, it is recommended that audio be transferred from the BDP-103 to an A/V receiver with connected speakers.
- If your A/V receiver does not accept audio via HDMI, or if your receiver does not have HDMI inputs at all, see pages 16 and 17 for instructions on how to output audio to a receiver using different connection types.

Connecting to Two TVs via HDMI

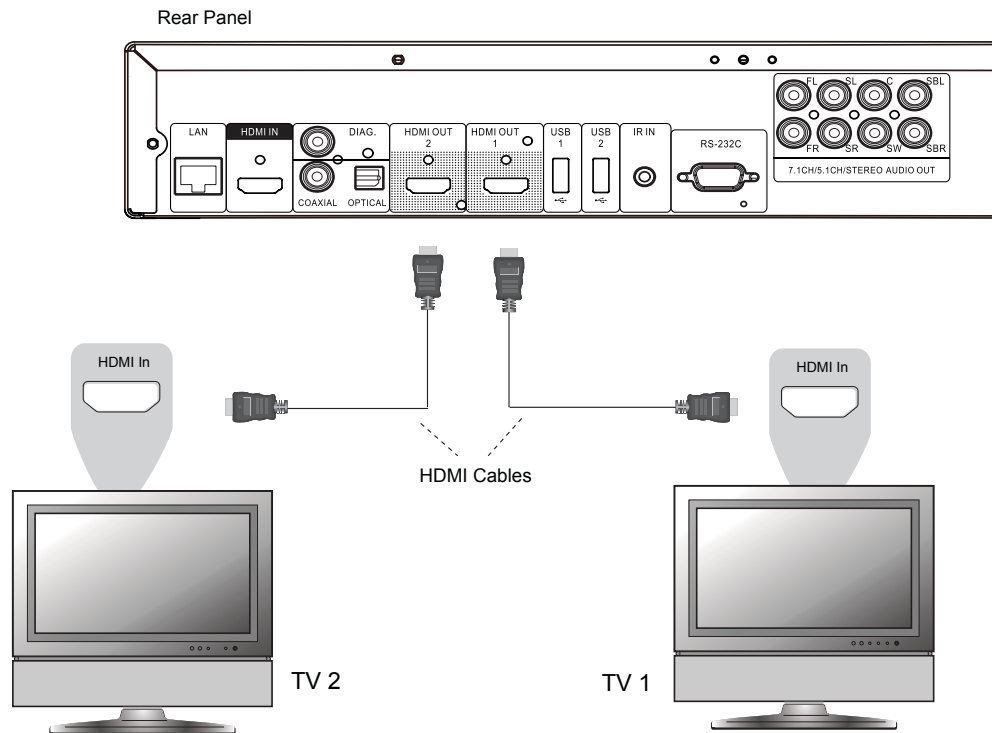

- The two HDMI outputs (HDMI 1 OUT and HDMI 2 OUT) available on the rear panel of BDP-103 can be connected to two TVs at the same time, and each output can deliver both digital video and audio signals.
- We recommend that you connect your main TV (the one with larger screen size or the one that you would watch more often) to HDMI 1 OUT in order to benefit from the dedicated video processor, and set the **Dual HDMI Output** option in the **Setup Menu** to **Dual Display** to make sure that the HDMI 2 OUT can also send out audio and video signals (see more details on page 53).
- You may connect the DIAG (diagnostic) output to one of your TVs for troubleshooting purposes. Refer to page 13 for more details.

Connecting to a TV via DVI

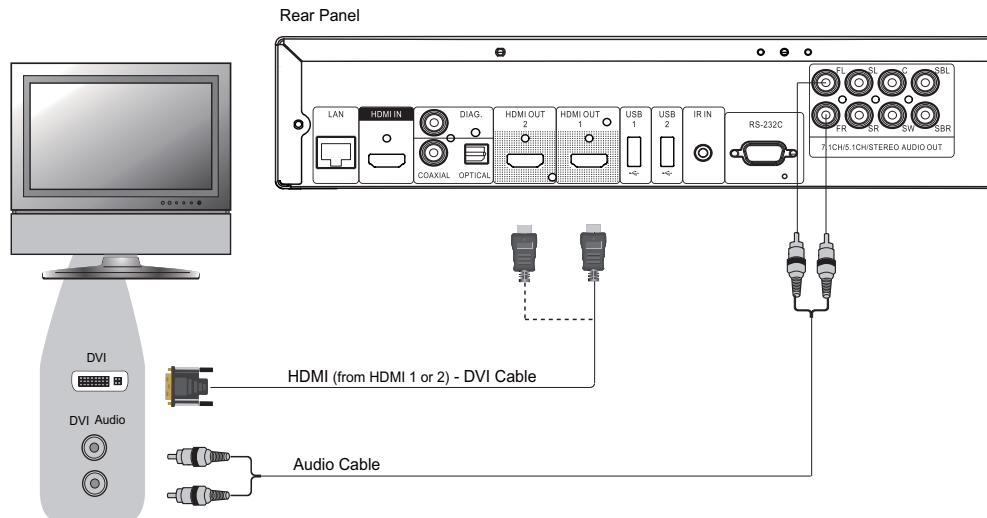

- If your TV has a DVI input that supports HDCP, you can purchase an HDMI-DVI cable to connect the player to the TV. This connection method delivers digital video to the TV without any signal degradation. We recommend that you use HDMI 1 OUT since it benefits from the dedicated video processor.
- Please use Red/White audio cables (not included) to connect the FL (Front Left) and FR (Front Right) terminals of the player to the TV. Make sure the audio cables are connected to the same input terminal group on the TV as the DVI input. Usually, the input terminals are marked as “DVI Audio” or “PC Audio”. On some TVs you may need to use an RCA-3.5mm Mini-Jack adapter cable to connect the audio.
- You may connect the DIAG (diagnostic) output to one of your TVs for troubleshooting purpose. Refer to page 13 for more details.

NOTE

HDCP stands for High-bandwidth Digital Content Protection. The HDMI outputs of the BDP-103 use HDCP to encrypt the digital audio and video content. The TV must support HDCP in order to decrypt and properly display the content.

Alternate Audio Connections

Connecting to an A/V Receiver or Amplifier via Analog Outputs

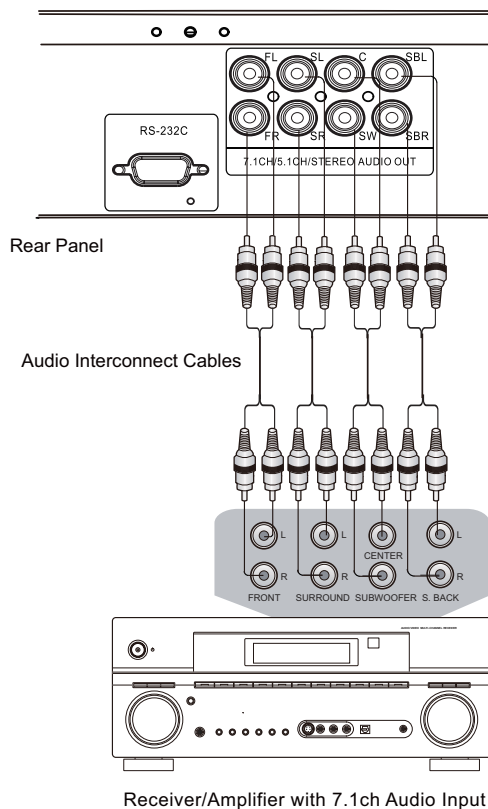

- Please use up to 8 RCA-style audio interconnect cables (not included) to connect the FL (Front Left), FR (Front Right), SL (Surround Left), SR (Surround Right), C (Center), SW (SubWoofer), SBL (Surround Back Left) and SBR (Surround Back Right) analog output terminals of the BDP-103 to the corresponding multi-channel analog audio input jacks of your A/V receiver or amplifier.
- If the A/V receiver or amplifier only has 5.1ch audio inputs, do not connect the SBL (Surround Back Left) and SBR (Surround Back Right) terminals, and set the **Down Mix** option in the **Setup Menu** to **5.1** to make sure that any 7.1 channel signals are converted to 5.1 channels (refer to **Down Mix Mode** on page 68).
- If your audio system offers only stereo audio inputs, or if you would like to connect a dedicated stereo audio system in addition to the surround audio system which is already connected to the HDMI or S/PDIF outputs, you can connect the dedicated stereo audio system to the FL (Front Left) and FR (Front Right) terminals of the player.
- For the stereo outputs, if the audio system you are connecting to does not have surround speakers, set the **Down Mix** option in the **Setup Menu** to **Stereo**. If the audio system has surround speakers and Dolby Pro Logic or other surround audio decoding capabilities, set the down mix mode to "LT/RT". (For more information, refer to "**Down Mix Mode**" on page 68).

Connecting to an A/V Receiver or Amplifier via S/PDIF (Coaxial / Optical)

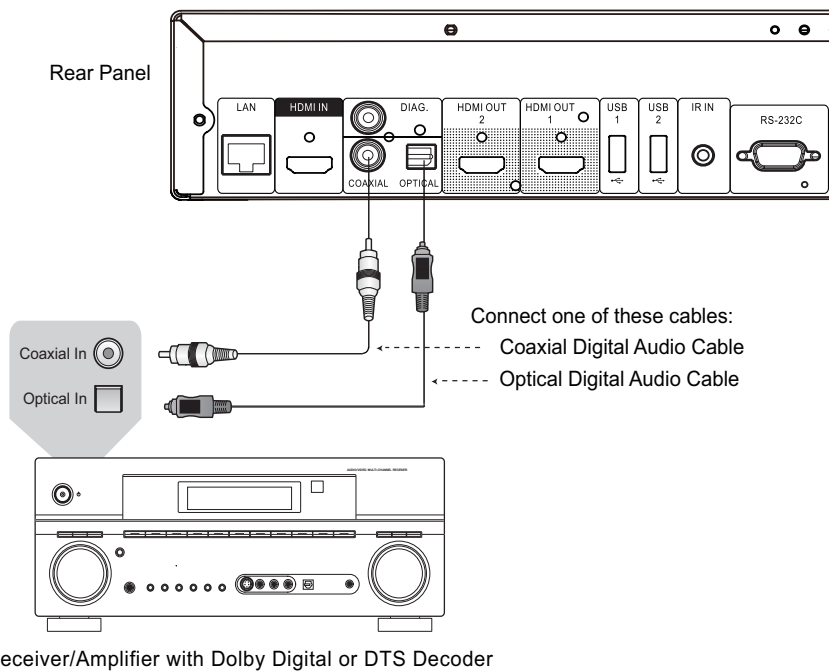

- Please use either a 75-Ohm coaxial digital audio cable with RCA-style connectors or an S/PDIF optical digital audio cable to connect one of the digital audio outputs to the corresponding input terminal on your A/V receiver. For detailed setup of coaxial/optical signals, refer to page 66.

NOTE

- Due to bandwidth limitations, high resolution audio formats such as Dolby Digital Plus, Dolby TrueHD, DTS-HD High Resolution and DTS-HD Master Audio cannot be sent through the coaxial or optical digital audio output. A reduced resolution version of the same audio track will be output instead. To listen to high resolution audio formats in their best quality, please use the HDMI connection if you have a receiver that handles HDMI audio (see page 11) or use the multi-channel analog outputs if you do not (see page 16).
- Due to copyright restrictions, SACD audio cannot be sent through the coaxial or optical digital audio output. To listen to SACDs, please use the HDMI or analog audio connections.
- Due to copyright restrictions and bandwidth limitations, full resolution audio from DVD-Audio discs cannot be sent through the coaxial or optical digital audio output. To listen to DVD-Audio in full resolution, please use the HDMI or analog audio connections.

HDMI / MHL INPUT to BDP-103

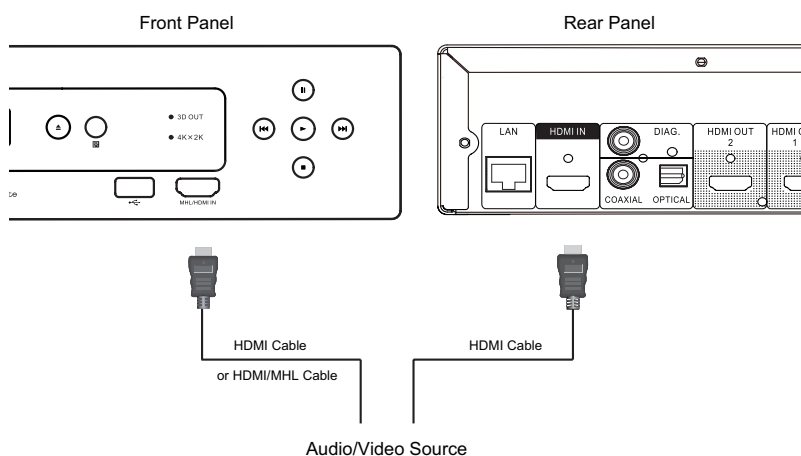

- The BDP-103 provides two HDMI input ports, located on the front panel and the back panel separately, both of which can accept up to 1080p high-definition video and digital audio. You can use the included HDMI cable to connect a source device such as a digital TV box, mobile phone or camcorder to the HDMI IN port(s). You can use the **INPUT** button on the OPPO remote to open the **Input Source Menu**, which allows you to select the corresponding HDMI IN port.
- Keep in mind that the HDMI IN port on the front panel is MHL (Mobile High-definition Link) compatible, which means if it is connected to another MHL-enabled device (like a smartphone) through a MHL cable or adaptor (not included), then this port is not only capable of accepting high-resolution digital signals, but can also simultaneously charge the connected device.

Connecting to the Internet

The BDP-103 has significantly improved its internet streaming capabilities compared to its predecessors. Currently, it supports both Netflix and VUDU, as well as in-home network media sharing via My Network which is capable of connecting with DLNA and SMB/CIFS clients. Additional online streaming applications may also be added with future firmware updates.

The BDP-103 also supports the BD-Live feature offered on some Blu-ray Disc titles. BD-Live offers extra downloadable content and additional online interactive programs. Content available on BD-Live varies by disc and studio, and may include additional subtitles, commentaries, movie trailers, games, and online chat.

Connecting the player to the Internet will also allow the player to obtain firmware updates. (See pages 4 and 73 for more information regarding firmware updates.)

In order to utilize the BD-Live feature or to update the firmware via the Internet, the player needs to be connected to a broadband Internet connection. It is not necessary to connect to the Internet if you do not intend to use the network streaming, BD-Live or online firmware update features.

The BDP-103 provides two network connection methods: through Ethernet cable or through the external wireless adaptor included with the player. For the fastest and most stable network connection, we recommend using an Ethernet cable whenever possible.

Internet connection through Ethernet cable

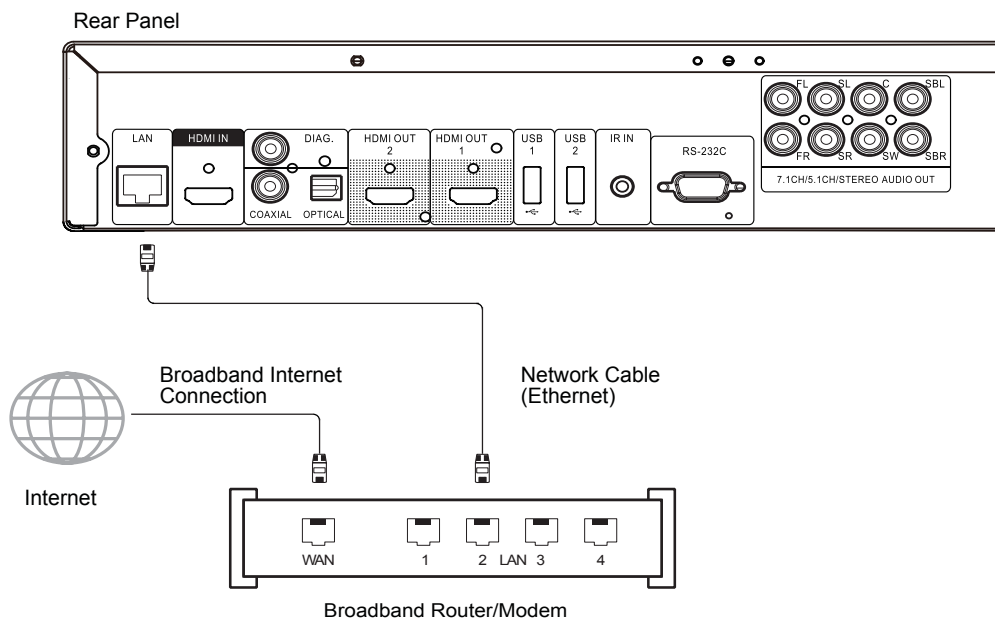

- Plug one end of a network cable (Category 5/5E straight Ethernet cable) into the LAN port on the back of the BDP-103.
- Plug the other end of the network cable into a LAN port on the broadband router or modem.
- After physically connecting the player to a broadband Internet connection, some network configuration may be required. Refer to the **Network Setup** section on page 77 for details.

INSTALLATION

- Refer to the operating instructions supplied with the broadband router or modem, or contact the Internet service provider for questions related to setting up the router or modem.

NOTE

- Only connect the LAN port of the player to an Ethernet port that supports 10BASE-T or 100BASE-TX. Connecting to any other ports or jacks, such as a phone jack, can damage the player.
- Streaming services such as Netflix and VUDU may require membership and may also be limited to service in the US only.

Internet connection through wireless adaptor

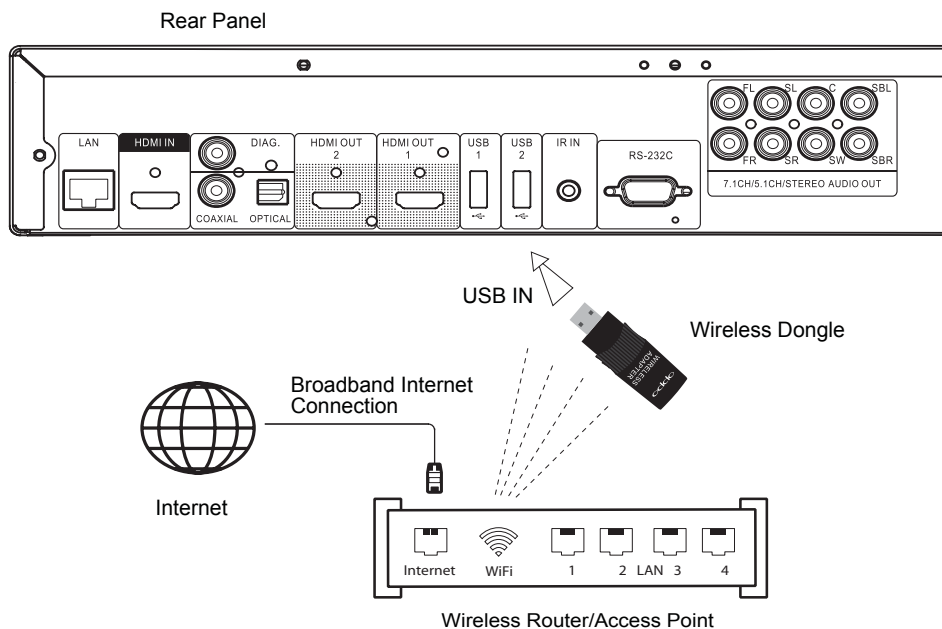

- The wireless adaptor included in the BDP-103 package has been pre-configured to work with your player. It is compatible with 802.11B, G, and N (2.4GHz) wireless networks.
- Make sure a broadband Internet connection is available and the Wi-Fi function on your wireless router or access point has been turned on, and plug the adaptor into one of the three USB ports available on your BDP-103 (one on the front panel, two on the back).
- After connecting the adaptor, some network configuration is required. Refer to the **Network Setup** section on page 77 for details.
- A USB extension cable is also included in the package. Connect it between the USB port on the player and your wireless adaptor if needed.

Custom Installation

External IR (Infrared Remote) Installation

The BDP-103 features an IR IN port on its back panel. If the player is to be installed in an equipment cabinet where direct line-of-sight is not available for the remote control, you can purchase an external IR Remote Sensor and plug it into the IR IN port. Place the sensor head at a location where there is direct line-of-sight to ensure reliable operation.

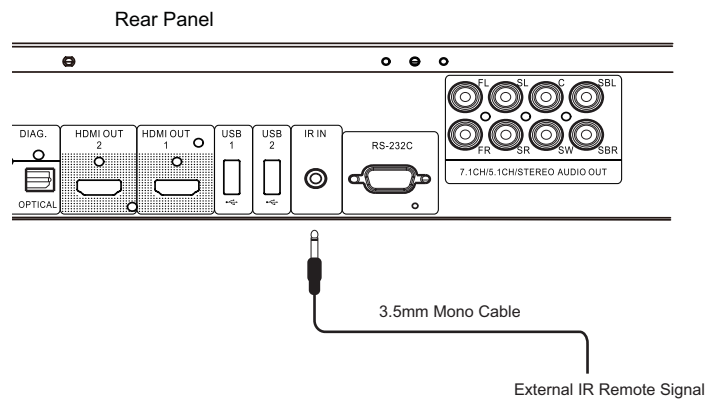

IR IN Signal Identifications

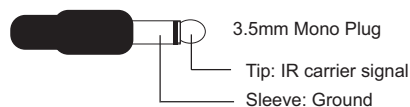

NOTE

- When an external IR sensor is plugged in, the original IR sensor window on the front panel will be disabled.
- The IR port on the BDP-103 is NOT compatible with the prior generation of external IR Remote Sensor (IR-ES1) which is used on BDP-83.
- OPPO cannot guarantee that the IR IN port will be compatible with devices that are not manufactured by OPPO. Connecting the IR IN port to an incompatible device may result in damage to the connected device or the player.
- Please contact OPPO customer support if you plan to integrate the player into an IR distribution system. Customer support can provide recommendations on how to properly connect the control signals.

RS232 Control

The BDP-103 has an RS232 control port and can be integrated into most custom home theater control systems. Please ask your custom installer to contact OPPO for the RS232 control protocol, or check the OPPO Digital website (www.oppodigital.com) for the latest version of RS-232 protocol document.

Quick Start Guide

Power On and Play

The BDP-103 is pre-configured with settings that have been optimized for most home theater systems, so it can fit into your audio/video system without any additional adjustment. To begin, please follow these steps:

1. Connect the OPPO player into your system.
2. Turn on the TV and/or receiver/amplifier, and then turn on the player.
3. Switch the input selection on your TV or receiver so that the TV displays the signal from the player.

Within a few seconds, the player will load the factory default settings and you will see the **Home Menu** with an OPPO logo. The player is now ready for use. Enjoy your new OPPO Blu-ray Disc Player!

Please follow the rest of the user manual for information on basic and advanced operations.

Select the Best Output Resolution

One of the major advantages of the BDP-103 is its ability to play high-definition Blu-ray video and also up-convert standard definition video stored on DVD discs to high definition. The sophisticated video processor inside the player ensures that the video will have the best possible color, detail and motion. The player offers several standard and high definition video output resolutions. For best results, it is important to select an output resolution that best matches your TV or display.

The rule of thumb when selecting an output resolution is to match the “native resolution” of your TV or display as closely as possible. The “native resolution” is the resolution of the actual display component in the TV, such as the Plasma panel, LCD panel, or DLP™ chip. The TV may accept input signals with lower or higher resolutions than its native resolution. In such cases, the electronics in the TV will upscale or downscale the video to fit its display component. Unfortunately, many TVs on the market only do an average job of scaling the video. On the other hand, if you set the BDP-103 to output a resolution that matches or is very close to the native resolution of the TV, you are more likely to get a great picture.

For most new displays on the market, the best output resolution will be 1080p. A few early model “1080p” displays did not accept a 1080p signal. For these displays, the best output resolution is 1080i. For small screen digital TVs this will likely be 720p. For even earlier CRT tube or rear projection TVs this will likely be 1080i. For EDTV displays (very rare if they have HDMI or DVI) this will be 480p (NTSC) or 576p (PAL). These are general recommendations that work for most users, but there can be exceptions. Advanced users may want to try all supported resolutions and choose the one that provides the best result visually.

The BDP-103 supports a special **Source Direct** mode through its HDMI outputs. This resolution is recommended for use with external video processors or high-end TVs. In **Source Direct** mode, the player works as a “transport”. It decodes video from the discs and then sends the raw video signal in its native resolution and format, without extra processing, to the external video processor or TV. The actual output resolution varies by content:

Content	Source Direct Output Resolution
NTSC DVD	480i
PAL DVD	576i
Most Blu-ray Movies (film-source)	1080p 23.976Hz or 1080p 24Hz
Most Blu-ray TV shows or Concerts (video-source)	1080i
SACD and DVD-Audio	1080p

For both HDMI outputs, the following output resolutions are available: **4Kx2K**, **Auto**, **1080p**, **1080i**, **720p**, **480p/576p**, **480i/576i**, and **Source Direct**. If **Auto** is selected, the player will determine the output resolution based on the best signal resolution that the TV can display.

To change the output resolution, press the **RESOLUTION** button on the remote to bring the **Resolution Menu**, then press the **UP/DOWN ARROW** buttons to highlight the desired one, and press the **ENTER** button to confirm and return. If your TV does not support the selected resolution, you may see a black screen or an error message. In this case, try a different resolution that your TV can support.

Determine the Display Aspect Ratio

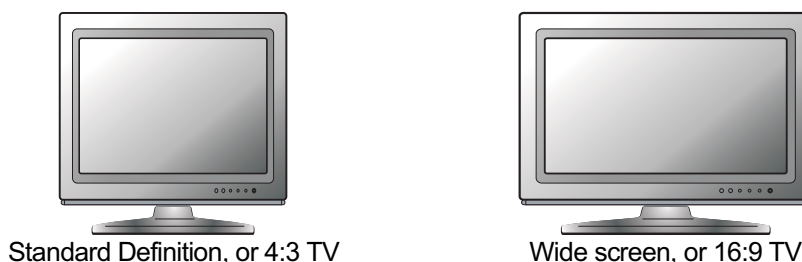

The **TV Aspect Ratio** is the proportional ratio of a TV screen's width and height. Older television sets generally have a 4:3 aspect ratio – the width is 4/3 (or 1.33) times the height. Newer wide screen television sets have a 16:9 aspect ratio – the width is 16/9 (or 1.78) times the height. For best performance, the video output of your player needs to match the screen aspect ratio of your TV. Since most Blu-ray discs and many DVD discs are released in the wide screen format, it is highly recommended to use a wide screen TV with the BDP-103.

The Aspect Ratio selections are **16:9 Wide** and **16:9 Wide/Auto**. Depending on your selection and the video format recorded on the discs, image appearance on the TV screen can be one of the following:

Original Content	TV Screen Appearance	
	16:9	
	Wide	Wide/Auto
4:3 		
16:9 		

If you have a widescreen (16:9) display, select one of these options:

- **16:9 Wide** – 16:9 (widescreen) sources will be displayed in their native aspect ratio, and 4:3 sources will be horizontally stretched.
- **16:9 Wide/Auto** – 16:9 (widescreen) as well as 4:3 sources will be displayed in their native aspect ratio. Please note that in this mode, 4:3 sources will be displayed with black borders on both left and right sides to maintain the correct 4:3 aspect ratio.

BASIC OPERATIONS

Disc Playback

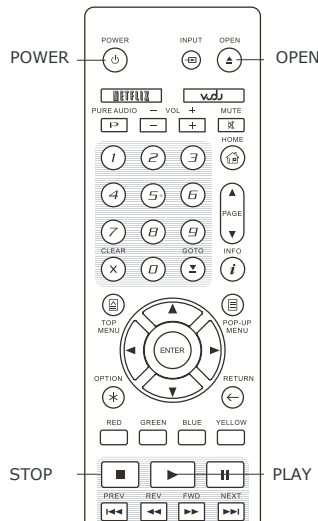

1. Press the **POWER** button to turn on the player.
2. Press the **OPEN/CLOSE** button to eject the disc tray.
3. Place the disc with the label side facing up and the recorded side facing down.

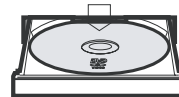

4. Press the **OPEN/CLOSE** button again to retract the tray.
5. The player will read the disc information and begin playback.
6. Depending on the content of the disc, a menu or navigation screen may appear. Use the navigation **ARROW** and **SELECT** buttons to select the content to play.
7. To stop playback, press the **STOP** button.
8. To turn off the player, press the **POWER** button.

OPTION Menu

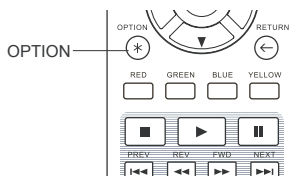

1. During media file navigation and playback, press the **OPTION** button on the remote to open the **OPTION MENU**, which allows you to conveniently access various settings and playback features.
2. When the **OPTION MENU** is displayed, press the **LEFT/RIGHT ARROW** buttons on the remote to highlight a particular item, then press the **ENTER** button to confirm.

The **OPTION MENU** selections may differ depending on content type. A summary of the selections and their functionality is described as follows:

Within Disc Playback (CD, DVD, BD):

- Disc info: Searches the Gracenote online database and display the available disc information (an active internet connection is required).

Within Music File Playback:

- Music info: As with "Disc info"; searches and displays available music information from Gracenote.
- Shuffle/Random: Activate Shuffle or Random mode. See details on page 35.
- Repeat: Repeat the track or all tracks. See details on page 34.
- Add to playlist: Add the highlighted music file to the Playlist. This function is only available when accessing external USB storage.
- Goto playlist: Access the music files added to the Playlist.
- Song Location: Return to the MUSIC interface and highlight the music file which is now playing.
- Program Play: Play the audio tracks in the preferred sequence (only available in CD playback).
- Gapless Play: Enable Gapless Playback mode. This is an experimental feature and only supports APE and WAV files stored on external USB storage.

Within Video Discs (DVD, BD) and Video File Playback:

- Subtitle Adjustment: Set the subtitle display options.
 - Color: Set subtitle text color (only available on external subtitle files).
 - Outline color: Set the outline color for subtitle text (only available on external subtitle files).
 - Size: Set subtitle text size (only available on external subtitle file).
 - Position: Set subtitle display position.
 - Sync.: Adjust the timing of the subtitles (only available on external subtitle files).
 - Defaults: Reset all subtitle options to their default values.
- Picture adjustment: Opens the Picture Adjustment menu. See details on page 56.
- Zoom: Opens the image zoom level menu. See details on page 32.
- Angle: Changes the viewing angle. This function is only available when the DVD/BD is recorded with multiple angles.

Within Photo File playback:

- Zoom: Displays the image at different zoom levels.
- Rotate – Left / Right / Mirror / Flip: Rotates the image on the screen.
- 3D: Enable 2D->3D conversion or open the 3D adjustment menu. See details on page 53.

Within HDMI INPUT playback:

- Picture adjustment: Opens the Picture Adjustment menu. See details on page 56.

Fast Playback

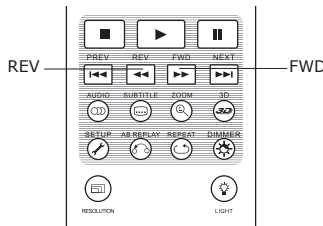

You may fast forward or reverse during playback.

1. Pressing the **FWD** button on the remote control to start fast forwarding playback. Each press of the **FWD** button increases the playback speed in the following increments:



2. Pressing the **REV** button on the remote control starts fast reverse playback. Each press of the **REV** button reverses the playback speed in the following increments:



NOTE

- Certain Blu-ray Discs utilizing BD-Java technology may have their own fast forwarding and reversing control. The actual speed varies by disc, and a progress scale may be displayed by the disc.

Pause and Frame-by-Frame

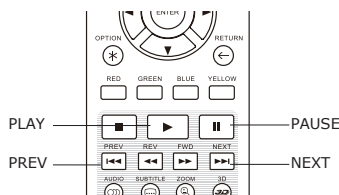

1. During playback, pressing the **PAUSE** button temporarily pauses the program. In this mode, a PAUSE icon will appear on the TV screen.
2. While a DVD or Blu-ray Disc is paused, pressing the **PREV** or **NEXT** button reverses or advances the video frame-by-frame.
3. Pressing the **PLAY** button resumes normal playback.

Slow Playback

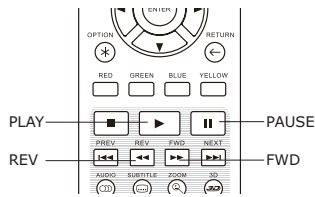

To play the video in slow-motion, follow these steps:

1. Press the **PAUSE** button on the remote control to pause playback.
2. Press the **FWD** button to select a forward slow playback speed. Each press of the **FWD** button increases the playback speed in the following increments:



3. Press the **REV** button to select a reverse slow playback speed. Each press of the **REV** button reverses the playback speed in the following increments:



4. To exit the slow playback mode, press the **PLAY** button.

NOTE

- Certain Blu-ray Discs utilizing BD-Java technology may not support slow playback.

Blu-ray Disc Menu Playback

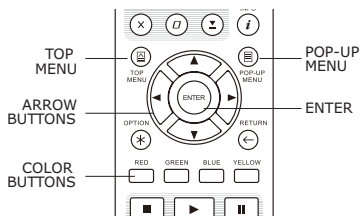

1. Blu-ray Discs usually contain a **Top Menu** and a **Pop-up Menu**. The **Top Menu** normally appears at the beginning of playback, after the previews and copyright messages. The **Pop-up Menu** can be accessed during the movie without interrupting playback.
2. During playback, press the **POP-UP MENU** button to access the **Pop-up Menu**. Press the **TOP MENU** button to access the **Top Menu**.
3. Navigate the menu using the **ARROW** buttons, and then press the **ENTER** button to make a selection.
4. Some menus make use of the **COLOR** buttons. You can select menu functions by pressing the corresponding **COLOR** button on the remote control.

DVD Menu Playback

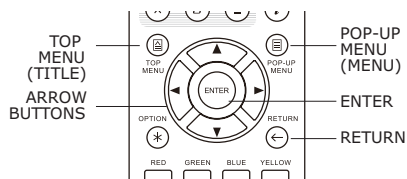

1. Some DVDs contain title menu or chapter menu functions.
2. During playback, press the **TOP MENU** button to return to the disc title menu. Press the **POP-UP MENU** button to display the chapter menu. Depending on the disc, one or both menus may not exist.
3. Navigate the menu using the **ARROW** buttons, and then press the **ENTER** button to make the selection.
4. Press the **RETURN** button to return to the previous menu. The return location varies by disc.

On-Screen Display

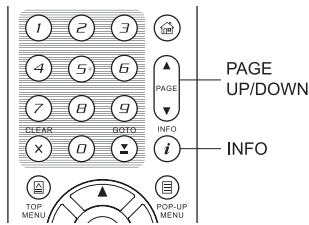

1. During the playback of a DVD or Blu-ray Disc, press the **INFO** button on the remote control to show its status information. For CDs and SACDs, the status information is shown automatically.
2. When the status information is shown, press the **PAGE UP/DOWN** buttons to scroll through several different display formats. The playback time information displayed on the front panel changes together with the on-screen display.
3. Press the **INFO** button again to hide the on-screen display. The playback time information display on the front panel will remain in the selected format.

The following display formats are available:

DVD and Blu-ray Disc:

- Title elapsed time
- Chapter elapsed time
- - Title remaining time
- - Chapter remaining time

CD and SACD:

- Track elapsed time
- Disc elapsed time
- - Track remaining time
- - Disc remaining time

In addition to the playback time, the on-screen display may also contain the following information about the content currently playing:

- Playback status: an icon indicating play, pause, and fast forward/reverse status.
- Bit rate meter: an indication of the bit rate of the audio and video stream.
- Current and total title numbers. (DVD and Blu-ray Discs)
- Current and total chapter numbers of the current title. (DVD and Blu-ray Discs)
- Current and total tracks. (CDs and SACDs)
- Audio information: current and total available number of audio tracks, language, format, and channels.
- Subtitle information: current and total available number of subtitle tracks and language.
- Video format information: encoding type, frame rate and original aspect ratio.
- HDMI output information: connection status, video resolution, frame rate, color space, audio format and channels.

Volume Control

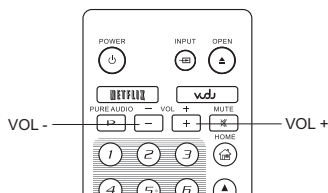

1. On the BDP-103, the volume control only affects the analog audio output. It does not apply to digital audio output (HDMI, Coaxial and Optical) either in bitstream format or in LPCM format.
2. The **VOL +/-** buttons on the player remote control are provided as an alternative way of controlling the audio volume. It is recommended that you use this control to make the audio volume from the player the same as from other sources, such as TV programs or a VCR.
 - Press the **VOL -** button to decrease the volume.
 - Press the **VOL +** button to increase the volume.

Mute

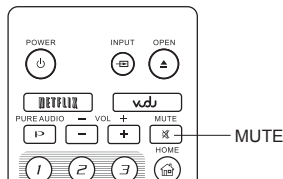

1. Press the **MUTE** button on the remote control during content playback to turn off audio output. The TV screen displays a mute icon. The front panel MUTE indicator will also light up.
2. Press the **MUTE** button again to resume audio output.

NOTE

Check the MUTE status on the front panel display of the player when there is no audio output. You may also press the **MUTE** button to verify the MUTE status.

Audio Language/Track Selection

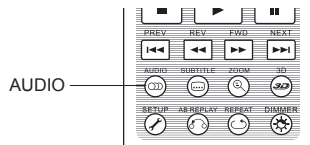

1. To select the audio language or track, press the **AUDIO** button on the remote control during playback.
2. Repeat pressing the **AUDIO** button or use the **UP/DOWN ARROW** buttons to choose from all available language or audio tracks.

NOTE

Availability of languages and audio channels varies by disc. Some DVD-Audio discs allow audio track selection with the **AUDIO** button, while others require the user to choose from the audio setup menu of the disc. When playing an SACD with both multi-channel and stereo contents, the **AUDIO** button can be used to switch between the two formats.

Subtitle Selection

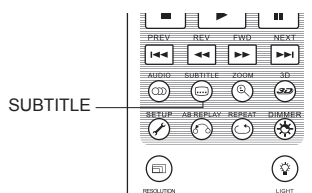

1. When playing a DVD, Blu-ray Disc or other video programs recorded with subtitles, press the **SUBTITLE** button on the remote control to select the desired subtitle.
2. Repeatedly press the **SUBTITLE** button or use the **UP/DOWN ARROW** buttons to choose from all available subtitles.
3. To turn off subtitles, select **Off** from the list.

HDMI / MHL INPUT Selection

Input
BLU-RAY PLAYER
● HDMI/MHL IN-FRONT
HDMI IN-BACK
ARC: HDMI OUT 1
ARC: HDMI OUT 2

1. When sending external media sources to the BDP-103 through the front and back HDMI IN ports, press the **INPUT** button on the remote to bring the “Input Source” menu.
2. Use the **UP/DOWN ARROW** buttons to choose the required HDMI input port.
3. You can always select the **BLU-RAY PLAYER** to return to OPPO HOME menu.

NOTE

The front HDMI IN port is MHL (Mobile High-definition Link) compatible. Please refer to page 18 for more details. A dedicated MHL cable or adapter is required (not included) and some configuration may be required on the mobile device.

Audio Return Channel (ARC) Selection

Input
BLU-RAY PLAYER
HDMI/MHL IN-FRONT
HDMI IN-BACK
● ARC: HDMI OUT 1
ARC: HDMI OUT 2

1. When sending a digital audio signal from the TV back to the BDP-103 through an HDMI connection, press the **INPUT** button on the remote to bring the **Input Source** menu.
2. Use the **UP/DOWN ARROW** buttons to choose the required ARC channel.
3. You can always select **BLU-RAY PLAYER** to return to OPPO HOME menu.

NOTE

- Audio Return Channel (ARC) is a feature introduced in HDMI v1.4, which allows you to send digital audio signals from the television back to the player or receiver. Instead of listening through TV speakers, ARC allows the sound to be processed and produced by the home theater audio system.
- A HDMI 1.4 cable is required (included) and you need to make sure the HDMI input port on the TV is ARC capable. Usually, ARC has to be enabled in the TV’s settings.

BD-Live



 Some Blu-ray Disc titles are released with the BD-Live feature. BD-Live offers extra downloadable content and additional online interactive programs. BD-Live content varies by disc and studio, and may include additional subtitles, commentaries, preview trailers, games, and online chat. A Broadband internet connection is required to enjoy BD-Live content (see page 19).

Depending on how the studios organize their BD-Live content, some Blu-ray Discs may start downloading BD-Live content when playback starts, have a BD-Live selection on the main menu, show a prompt asking whether you would like to start downloading, or ask you to sign up for a membership or account. Please follow the instructions that come with the disc to enjoy BD-Live contents.

Your Internet connection speed and the capacity of the BD-Live content servers can all affect how fast BD-Live content is downloaded. If you encounter slow downloading or intermittent playback, please play the disc without accessing the BD-Live features, or try again at a different time.

When you use the BD-Live feature, the player or disc ID and your IP (Internet Protocol) address may be sent to the content provider via the Internet. Generally, no personally identifiable information is sent. However technologies exist to match your IP address to a certain geographical area or service provider. Your Internet service provider also has the knowledge of who is using a particular IP address. If the BD-Live content provider requires you to log in using a membership or account, the content provider will have access to your membership or account information. Check with your Internet service provider and the BD-Live content providers for their privacy policy.

You can choose to restrict **BD-Live Network Access** in the **Setup Menu** (details on page 77).

ADVANCED OPERATIONS

Output Resolution

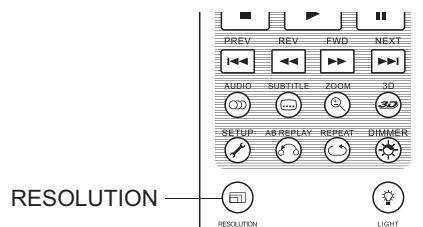

The BDP-103 supports multiple output resolutions. For a detailed discussion on how to choose the best output resolution, please refer to the **Select the Best Output Resolution** section on page 22 of this manual.

If you would like to change the output resolution, you may do so by pressing the **RESOLUTION** button on the remote.

1. Make sure the HDMI cable is properly connected.
2. Turn on the TV and adjust the TV to use its HDMI input port.
3. Make sure that the player is turned on. Although the output resolution can be changed while a disc is playing, it is recommended that you stop playback and take out the disc before changing the output resolution. Press the **RESOLUTION** button. The **Resolution Menu** appears on the TV screen. If the TV does not support the current resolution and you cannot see the **Resolution Menu**, the current resolution is also displayed on the player's front panel.
4. Use the **UP/DOWN ARROW** buttons to select the new output resolution. You may also press the **RESOLUTION** button multiple times to cycle through the available output resolutions.
5. Press the **ENTER** button to apply the selected output resolution. If you do not want to change the output resolution, press the **RETURN** button to exit and return.

The following output resolutions are available:

NTSC output:

4Kx2K → Auto → 1080p(60Hz/24Hz) → 1080i 60Hz → 720p 60Hz → 480p → 480i → Source Direct

PAL output:

4Kx2K → Auto → 1080p(50Hz/24Hz) → 1080i 50Hz → 720p 50Hz → 576p → 576i → Source Direct

NOTE

- Some TV sets may not support one or more output resolutions. If an incompatible output resolution is selected, you will get a blank screen or an error message. If this occurs, please select an output resolution that is supported by the TV.
- If you cannot get a picture using HDMI, please remove the HDMI cable and connect the player's DIAG (diagnostic) output to the TV using a regular composite video cable, and then use the **Setup Menu** to adjust the player settings.
- Due to the "Analog Sunset" provision, as of January 1, 2011 all Blu-ray Disc players made and sold going forward will not be able to pass high definition video (720p, 1080i, or 1080p) via Component Video outputs. Because of this, we have removed the Component and

Composite video outputs on the BDP-103, and only kept a standard definition DIAG video output for troubleshooting purposes.

Zooming and Aspect Ratio Control

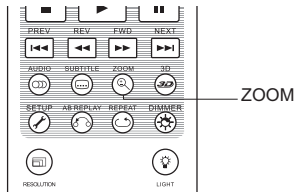

This feature zooms in and out of the displayed frame and also changes the aspect ratio (image width vs. height).

To change the zoom level, press the **ZOOM** button on the remote control. Each press of the **ZOOM** button will switch the zoom level in sequence.

Zoom Levels for HDMI Output

The available zoom levels depend on the **TV Aspect Ratio** setting in the **Setup Menu** and the encoded aspect ratio on the BD/DVD Disc:

1:1 (No zoom), Stretch/Compress, Full Screen, Under Scan, 1.2X, 1.3X, 1.5X, 2X, 1/2X

The zoom level is reset to 1:1 when the disc is ejected, or when the player is turned off.

The following zoom levels may be useful for specific applications:

- 1) Playing 16:9 BD or DVD when **TV Aspect Ratio** is set to **16:9 Wide** or **16:9 Wide/Auto**
 - **Stretch** – The image is vertically stretched 1.33 times. For movies with 2.35:1 aspect ratio, this zoom level cuts off the black borders at the top and bottom of the image. Users of a projector with an anamorphic lens may find this mode helpful.

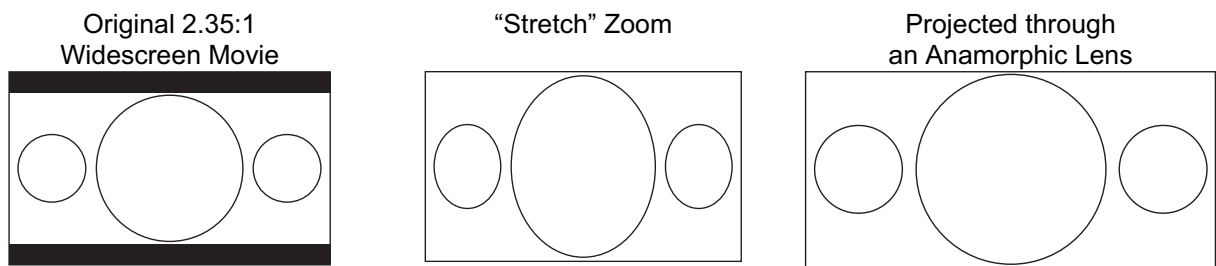

- **Full Screen** – The image is stretched by 1.33 times for both vertical and horizontal directions. For movies with 2.35:1 aspect ratio, this zoom level cuts off the black borders at the top and bottom of the image while maintaining the correct aspect ratio. The left/right sides of the image are slightly cropped.

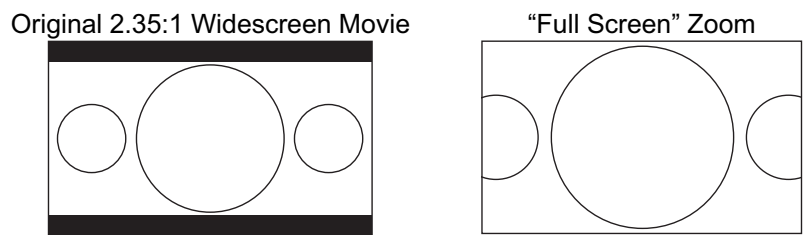

ADVANCED OPERATIONS

2) Playing 4:3 BD or DVD when **TV Aspect Ratio** is set to **16:9 Wide**

- **1:1** – The image fills up the entire 16:9 screen but is horizontally stretched. Figures may look shorter and wider than they should be.
- **Compress** – The player maintains the correct 4:3 aspect ratio and adds borders to the left and right sides of the image.
- **Full Screen** – This zoom level maintains the correct aspect ratio but crops the top and bottom slightly in order to fit the 4:3 image to the 16:9 screen.

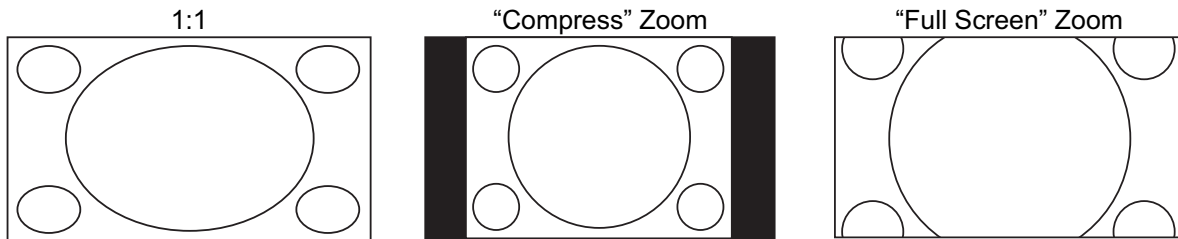

3) Playing 4:3 BD or DVD when **TV Aspect Ratio** is set to **16:9 Wide/Auto**

- **1:1** – The player maintains the correct 4:3 aspect ratio and adds borders to the left and right sides of the image.
- **Stretch** – The image is horizontally stretched 1.33 times. This zoom level fills up the 16:9 screen, but figures may look shorter and wider than they should be.
- **Full Screen** – This zoom level maintains the correct aspect ratio but crops the top and bottom slightly in order to fit the 4:3 image to the 16:9 screen.

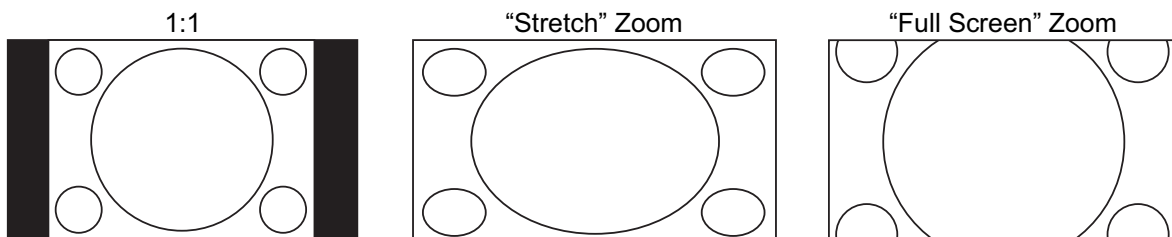

The “Under Scan” zoom level shrinks the image by 5%. This zoom level may be used to compensate for TVs that over scan, so the viewer can see the entire image area with no cropping. All other zoom levels are indicated by their respective zoom ratio.

NOTE

- Some early DVD titles (released from 1997 until early 2000’s) use a 4:3 non-anamorphic widescreen aspect ratio. When played on a 16:9 display, the content is shown in a small window with black borders on all four sides. The top and bottom borders are encoded into the video. The left and right borders are added by the player to maintain the correct aspect ratio. For these types of discs, the **Full Screen** zoom mode can be used to eliminate the borders.
- The ZOOM feature may not be available when certain DVD or Blu-ray Discs are played if the disc’s author has chosen to disable ZOOM.

Subtitle Shift

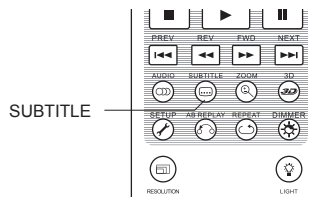

For customers using a 2.35:1 “Constant Image Height” video projection system, subtitles may get cut off because they are positioned outside of the active video area.

The Subtitle Shift feature can be used to shift subtitles up or down so they are displayed within the active video area.

To shift the display position of subtitles, please follow these steps:

1. When playing a DVD, Blu-ray Disc or other video programs recorded with subtitles, select the desired subtitle from the disc menu or by using the remote. (Refer to page 28 for more information.)
2. Press and hold the **SUBTITLE** button on the remote control until the **Shift Subtitle Position** prompt appears on the screen.
3. Wait until subtitle text is shown on the screen, and then use the **UP/DOWN ARROW** buttons to move the subtitle text to the desired position.
4. Press the **ENTER** button to set the subtitle display position.

Once the **Subtitle Shift** position is set, it is saved by the player in the **Video Setup > Display Options > Subtitle Shift** setup menu option. The setting will be applied to subtitles of all future DVD and Blu-ray Discs. You can also change the setup menu item directly. Refer to the **Video Setup** section beginning on page 53 for more information.

Repeat Playback

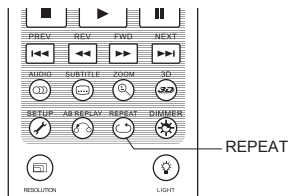

To repeat a certain chapter, title, track or disc, press the **REPEAT** button on the remote control.

Each press of the **REPEAT** button changes the repeat mode using the following sequence:

DVD and DVD-Audio:



Blu-ray Disc:



CD and SACD:



NOTE

- Certain Blu-ray Discs may not allow for repeating.

Repeat a Selected Section

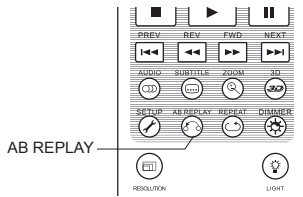

To repeatedly play a specific section, please follow these steps:

1. During normal playback, press the **AB REPLAY** button on the remote at the desired beginning point (Point A) for the repeat play. The TV screen displays "A-".
2. When playback reaches the desired ending point (Point B) for the repeat play, press the **AB REPLAY** button again. The player now repeatedly plays back the specified section (A-B). The TV screen displays "A-B".
3. Press the **AB REPLAY** button for the third time to resume normal playback.

NOTE

- Not available for all disc formats or content. Certain Blu-ray Discs may not allow for repeating.
- If pressing the AB REPLAY button twice within 1 second, video playback will be automatically rewind 10 seconds.

Shuffle and Random Playback

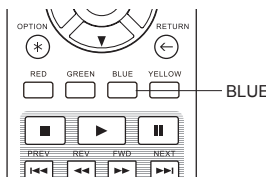

When playing a CD or SACD, press the **BLUE** button on the remote control to activate the **Shuffle** and **Random** modes. Each press of the **BLUE** button switches the playback mode in the following sequence:



In normal playback mode, each track is played back in sequential order. As the name implies, the **Random** playback mode randomly selects a track to play. The **Shuffle** mode also plays back the tracks in random order, but it ensures that each track is played only once.

Selecting the **Shuffle** or **Random** mode cancels any **Repeat** mode you may be using. Similarly, selecting a **Repeat** mode cancels any **Shuffle** or **Random** mode.

Playback by Chapter or Track Number

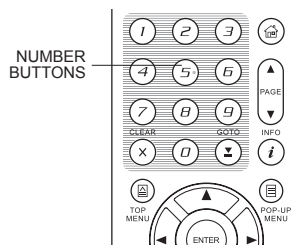

During the playback of a disc, you can use the **NUMBER** buttons on the remote control to directly jump to a specified chapter or track number. For example:

- To select the seventh track, press the **[7]** button.



- To select the 16th track, press **[1]** followed by **[6]** in quick succession:

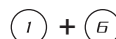

NOTE

- Certain DVD-Audio and Blu-ray Discs may not allow for direct chapter selection.

Playback from a Specific Location



DVD and Blu-ray Discs

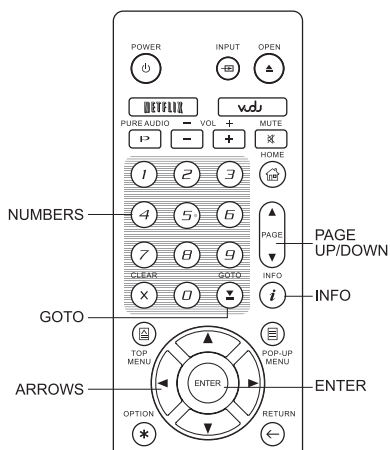

During the playback of a DVD or Blu-ray Disc, you may specify a location to start playback by entering the title, chapter or time directly. Press the **GOTO** button to bring up the on-screen display.

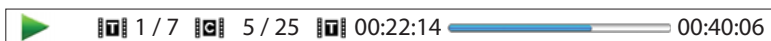

On top of the video screen, the on-screen display information has the following components (from left to right): Playing Status, Title, Chapter, Time Counter, Progress Indicator, and Total Time. After pressing the **GOTO** button for the first time, the cursor will be positioned at the Time Counter. This is the **Time Search** mode. Each subsequent press of the **GOTO** button will switch the search mode in the following sequence:

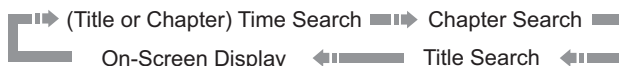

1. **Title time search.** Searches for a specific time within the currently playing title.

- Press the **GOTO** button to bring up the on-screen display. The cursor will be positioned at the Time Counter. Use the **NUMBER** or **ARROW** buttons to enter the hours, minutes and seconds for your specific search and press the **ENTER** button.



2. **Chapter time search.** Searches for a specific time within the currently playing chapter.

- Press the **INFO** button to bring up the on-screen display. Use the **PAGE UP** or **PAGE DOWN** button to switch the display to Chapter Time mode (note the icon placed on the left of the Time Counter changes from the Title icon to the Chapter icon). Press the **GOTO** button to position the cursor at the Time Counter, then use the **NUMBER** or **ARROW** buttons to enter the hours, minutes and seconds for your specified search and press the **ENTER** button.



3. **Chapter search.** Allows you to search for a particular chapter.

- Repeatedly press the **GOTO** button until the cursor is positioned at the Chapter location. Use the **NUMBER** or **ARROW** buttons to enter or select the chapter number and press the **ENTER** button.

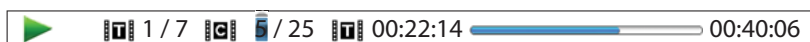

4. **Title search.** Allows you to search for a particular title.

- Repeatedly press the **GOTO** button until the cursor is positioned at the Title location. Use the **NUMBER** or **ARROW** buttons to enter or select the title number and press the **ENTER** button.

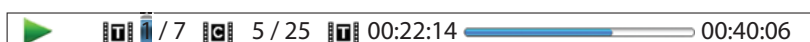

NOTE

- Some discs may prohibit the search operation. You will not be able to select a search location, or you may get an “invalid operation” icon after specifying a search location.
- Some Blu-ray Discs feature their own search function. Follow the on-screen instructions to use the search function provided by such discs.

CD and SACD Discs

You may specify a point to start playback by entering the disc elapsed time, track elapsed time or track number directly. When playing CDs and SACDs, the on-screen display automatically shows on the TV screen:

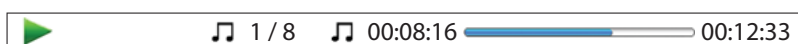

The on-screen display has the following components (from left to right): Playing Status, Track Number, Time Counter, Progress Indicator, and Total Time.

To specify a playback location using one of the following search modes, press the **GOTO** button. Each press of the **GOTO** button switches the search mode in the following sequence:

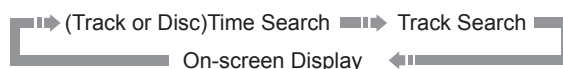

1. **Track time search.** Searches for a specific time within the currently playing track.
 - Press the **GOTO** button to place the cursor on the track Time Counter. Use the **NUMBER** or **ARROW** buttons to enter the hours, minutes and seconds for your specified search and press the **ENTER** button.



2. **Disc time search.** Navigates you to a particular timestamp.
 - While the on-screen display is shown, press the **PAGE UP** or **PAGE DOWN** button to switch the Time Counter to Disc Time mode. Press the **GOTO** button to place the cursor at the Disc Time Counter. Use the **NUMBER** or **ARROW** buttons to enter the hours, minutes and seconds for your specified search and press the **ENTER** button.



3. **Select a track.** To navigate to a particular track:
 - Repeatedly press the **GOTO** button until the cursor is placed on the Track Number position. Use the **NUMBER** or **ARROW** buttons to enter or select the track number and press the **ENTER** button.

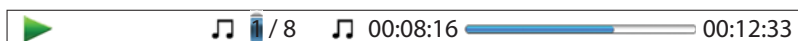

Memory and Automatic Resume

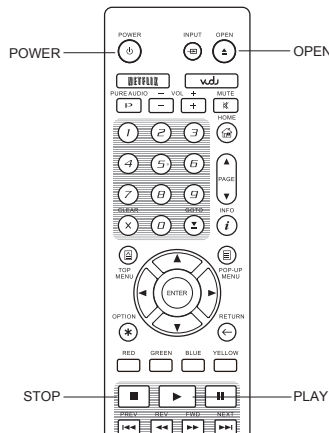

1. The player automatically saves the current position when playback is interrupted. Operations such as **OPEN** and **POWER** cause the player to save the current playing position.
2. This position is saved even after turning off the unit or changing the disc.
3. The next time a disc with a saved playing position is inserted, the player will resume playback from that point. If you wish to cancel the automatic resume and start playback from the beginning, you must press the **STOP** button when prompted.
4. The player can save the playback position for up to 5 discs. When the position from the sixth disc is saved, the oldest saved position is replaced.

NOTE

- Some Blu-ray Discs do not support resuming and will always play from the beginning.

Viewing Pictures on DVD-Audio Discs

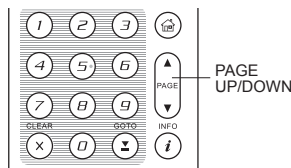

Some DVD-Audio discs contain static pictures, such as photos of the band as well as album narration. When a DVD-Audio track is playing, you may use the **PAGE UP** button to select the previous picture or the **PAGE DOWN** button to select the next picture.

NOTE

- Availability of static pictures depends on the DVD-Audio disc.

Pure Audio Mode

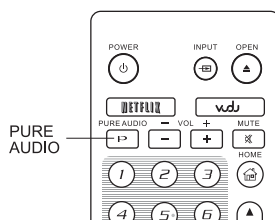

You can enjoy higher quality audio by turning off the video processing and output. The **Pure Audio** mode reduces any potential interference between the video and audio signals.

1. Press the **PURE AUDIO** button on the remote control to turn off video and enter **Pure Audio** mode. Video output will cease, the power light will dim and the front panel displays will turn off.
2. Press the **PURE AUDIO** button again to resume video and cancel **Pure Audio** mode.

NOTE

- **Pure Audio** mode is automatically canceled when the unit is switched off or when playback is stopped.

ADVANCED OPERATIONS

Because HDMI carries audio together with video, the HDMI video signal cannot be completely turned off. A black screen is transmitted instead to minimize any potential interference.

MEDIA FILE PLAYBACK

In addition to playing standard disc-based formats such as Blu-ray, DVD, CD and SACD, the BDP-103 can play media files. You can enjoy digital music, movies and photos stored on a data disc (recordable CD, DVD or Blu-ray) or an external USB drive. Due to the variation of media, encoding software and techniques used, compatibility cannot be guaranteed for all user-created or downloaded content. Support for such content is on a best effort basis.

Playback from USB Flash Drive

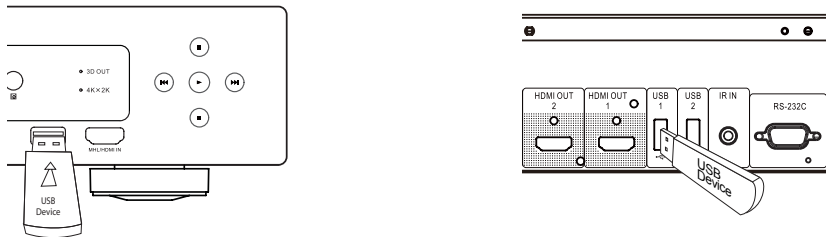

The BDP-103 is equipped with three USB ports: one on the front panel and two on the back. You may use any of the available USB ports to plug in a USB drive.

The USB ports are rated to provide a maximum of 5V, 1000mA power to the USB drive. It is sufficient for USB thumb drives and flash memory card readers, but may not be sufficient for USB hard disks. It is recommended to check with your drive manufacturer for power requirements, or use an external power supply.

NOTE

- This unit supports “USB Mass Storage Class Bulk-Only Transport” devices only. Most USB thumb drives, portable hard disk drives and card readers conform to this device class. Other USB devices such as MP3 players, digital cameras, and mobile phones may not be compatible.
- Supported USB drives can be formatted with the FAT (File Allocation Table), FAT32 or NTFS (New Technology File System) file system.
- In some cases, an incompatible USB device may cause the player to stop responding. If this occurs, simply turn off the power, remove the USB device, and turn the player back on.
- To improve user experience in media file navigation, the player may cache some of the media information on the USB drive (details on page 75). To prevent the player from writing anything to the USB drive, you can turn this option off. However, we recommend keep this option on and do not delete the cached media data.

In-home Network Media Sharing

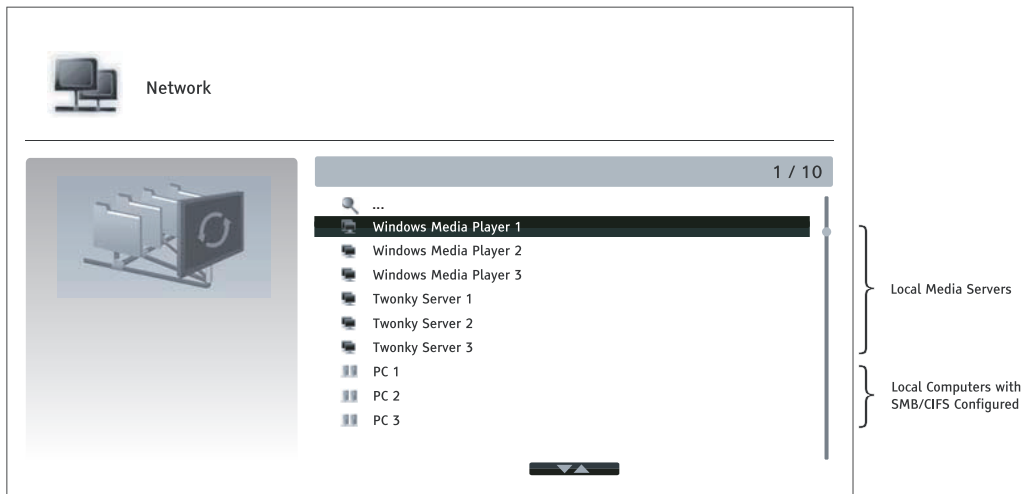

The BDP-103 can remotely play back music, photo, and video files stored on media devices that are connected to the same home network. You will need to prepare hardware such as a computer or NAS (Network Attached Storage) and install and configure software which is functionally equivalent to DLNA or SMB/CIFS (a network file sharing protocol) client. Set the **My Network** selection to **On** in the **Setup Menu** (details on page 77), press the **HOME** button on the remote to bring the **Home Menu**, select the **Network** icon and press **ENTER** button to show the list of available servers. In some case, you might need to disable the firewall on the hardware to allow BDP-103 to see the server.

The BDP-103 player can perform network sharing in one of the following three ways:

- As a digital media player (DMP): the player can actively search, access and pull content from local media servers which is functionally equivalent to DLNA.
- As a digital media renderer (DMR): the player plays content received (“pushed”) from a digital media controller (DMC). A DMC-capable media server is required. Refer to the server’s respective user instructions for correct configuration and operation.
- Accessing a SMB/CIFS client: the player can directly access files shared through SMB/CIFS clients over the network, as if accessing an external USB hard drive. Most computers, especially those installed with Windows, already have an SMB client embedded. Please refer to respective OS instructions to set up the SMB/CIFS shared file/folder.

NOTE

- NAS is a networked appliance that provides file-based data storage services to other devices on the network. Commercial products are available on the market.
- SMB (Server Message Block) or CIFS (Common Internet File System) is mostly known as Microsoft Windows Network. It does not require an extra media server or perform any media format transcoding, which reduces the processing load and keeps the original content quality.
- Compatibility with local network sharing hardware/software is on a best effort basis with no guarantee, due to variations in NAS devices, media servers and their configurations.

Internet Streaming on HOME Menu

The BDP-103 presents a **Home Menu** to assist you in navigating and playing media files from an inserted optical disc, USB flash drive, external hard drive, home network sharing and internet streaming. Basically, the **Home Menu** is the starting point for accessing media files.

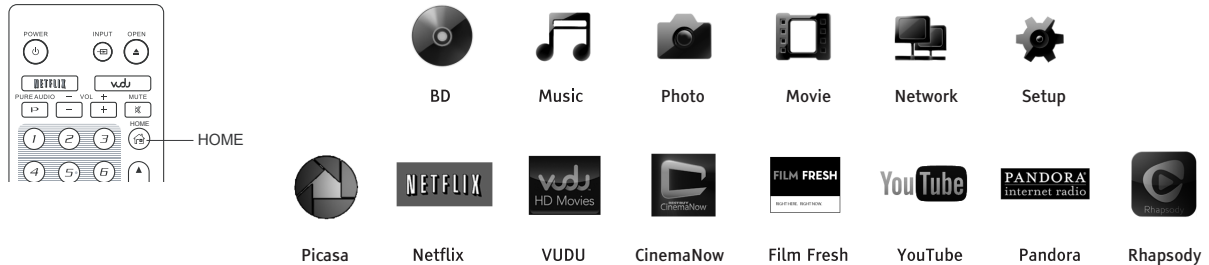

You can bring up the **Home Menu** with the **HOME** button on the remote control. Currently there are fourteen selections:

- **Disc** enables the player to start playback of an inserted optical disc.
- **Music**, **Movie** and **Photo** allow you to access corresponding type of media files from a connected USB drive and inserted data disc.
- **Network** enables the player to stream audio, video and photos from media servers on the home network. Capable hardware and software may be required.
- **Setup** brings the player's **Setup Menu**, just like pressing the **SETUP** button on the remote.
- **Netflix** connects you to your Netflix account and provides online movie streaming capabilities.
- **VUDU** connects you to your VUDU HD Movies account and provides online movie and TV Show rental, purchasing and streaming capabilities.
- **CinemaNow** connects you to your CinemaNow account and provides online movie and TV episode rental, purchasing and streaming capabilities.
- **Film Fresh** connects you to your Film Fresh account and provides online movie and TV Show rental, purchasing and streaming capabilities.
- **YouTube** provides an uninterrupted stream of HD videos from YouTube as though you were watching a normal television channel.
- **Pandora** connects you to your Pandora account and provides personalized internet radio services.
- **Rhapsody** connects you to your Rhapsody account and provides personalized internet music services.
- **Picasa** connects you to your Picasa account and provides online photo viewing and sharing capabilities.

NOTE

- The **Network** feature is not officially supported due to the variation in hardware and software configurations. OPPO does not offer technical support via email or phone for this feature. The OPPO Wiki located at wiki.oppodigital.com can be a useful resource to learn about this feature.
- Different internet streaming applications may have different function mappings on the BDP-103 remote control. To exit Netflix, YouTube or Rhapsody, press **HOME** button. To exit VUDU, Film Fresh or Picasa, either press **HOME** button or repeatedly press **RETURN** button until the **Home Menu** appears. To exit Pandora, either press **HOME** button or select **Exit Pandora** in Pandora's **Menu** selection. To exit CinemaNow, either press **HOME** button or select **Exit** in CinemaNow's **Menu** selection. Please contact OPPO customer support if you need assistance.

Playing Music Files

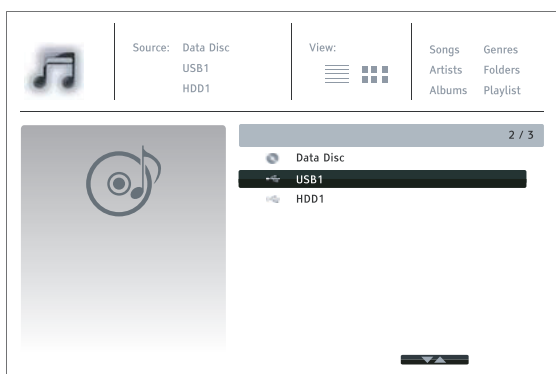

To play digital music files stored on an optical disc or USB drive, select **Music** from the **Home Menu**. A file browser will appear to assist you in navigating the files and folders.

The first step is to select the Data Disc or USB device that contains the music files. The player will take a moment to read the media and list the folders and music files.

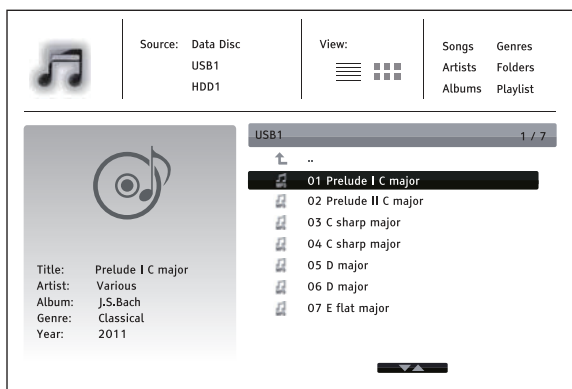

In the music browser, you can perform the following operations:

- Press the **UP/DOWN ARROW** or **PAGE UP/DOWN** buttons to move the cursor and select music files.
- Press the **OPTION** button to gain access to features such as music information. Details can be found on page 24.

- Press the **TOP MENU** button to move the cursor to the category menu in the top of the screen. This menu contains the following choices:
 - **Source** – Allows you to switch between different connected storage devices.
 - **View** – Allows you to switch between List View and Folder View modes.
 - **Sort** – Lists music files/folders by different categories, such as Song name, Artist, Album and Genre.
- When a music file is highlighted by the cursor, press the **ENTER** or **PLAY** button to start playback.

NOTE

- When a data disc or USB drive is inserted, the player automatically starts to index files and build a database in the background. Depending on the number and size of files, this process could take up to several minutes. Customers can only access the Category list (Artist, Album and Genre) when the database has been built, otherwise, a warning message will appear.

If a music file starts playing and there is no other user operation, the **Now Playing** screen will appear after a few seconds. You can also get to this screen by pressing the **OPTION** button and then selecting **Now Playing**. This screen provides the following information:

- Shows playback status: Play, Pause, Track and Time.
- Display and change playback mode: Shuffle/Random, Repeat One/All.
- Music information: Displays information like album art and tags, either embedded in the original file or found online from the Gracenote database.



The following operations are available while the **Now Playing** screen is shown:

- Normal playback control: **PLAY**, **STOP**, **PAUSE**, **PREV/NEXT**, **REV**, and **FWD**
- Special playback modes: **REPEAT** and Shuffle/Random (**BLUE** color button)
- Press the **OPTION** button to access the Option menu. (More details on page 24)
- Return to the Browser without stopping the music: **RETURN**
- Stop playback and return to the Browser: Press **STOP**

Playing Movie Files

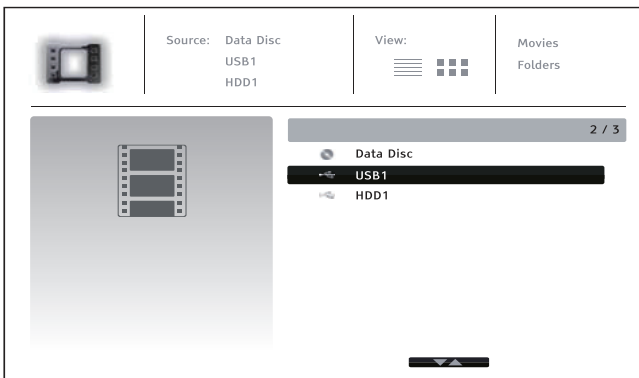

To play movie files stored on an optical disc or USB drive, select **Movie** from the **Home Menu**. A file browser will appear to assist you in navigating through the files and folders.

The first step is to select the Data Disc or USB device that contains the movie files. The player will take a moment to read the media and list the folders and movie files.

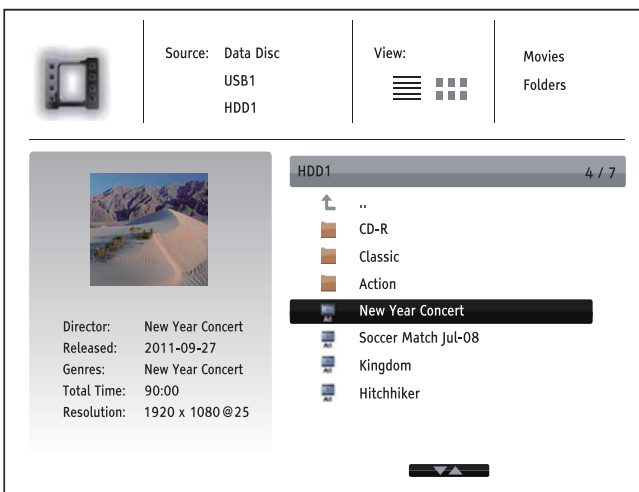

In the movie browser, you can perform the following operations:

- Press the **UP/DOWN ARROW** or **PAGE UP/DOWN** buttons to move the cursor and select movie files.
- Press the **OPTION** button to access features like video information. Details can be found on page 24.
- Press the **TOP MENU** button to move the cursor to the category menu in the top of the screen. This menu functions the same as the one discussed in *Playing Music Files* on page 43.

- When a movie file is highlighted by the cursor, press the **ENTER** or **PLAY** buttons to start playback.

Once a movie file starts playing, the normal playback control functions are available:

- To stop the movie and return to the file browser, press the **STOP** button. You can also press the **HOME** button at any time to stop the playback and return to the Home Menu.
- Press the **OPTION** button to access features such as Video Information, Subtitle Shift, Picture Adjustment and Picture Zooming. Details can be found on page 24.

Viewing Photo Files

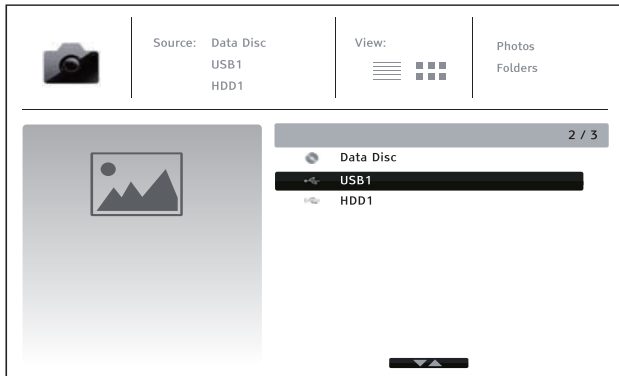

To view digital photo files stored on an optical disc or USB drive, select **Photo** from the **Home Menu**. A file browser will appear to assist you in navigate the files and folders.

The first step is to select the Data Disc or USB device that contains the photo files. The player will take a moment to read the media and list the folders and photo files.

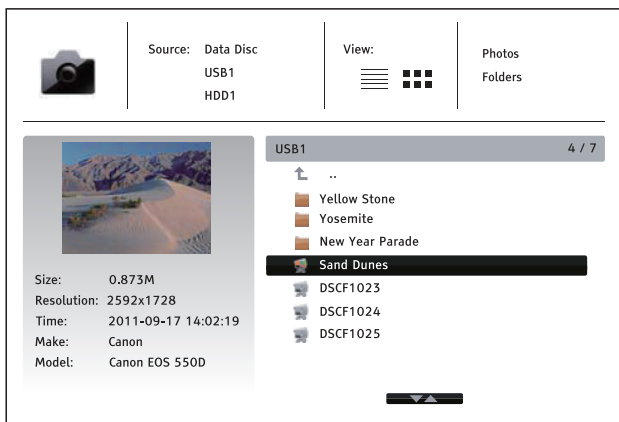

In the photo browser, you can perform the following operations:

- Press the **UP/DOWN ARROW** or **PAGE UP/DOWN** buttons to move the cursor and select photo files.
- Press the **TOP MENU** button to move the cursor to the category menu in the top of the screen.

- When a photo file is highlighted by the cursor, press the **ENTER** or **PLAY** button to play back the photos as a full screen slideshow.

The following operations are available during the photo slideshow:

- Display the help screen: **INFO**
- Normal playback controls: **PLAY**, **STOP**, **PAUSE**, and **PREV/NEXT**
- Adjust slideshow speed: **REV** and **FWD**
- Zoom: **ZOOM**. Once zoomed in, the **ARROW** buttons can be used to pan around the photo.
- Reflect (flips the photo horizontally to make it upside-down): **UP ARROW**
- Mirror (flips the photo vertically to make it a mirror image): **DOWN ARROW**
- Rotate left (counterclockwise): **LEFT ARROW**
- Rotate right (clockwise): **RIGHT ARROW**
- Repeat: **REPEAT**
- Switch between view modes: **Red** color button
- Show EXIF information: **GREEN** color button
- Play in random sequence: **BLUE** color button
- Change slideshow transition effect: **YELLOW** color button.
- Press the **OPTION** button to access to features like Image Zooming and Image Rotation. Details can be found on page 24.

Adding Background Music

You can also add background music to the photo slideshow. To do so, you will need to prepare digital music files. The music files can be stored on the same disk as the photos, or on a different USB drive. Start music playback first by selecting **Music** from the **Home Menu**. Once the music is playing, press the **HOME** button to get back to the **Home Menu**, and start the photo slideshow by selecting **Photo** in the usual manner.

SETUP MENU OPTIONS

The **Setup Menu** of the BDP-103 presents many setup and configuration options. For most users, the default configuration will be sufficient and you will not require any changes to the settings. However, if you need to configure the player to perfectly match your home theater setup and viewing preferences, please refer to the following sections for details about each configuration option.

Using the Setup Menu System

Like many other sections listed in this guide, the player's **Setup Menu** allows you to make adjustments to match your specific audio/video configuration. When performing menu adjustments, we will use the following terminology to indicate the location of the desired function:

Setup Menu Section > Menu Item > Selection

Setup Menu Section is the uppermost **Setup Menu** level. Within the BDP-103, there are six **Setup Menu** sections listed in the left column of the **Setup Menu**: **Playback Setup**, **Video Setup**, **Audio Format Setup**, **Audio Processing**, **Device Setup**, and **Network Setup**.

Menu Item is the parameter to be adjusted which appears in the center column of the **Setup Menu**. Once you enter a **Setup Menu Section**, the list of **Menu Items** and their current value are displayed in a box.

Selection is the actual numeric or descriptive element that represents the change being made to the selected parameter. It is the item located to the right of its corresponding **Menu Item**.

A **Scroll Mark** appears at the top or bottom of the menu when there are more **Menu Items** or **Selections** than what can fit in a screen. You may use the **UP** and **DOWN ARROW** buttons to scroll the display in order to access additional items.

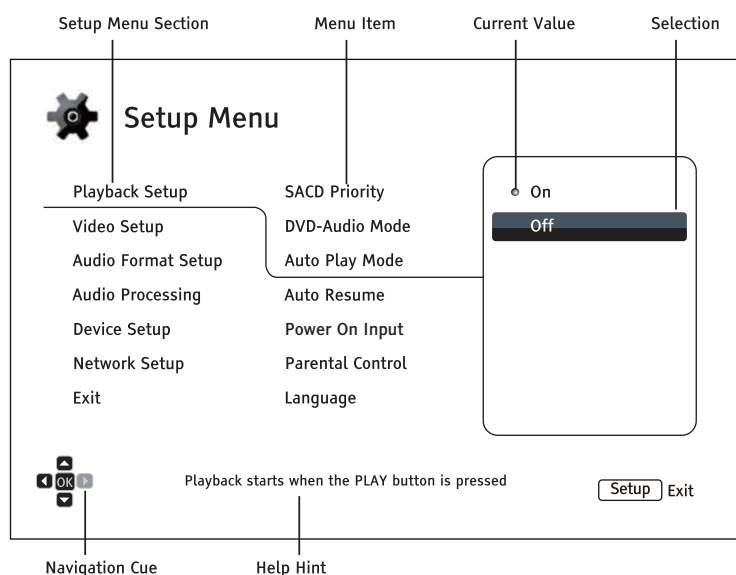

The preceding diagram should give a good description of the various elements and their context. In this screen we could, for example, instruct you to set the **Auto Play Mode** parameter to **Off** in the **Playback Setup** section. To indicate where we were, you would see the following: **Playback Setup > Auto Play Mode > Off**.

NOTE

It is possible that some setup items may be grayed-out and inaccessible. This can be caused by a disc being played back or having changed a prerequisite setup item. Please stop playback or eject the disc before trying to change these setup items. If you still cannot access the setup item, please check for configuration conflicts and consistency. For example, if **Video Setup > 3D Output** is set to **Off**, the **3D Setting** menu item will be grayed-out. Setting **3D Output** to **On (or Auto)** will enable the **3D Setting** menu.

To access the player's **Setup Menu** simply press the **SETUP** button on the remote control. Since some **Setup Menu** options can become inaccessible when a disc is being played, it is recommended that you operate the **Setup Menu** when playback is fully stopped or when there is no disc in the player.

1. Press the **SETUP** button on the remote control, and the TV screen displays the following:

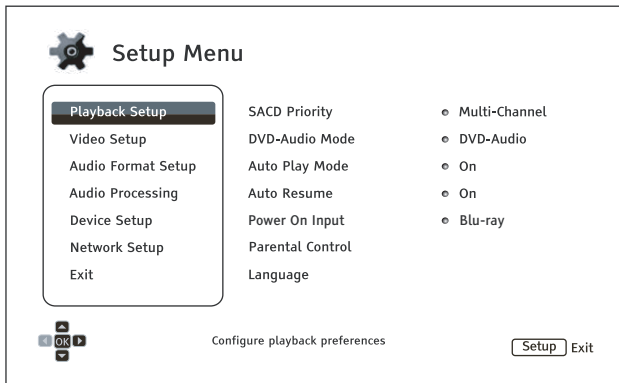

2. Press the **UP/DOWN ARROW** buttons to select the section. Press the **ENTER** button or the **RIGHT ARROW** button to enter the selected section.
3. Press the **UP/DOWN ARROW** buttons to select the setup item to be changed, and press the **ENTER** or **RIGHT ARROW** button to change the setting. When the scroll icon is shown at the top or bottom of the **Setup Menu**, it indicates that there are more menu items that can be accessed by scrolling with the **UP/DOWN ARROW** buttons.

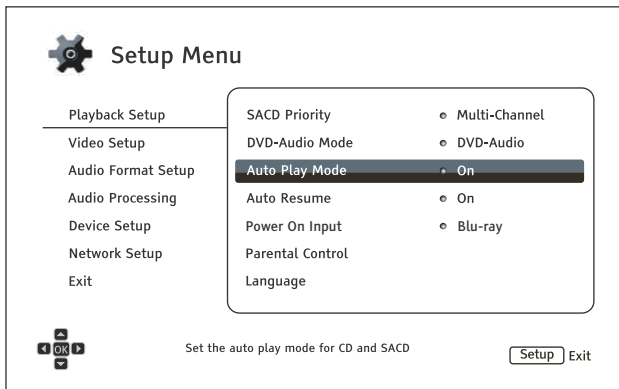

For example, in the **Playback Setup** section, you may use the **UP/DOWN ARROW** buttons to select the **Auto Play Mode** setup item, and press the **ENTER** button to change the **Auto Play Mode** setting.

SETUP MENU OPTIONS

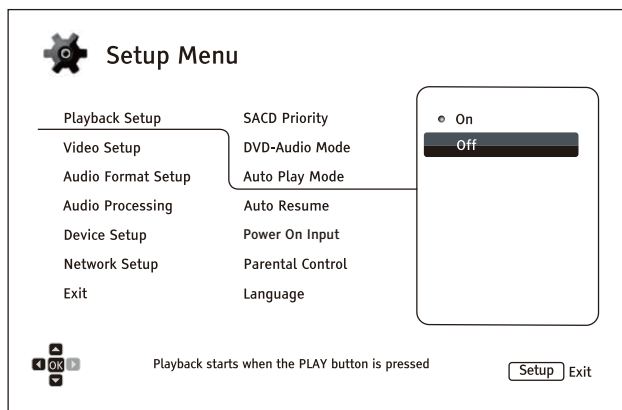

4. To select a value from the list of available settings, press the **UP/DOWN ARROW** buttons and then press the **ENTER** button to confirm.

For example, to select **Off** for **Auto Play Mode**, use the **UP/DOWN ARROW** buttons to highlight the **Off** selection and press the **ENTER** button.

5. To exit the **Setup Menu** at any time, press the **SETUP** button on the remote control or select **Exit** from the **Setup Menu** sections.

Settings are permanently saved when the player is turned off using either the front panel power button or the remote control. If the AC power is interrupted before the player enters standby, the settings will not be saved. To ensure that the settings are saved, please turn off the player and turn it back on after you make major changes to the **Setup Menu** options.

Playback Setup

The **Playback Setup** section is designed to configure playback preferences. The setup items in this section are:

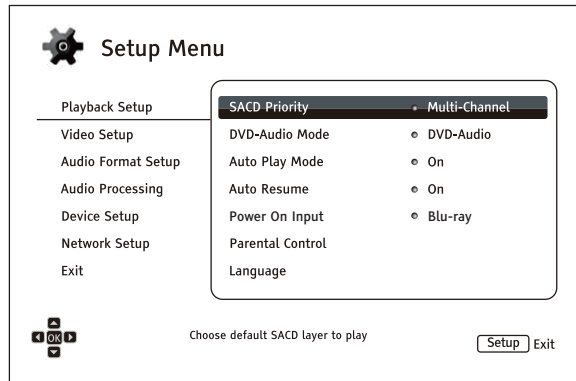

1. **SACD Priority:** Select which audio layer to play for SACD (Super Audio CD).
 - **Multi-Channel** – Play the high resolution multi-channel surround audio layer
 - **Stereo** – Play the high resolution 2-channel stereo audio layer
 - **CD Mode** – Play the CD layer of a hybrid SACD disc

2. **DVD-Audio Mode:** Select which portion of a DVD-Audio disc to play.
 - **DVD-Audio** – Play the DVD-Audio portion of the disc with high-resolution audio
 - **DVD-Video** – Play the DVD-Video portion of the disc with Dolby Digital or DTS audio

3. **Auto Play Mode:** Select whether the player will start playing a CD, SACD, DVD or Blu-ray disc automatically.
 - **On** – The disc starts playing upon insertion into the player.
 - **Off** – The player waits for the user to start playback by pressing the **PLAY** button.

4. **Auto Resume:** Select whether disc playback will start from the previously saved point or not. This setting applies to CDs, SACDs, DVDs and certain Blu-ray Discs.
 - **On** – Playback automatically starts from the previously saved point.
 - **Off** – Playback starts from the beginning.

5. **Power On Input:** Allows you to set the initial input source after power on. It is recommended that you set this option only if you plan to use the player as a dedicated processor or pre-amplifier.
 - **Blu-Ray** (default) – Power on with the regular Blu-ray Home Menu. This choice is recommended for regular use.
 - **Last Input** – Power on with the last input source. Depending on the availability of the input device, you may experience a blank screen on the display or “No signal” warning message.

6. **Parental Control:** Sets parental control ratings in order to prevent minors from watching inappropriate content. This function depends on whether the disc has been properly rated and encoded.
 - Press the **ENTER** button to bring up the rating selection menu.
 - Adjust the parental control settings by entering the current parental control password. If you have not yet set a parental control password, default the password is “0000”.
 - The **Parental Control Menu** contains the following sub-items:

- **BD Ratings** – Press the **UP/DOWN ARROW** buttons to select the rating allowed for Blu-ray Discs. **Off** means no ratings control and all discs are allowed to play. Numbers 1 to 21 corresponds to the age limit. Discs encoded with an age limit that is less than the selected age will be allowed, and any rating equal to or above the selected age will be blocked.
 - **DVD Ratings** – Press the **UP/DOWN ARROW** buttons to select the rating to allow for DVDs. The available ratings are Kid, G, PG, PG-13, PGR, R, NC-17, Adult and Off. The selected rating and above will be blocked, and any rating below will be allowed. If **Off** is selected, all discs are allowed to play.
 - **Area Code** – Some Blu-ray Discs may have different parental control ratings for different geographical areas. At this time the player only supports parental control ratings used in the United States.
 - **Change Password** – To change the parental control password, enter a 4-digit number as the new password. Enter the new password again to confirm. If the two entries match, the new password replaces the old parental control password.
7. **Language:** Configures language preferences. This menu contains the following sub-items:
- **Player Language** – Allows you to choose the language for the player's **Setup Menu** and the on-screen display. Currently the player supports 11 languages.
 - **Disc Menu Language** – Allows you to choose the preferred language for displaying DVD and Blu-ray Disc menus. If a disc menu of the selected language is available, that menu will be shown instead of the default disc menu.
 - **Audio Language** – Allows you to choose the preferred audio language for DVD and Blu-ray Discs. If an audio track of the selected language is available on the disc, the audio track will be played back.
 - **Subtitle Language** – Allows you to choose the preferred subtitle language for DVD and Blu-ray Discs. If a subtitle of the selected language is available, it will be displayed. When **Auto** is selected, the subtitle display is determined by the disc.

NOTE

If your preferred language is not listed in the Audio, Subtitle or Disc Menu options, select "Other" and enter the Language Code found on page 84 of this manual.

Video Setup

The **Video Setup** section of the **Setup Menu** allows you to configure video output options.

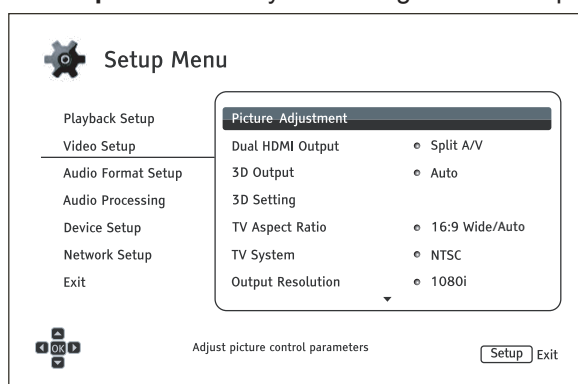

1. **Picture Adjustment:** Adjusts picture control settings. The BDP-103 provides a wide array of picture controls. Please refer to the **Picture Adjustment** section on page 56 for details about each control.
2. **Dual HDMI Output:** Allows you to select the output mode when both HDMI Output ports are in use. If only one HDMI Output is active, this selection will not apply.
 - **Split A/V** (recommended) – Use **HDMI 1 OUT** as the dedicated video output port and **HDMI 2 OUT** as the dedicated audio output port. This setting will ensure the best possible picture quality and the highest possible audio resolution.
 - **Dual Display** – Send digital audio and video signals to both HDMI Outputs simultaneously. This setting is only recommended when two HDMI displays are required, since the surround sound audio signal may be down-mixed to stereo and the original audio quality may be lost.

NOTE

- The player can automatically adjust the resolution of digital audio and video signals depending on the capabilities of the connected television and receivers.
- For HDMI 1 OUT, the dedicated QDEO video processor will be used unless **Source Direct** is selected, in which case QDEO is bypassed.
- In **Split A/V** mode, HDMI 1 OUT has video only with no audio, but HDMI 2 OUT will have audio and possibly video. This is because HDMI embeds audio into video data so there must always be a video signal, even if it's only a blank screen, to carry audio through.

3. **3D Output:** Allows you to choose the video output mode for 3D content.
 - **Auto** – Outputs 3D if supported both by both the disc content and the display. The player automatically checks for the existence of 3D content on the disc and the 3D compatibility of the TV or projector. If both criteria are met, the player sends 3D video from its HDMI output terminals; otherwise, only 2D video is sent out. 3D glasses (which are not sold by OPPO) are required to enjoy the 3D movie on your TV.
 - **Off** – Always output 2D video format, even when 3D video exists on the disc. This guarantees the video quality if your TV is not 3D compatible, or if some necessary components (such as the 3D glasses) are missing.
 - **Forced** – Always output 3D video format for 3D Blu-ray Discs. You may experience a black screen (no video output) if your TV is not 3D compatible.
4. **3D Setting:** Adjusts the playback settings for better 3D visual quality.
 - **Blank HDMI 2** (Yes/No) – Allows you to force HDMI 2 OUT to output a blank 2D screen when HDMI 1 OUT outputs 3D video. During 3D movie playback, when HDMI 1 is connected to a 3D display and HDMI 2 is connected to a non-3D receiver which is in turn connected to the same 3D display, you may encounter an issue where there is no audio coming from the receiver. Setting this option to **"Yes"** can resolve this issue.

- **2D->3D Depth** – Adjusts the 3D depth perception when performing 2D-to-3D conversion (also called “simulated 3D”). The default value is 8.
 - **3D TV Size** – Allows you to enter the diagonal screen size of the 3D HDTV. This option applies to 3D mode only. Use the number buttons on the remote to enter the actual diagonal size of the TV screen, and then press the **ENTER** button to confirm. The default value is 46 inches.
5. **TV Aspect Ratio:** Sets the aspect ratio of the player’s output image.
- **16:9 Wide** – Choose when the display is widescreen 16:9. 16:9 material will be displayed in its native aspect ratio, and 4:3 materials will be stretched horizontally.
 - **16:9 Wide/Auto** – Choose when the display is widescreen 16:9. 16:9 material will be displayed in its native aspect ratio, and 4:3 materials will be displayed with black borders on both sides in order to maintain the original 4:3 aspect ratio.

For a detailed description on how to choose a proper TV Aspect Ratio, please refer to the **Determine the Display Aspect Ratio** section on page 23 of this manual.

6. **TV System:** Allows you to choose the output video system or broadcast standard (PAL/NTSC) to match the type of TV.
- **NTSC** (default) – When playing NTSC-encoded discs, no system conversion is performed. PAL-encoded content is converted to NTSC output. Blu-ray Discs encoded at a 24Hz frame rate are converted to a 60Hz frame rate if neither 1080p24 Output nor Source Direct output resolution is enabled.
 - **PAL** – When playing PAL-encoded discs, no system conversion is performed. NTSC-encoded content is converted to PAL output. Blu-ray Discs encoded with a 24Hz frame rate are converted to a 50Hz frame rate if neither 1080p24 Output nor Source Direct output resolution is enabled.
 - **Multi-system** – No system conversion is performed. The output video system is the same as that encoded on the disc. Blu-ray Discs encoded with a 24Hz frame rate are converted to a 60Hz frame rate if neither the 1080p24 Output nor Source Direct output resolution is enabled. Requires a TV that supports both NTSC and PAL systems.

NOTE

DO NOT select **Multi-system** if your TV does not support both NTSC and PAL systems. The TV display may become a black screen when you insert a disc encoded in a different system than your TV supports. Should this happen, you can press the **OPEN** button to eject the disc tray, and then use the Setup Menu to correct the **TV System** setting.

7. **Output Resolution:** Allows you to choose the output resolution that best matches your television’s native resolution. For a detailed description on how to choose a proper output resolution, please refer to the **Select the Best Output Resolution** section on page 22 of this manual.
8. **1080p24 Output:** Allows you to set the 1080p 24Hz output options. This option only applies to the HDMI output at 1080p resolution. Many Blu-ray Discs of theatrical movies are encoded using 24Hz frame rate, the same number of frames per second as the original theatrical film. If the TV properly supports 1080p 24Hz, smoother motion can be achieved by enabling **1080p24 Output** for these discs.
- **Auto** (default) – Video encoded at a 24Hz frame rate will be output as 1080p 24Hz if the TV informs the player that it can support the 1080p24 signal.
 - **Forced** – Video encoded at a 24Hz frame rate will be output as 1080p 24Hz without regard to whether the TV can support the 1080p24 signal or not. This is useful if the TV can actually support 1080p24 but does not properly state its capability. Please note that if the TV cannot support 1080p24, selecting this option will result in no video.
 - **Off** – Video encoded at a 24Hz frame rate will be converted to 60Hz (NTSC) or 50Hz (PAL).

9. **DVD 24p Conversion:** Allows you to enable 24Hz frame rate conversion for DVD. This option is only available when **1080p24 Output** is enabled (set to **Auto** or **Forced**). Many DVDs that originate from theatrical movies are encoded with a technique called “3:2 telecine” in order to convert the 24 frames per second film to 60Hz video signal. The player can convert the 60Hz video signal back to 24 frames per second film and output as 1080P/24Hz. Smoother motion may be achieved by enabling this option, if both the TV and the DVD disc meet the conversion conditions. The available options are:
- **On** – Converts DVD to 24Hz frame rate when possible. Remember that motion errors may be observed if the DVD is not suitable for such conversion.
 - **Off** (default) – Does not convert DVD to 24Hz frame rate.
10. **4Kx2K Output:** Allows you to set the 4Kx2K resolution options. This option only applies to the HDMI output at 4Kx2K resolution.
- **Auto (default)** – Output 4Kx2K if the resolution is supported by the display and the content is suitable for 4K up-scaling. The player automatically checks for 4K compatibility of the TV or projector. If the display is compatible and the content being played has a 24Hz (or 23.976Hz) frame rate, the player sends 4Kx2K video from its HDMI output terminal; otherwise, the HDMI video is sent out at 1080p resolution or less depending on the display’s capability.
 - **Forced** – Always output 4Kx2K video format regardless of whether the TV or projector supports it, or whether the content being played is suitable for 4K up-scaling. You may experience a black screen (no video output) if the display is not 4K compatible. For content that has a 50Hz or 60Hz (59.95Hz) frame rate, the output will be 4Kx2K at 25Hz or 30Hz (29.97Hz), and video quality may not be optimal due to frame rate conversion.
11. **HDMI Options:** Configures video options that apply only to the HDMI output. This item contains a sub-menu with multiple configuration options. Please refer to the **HDMI Options** section on page 59 of this manual for details of each option.
12. **Display Options:** Configures the options for displaying on-screen information.
- **Subtitle Shift** – Sets the display position for subtitles.

When the **Subtitle Shift** is set at 0 (default), subtitles are displayed at the original position as specified on the disc. When it is set at a value between 1 and 10, subtitles are shifted up. When it is set at a value between -1 and -10, subtitles are shifted down.

This feature is helpful for customers using a 2.35:1 “Constant Image Height” video projection system. Subtitles can be shifted to the active video area so they do not get cut off. You can also press and hold the **SUBTITLE** button for 3 seconds to activate this selection.
 - **OSD Position** – Allows you to set the display position for the on-screen display (OSD).

When the **OSD Position** is set to 0, the OSD is shown at the top and bottom of the video screen. When it is set at a value between 1 and 5, the OSD is shifted towards the centre of the video screen.

Similar to the subtitle shift setting above, the **OSD Position** feature is helpful for customers using a 2.35:1 “Constant Image Height” video projection system.
 - **OSD Mode** – Allows you to select how long the on-screen display (OSD) information, such as playback operation icons (**PAUSE**, **STOP**, **SKIP**, etc.), stays on the TV screen.
 - **Normal** – OSD information stays on the TV screen until the user cancels it.
 - **Minimal** – OSD information stays on the TV screen for a few seconds and then disappears. The front panel display still maintains the selected display information.

SETUP MENU OPTIONS

- **Remaining** – OSD information stays on the TV screen until the user cancels it. By default, displays remaining time instead of elapsed time.
- **Off** – No OSD information shows on the TV screen unless the user presses the INFO button. This mode is not recommended for daily use.
- **Angle Mark (On/Off)** – Turns on/off the display of the angle icon when a DVD or Blu-ray Disc with multiple angles is played. Keeping the angle mark off avoids distraction from normal movie watching.
- **Screen Saver** – Allows you to turn on/off the screen saver function. The screen saver is designed to minimize burn-in concerns for plasma and CRT display devices.
 - **On (recommended)** – After about 3 minutes of inactivity, the player will show an animated OPPO logo moving on a black background. This allows most areas of the screen time to rest and gives all areas an equal opportunity to refresh.
 - **Off** – The screen saver will not be activated. Only use this option if your TV does not have any burn-in issues.
 - **Energy Saver** – Video output will be turned off after 3 minutes of inactivity. Many projectors and LCD TVs will go into a standby or sleep mode and turn off their projection lamp or LCD backlight lamp, thus saving energy and prolonging the lamp life. When you press any button on the OPPO remote control or the player’s front panel, the screen saver will be canceled and video output will be restored. If your TV is already in standby or sleep mode, you may need to wake up the TV by pressing a button on its remote or control panel.

Picture Adjustment

Picture Adjustment is a special section of the **Video Setup** menu. It allows you to fine tune many picture control parameters in order to achieve optimal picture quality. To enter the **Picture Adjustment** menu, press the **SETUP** button on the remote control to enter the player’s **Setup Menu** and choose **Video Setup > Picture Adjustment** and select the video output to be adjusted:

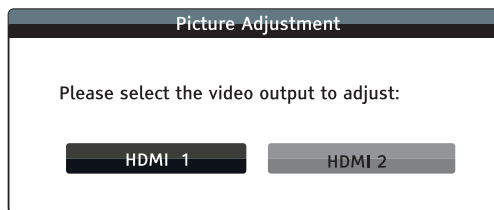

Use the **LEFT/RIGHT ARROW** to select the video output, and press the **ENTER** button to bring up the **Picture Adjustment** menu. Depending on the selected video output, the **Picture Adjustment** menu may be slightly different:

HDMI 1			
Picture Mode	◀	Mode 1	▶
Brightness	0	-16 _____ _____ +16	
Contrast	0	-16 _____ _____ +16	
Hue	0	-16 _____ _____ +16	
Saturation	0	-16 _____ _____ +16	
Sharpness	0	-16 _____ _____ +16	
Noise Reduction	0	0 _____ _____ +8	
Color Enhancement	0	0 _____ _____ +4	
Contrast Enhancement	0	0 _____ _____ +4	
Exit			

Picture Adjustment Menu for HDMI 1

HDMI 2			
Picture Mode	◀ Mode 1 ▶		
Brightness	0	-16	◯ ◯ +16
Contrast	0	-16	◯ ◯ +16
Hue	0	-16	◯ ◯ +16
Saturation	0	-16	◯ ◯ +16
Sharpness	0	0	◯ ◯ +2
Noise Reduction	0	0	◯ ◯ +3
Exit			

Picture Adjustment Menu for HDMI 2

To change a picture adjustment parameter, use the **UP/DOWN ARROW** buttons to highlight the parameter, and use the **LEFT/RIGHT ARROW** buttons to change its value.

To aid in the adjustment of picture control parameters, the picture adjustment menu will be reduced to only show the parameter being adjusted once you press the **LEFT/RIGHT ARROW** buttons (except the **Picture Mode**, which you will directly see the mode name switches between Mode 1, 2 and 3, and all the other parameters are adjusted automatically to the stored value). The reduced menu will be positioned near the bottom of the screen.

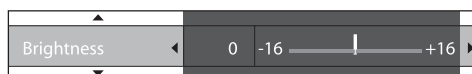

You can continue adjusting the current parameter by pressing the **LEFT/RIGHT ARROW** buttons. To select another parameter, press the **UP/DOWN ARROW** buttons. Press the **ENTER** button to return to the main **Picture Adjustment** menu.

To exit the **Picture Adjustment** menu and return to the **Setup Menu**, either select **Exit** in the menu, or press the **RETURN** button.

The following picture adjustment controls are available for both HDMI 1 and 2:

1. **Picture Mode:** Allows you to choose a customized picture mode saved by you. The BDP-103 allows you to save up to three customized modes. Press the **LEFT/RIGHT ARROW** buttons to switch the mode and all parameters will be automatically adjusted to their stored values. Changes to the current parameter values will be stored automatically when you exit the **Picture Adjustment** screen or switch to another **Picture Mode**.
2. **Brightness:** Allows you to adjust the brightness (black level) of the video output.
3. **Contrast:** Allows you to adjust the contrast (white level) of the video output.

NOTE

Proper brightness and contrast settings are necessary for a quality video output. If you do not have the correct black and white levels, your images can appear washed out or can lose detail in shadows when watching darker scenes. Televisions have brightness (black level) and contrast (white level) controls; however, it may require a combination of tweaking both the player and your television to get the optimal result. We recommend using a calibration disc such as the *Spears & Munsil™ High Definition Benchmark Blu-ray Edition* or *Digital Video*

Essentials HD Basics as aids for adjusting. First adjust the television's picture controls for the best possible picture. Once that is done, try changing the player's settings to further refine the picture to the optimal result.

4. **Hue:** Allows you to adjust the hue (tint) of the video output.
5. **Saturation:** Allows you to adjust the saturation (color intensity level) of the video output.
6. **Sharpness:** Allows you to set the sharpness of video output. Sharpness (also called Detail/Edge Enhancement in previous OPPO players) is a video processing function that can control the image sharpness but at the same time may cause unwanted artifacts.

For **HDMI 1**, the sharpness level can be set between -16 and +16. The default is level 0, which turns off sharpness enhancement. The negative levels may be used to reduce or eliminate overly sharpened video. However, the picture may appear soft. The positive levels increase the sharpness.

- At level 1, the player applies low level Detail Enhancement, during which the video processor isolates the detailed parts from the original image, processes them separately and integrates back before the final output.
- At level 2, the player increases Detail Enhancement to a higher level. Generally, to make an image "sharper", we recommend using level 1 and 2.
- At level 3 and above, the player adds Luminance Transition Improvement (LTI) and Chroma Transition Improvement (CTI), which further sharpen the luminance transition and chroma transition. However, we do not recommend using level 3 and above unless the source content is poorly produced and blurry.

For **HDMI 2 OUT**, the sharpness level can be set between 0 and +2. The default is level 0. The higher the level, the sharper the video details are. However, too high a sharpness level may cause white lines or halo-like effects to appear around objects.

7. **Noise Reduction:** Allows you to select whether the player will apply video noise reduction processing.

For **HDMI 1**, the noise reduction level can be set between 0 and 8. The default is level 0, which turns off noise reduction.

- When set to level 1, the player adjusts the picture quality by reducing the "mosquito noise" (artifacts around the outlines of objects) and "block noise" (mosaic-like patterns caused by video compression). These two noise reduction methods are also called Compression Artifacts Reduction (CAR) and have several levels of aggressiveness.
- When set to level 2, the player applies the Motion Adaptive Video Noise Reduction (VNR), which handles the random noise and the film-grain noise (natural variation of picture intensity caused by film grain). Its level is automatic because there is noise estimator circuitry in the video processor that calculates how much noise is present and adjusts the level of VNR accordingly.
- When set to 3 or 4, the player applies both CAR and Motion Adaptive VNR, with more aggressive "block noise" reduction at level 4.
- At level 5, the player applies aggressive CAR for low quality video content, and adds Motion Adaptive VNR at level 6.
- At level 7, the player applies the most aggressive CAR for very low quality video, and adds Motion Adaptive VNR at level 8.

Remember that excessive noise reduction may cause a loss of details. We recommend using the noise reduction function only when you encounter poorly encoded or compressed video that has apparent noise artifacts.

For **HDMI 2**, the noise reduction level can be set between 0 and +3. The default is level 0. When this level is increased, the player adjusts the picture quality by applying mosquito noise reduction, random noise reduction and MPEG block noise reduction at the same time. The higher the level, the more aggressive noise reduction functions apply.

The following picture adjustment controls are only available for **HDMI 1** video output:

8. **Color Enhancement:** Allows you to adjust the color enhancement level on the video output. This enhances certain colors in the spectrum and enables vivid colors in outdoor scenes without causing hue shifts, loss of detail or changes in skin tones.
9. **Contrast Enhancement:** Allows you to adjust the contrast enhancement level on the video output. This expands detail in shadows.

HDMI Options

HDMI Options is a sub-menu of the **Video Setup** menu. It allows you to configure some video settings that are unique to the HDMI output. To enter this sub-menu, select **HDMI Options** from the **Video Setup** menu. To exit this sub-menu, press the **RETURN** button or the **LEFT ARROW** key. The following HDMI options are available:

1. **Color Space (HDMI 1)** – Allows you to select the color space for the HDMI 1 output. The available options are:
 - **Auto** (recommended) – The player checks with the display device to automatically determine what color space to use. If the display device supports YCbCr 4:4:4, then it will be used to avoid extra color space conversion.
 - **RGB Video Level** – The HDMI output uses RGB color space and normal signal range suitable for video displays.
 - **RGB PC Level** – The HDMI output uses RGB color space and expands the signal range. The expanded signal range is suitable for personal computer (PC) displays. Some TVs are designed to be used as a PC monitor, and expect signal in expanded RGB range when the DVI input is selected. For these displays if the video signal uses the normal RGB range, the black-white contrast will be reduced. You can set the player to use the RGB PC Level output and restore proper contrast.
 - **YCbCr 4:4:4** – The HDMI output uses YCbCr 4:4:4 color space.
 - **YCbCr 4:2:2** – The HDMI output uses YCbCr 4:2:2 color space. Generally this is the color space that is closest to the color space encoded on the discs. (All discs are encoded in YCbCr 4:2:0 color space, and the video decoder decodes it into YCbCr 4:2:2.)
2. **Color Space (HDMI 2)** – Allows you to select the color space for the HDMI 2 output. The available options are the same as those for **Color Space (HDMI 1)**.
3. **Deep Color (HDMI 1)** – Allows you to select the Deep Color mode for the HDMI 1 output. Deep Color is an option for some TVs or projectors that feature HDMI v1.3 or higher input. Normally, each pixel of the video image is transmitted using 24-bit data (8-bit per channel for R, G, B or Y, Cb, Cr). If Deep Color is supported, each pixel of the video image can be transmitted using 30-bit (10-bit per channel) or 36-bit (12-bit per channel) data. The increased bit depth should result in smoother color transitions and better gradients.
 - **36 Bits** – Uses the 36-bit per pixel Deep Color mode.

- **30 Bits (Dithered)** – Uses the 30-bit per pixel Deep Color mode with dithering technique.
 - **30 Bits** – Uses the 30-bit per pixel Deep Color mode.
 - **Off (Dithered)** – Does not use Deep Color, but applies the dithering technique.
 - **Off (default)** – Does not use Deep Color.
4. **Deep Color (HDMI 2)** – Allows you to select the Deep Color mode for the HDMI 2 output. The available options are the same as those for **HDMI Deep Color (HDMI 1)**.

NOTE

- Since the Deep Color feature is optional and may not be supported by all TVs, enabling Deep Color while connected to a TV without this feature may result in no effect or no video.
 - At this time, no disc is encoded with Deep Color. Enabling Deep Color will not magically make colors richer, but will help preserve the maximum precision as a result of video processing and picture control adjustment.
 - **Dithering** is a technique to improve the image color depth with limited color quantization.
5. **De-interlacing Mode** – Allows you to select the appropriate algorithm that the player should use to convert interlaced video on a DVD or Blu-ray Disc to progressive output. A proper de-interlacing mode will ensure the output video matches the original contents and is free of de-interlacing artifacts. The available options are:
- **Auto (default)** – Automatically selects the de-interlacing mode depending on the video type. This is the recommended setting as it sets the player to optimally process a variety of signal types.
 - **Film** – De-interlacing the video originally made in film mode. The mode may improve film mode detection in some cases.
 - **Video** - De-interlacing the video originally shot with a video camera. Use this setting only if you are certain the disc is made from footage originally not shot with a film camera.

Audio Format Setup

The **Audio Format Setup** section of the **Setup Menu** allows you to configure preferences for audio output formats.

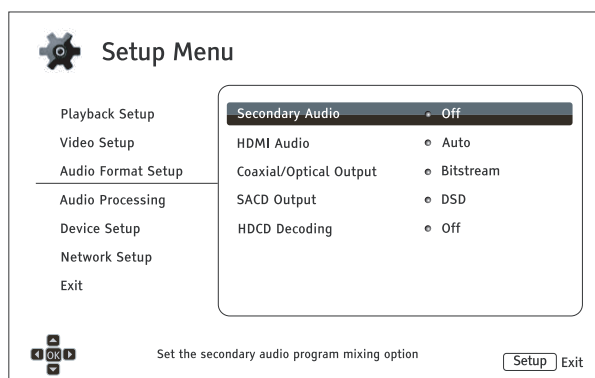

1. **Secondary Audio:** Allows you to set the Secondary Audio Program mixing option. Some Blu-ray Discs contain a secondary audio and video program, such as a director's commentary. Some Blu-ray Discs have a sound effect when you make menu choices. This **Setup Menu** item allows you to decide whether to mix the Secondary Audio Program and menu sounds into the primary audio.
 - **On** – The Secondary Audio Program and menu sounds are mixed into the primary audio. Usually this will cause the primary audio volume to be slightly reduced.
 - **Off (default)** – The Secondary Audio Program and menu sounds are not mixed into the primary audio and you cannot hear the secondary audio or menu sounds. This setting is recommended since it preserves the highest possible audio quality for the primary audio.

2. **HDMI Audio:** Allows you to select the digital audio output format from the HDMI port. The options are:
 - **Auto** (default) – The player checks with the device connecting to the HDMI output to automatically determine which audio format to use.
 - **LPCM** – Digital audio output via HDMI will be in the multi-channel Linear PCM format. When this option is selected, compressed audio bit streams will be decoded by the player. This setting is recommended when connecting the HDMI output directly to a TV or to a receiver without advanced audio decoding capabilities.
 - **Bitstream** – Digital audio output via HDMI will be in bitstream format. This option is recommended when connecting the HDMI output to an A/V receiver or processor that supports advanced audio decoding, such as Dolby TrueHD and DTS-HD Master Audio.
 - **Off** – No digital audio output via HDMI.

NOTE

If you use HDMI to connect audio to an HDMI A/V receiver or audio processor, it is important that you choose 720p or higher HDMI output resolution when playing high resolution audio content (DVD-Audio, SACD, Dolby TrueHD and DTS-HD Master Audio). According to the HDMI specification, the bandwidth available for audio is proportional to the total bandwidth used by video. At 480p/576p resolution, the HDMI specification can only support 2 channels of audio with high sample rate (up to 192kHz), or 8 channels of audio with standard sample rate (up to

48kHz). If you play high resolution audio content at the 480p/576p resolution, you may get reduced audio resolution, incomplete audio channels, or even no audio/video output at all. Choosing a higher output resolution such as 720p or above allows enough bandwidth for all high sample rate audio channels.

3. **Coaxial/Optical Output:** Allows you to set the audio format and the upper sample rate limit for coaxial/optical (S/PDIF) digital outputs. The upper sample rate limit is used to decide whether the player will down-sample audio (the player does not up-sample audio to higher sample rates).
 - **48k LPCM** – Forces down-mixed 2-channel, linear PCM (LPCM) digital audio format, and sets the maximum sample rate to 48kHz. This is supported by most receivers/amplifiers.
 - **96k LPCM** – Forces down-mixed 2-channel, linear PCM (LPCM) digital audio format and sets the maximum sample rate to 96kHz. It can result in better audio quality but ensure the receiver/amplifier can support it.
 - **192k LPCM** – Forces down-mixed 2-channel, linear PCM (LPCM) digital audio format and sets the maximum sample rate to 192kHz. It can result in better audio quality but ensure the receiver/amplifier can support it.
 - **Bitstream** – Passes audio as compressed bitstream format to the receiver/amplifier. Choose this setting if your receiver/amplifier is capable of decoding Dolby Digital and/or DTS.

NOTE

Due to copyright restrictions and bandwidth limitations, SACD audio cannot be sent through the coaxial/optical audio output, and the high resolution audio on DVD-Audio and Blu-ray discs will be sent out at reduced resolution. Details can be found on page 17.

4. **SACD Output:** Allows you to select the audio output format for SACD playback.
 - **PCM** – SACD data is converted into multi-channel, high-resolution PCM data. The converted PCM data is then output through HDMI or the internal DAC (Digital to Analog Converter) for the analog audio output ports. If you use a receiver that supports HDMI v1.1 to listen to SACD, please select this option. You may also want to select this option if you prefer the sound quality of the DSD-to-PCM conversion.
 - **DSD** – SACD Direct Stream Digital (DSD) data is output over HDMI without any conversion. For the analog audio outputs, DSD data is converted into an analog signal directly by the internal DAC. If you use a receiver that supports HDMI v1.2a with DSD over HDMI, or you prefer the sound quality of straight DSD to analog, please select this option.
 - **Auto** (default) – The player checks with the device connected to the HDMI output to automatically determine which audio format (DSD or PCM) to use for SACD playback.

NOTE

Due to the hardware limitation, DSD output is only available from the HDMI 2 OUT port. To listen to SACD using the HDMI 1 OUT port, please set **SACD Output** to **PCM**.

5. **HDCD Decoding:** Allows you to set the audio decoding option for HDCD (High Definition Compatible Digital) discs.
 - **On** – HDCD is decoded by the player. You can enjoy expanded dynamic range and improved audio resolution.
 - **Off** – HDCD is treated as regular CD. This is useful when the player is connected to an HDCD-capable A/V receiver via a digital audio output link (Coaxial, Optical, or HDMI) so the A/V receiver can perform HDCD decoding.

NOTE

If your receiver is capable of HDCD decoding, it is recommended that you set the **HDCD Decoding** setting to **Off** on the BDP-103 in order to avoid decoding HDCD twice. This will prevent the occasional pop or crackle sounds that occur when HDCD is decoded twice.

Audio Signal Reference Chart

Blu-ray Discs may contain many types of audio signal formats, some of which are high resolution types such as Dolby TrueHD and DTS-HD Master Audio. Blu-ray Discs also have many optional audio components such as the Secondary Audio Program and menu clicking sound. The player's **Audio Format** setup menu allows you to configure the audio output to meet your specific preference. The following chart provides a reference to what type of audio signal can be expected.

When **Secondary Audio** is set to **Off**:

Output Ports		HDMI Output		Coaxial/Optical Output		Analog Multi-Channel Output
Source Format	Setting	Bitstream	LPCM	Bitstream	LPCM	
LPCM 2ch		LPCM 2ch	LPCM 2ch	LPCM 2ch	LPCM 2ch	2ch
LPCM 5.1ch		LPCM 5.1ch	LPCM 5.1ch	DTS 5.1ch	LPCM 2ch	5.1ch
LPCM 7.1ch		LPCM 7.1ch	LPCM 7.1ch	DTS 5.1ch	LPCM 2ch	7.1ch
Dolby Digital		Dolby Digital	LPCM 5.1ch	Dolby Digital	LPCM 2ch	5.1ch
Dolby Digital Plus		Dolby Digital Plus	LPCM up to 7.1ch	Dolby Digital	LPCM 2ch	Up to 7.1ch
Dolby TrueHD		Dolby TrueHD	LPCM up to 192kHz 24-bit 7.1ch	Dolby Digital	LPCM 2ch	Up to 7.1ch
DTS		DTS	LPCM up to 7.1ch	DTS	LPCM 2ch	Up to 7.1ch
DTS-HD High Resolution		DTS-HD High Resolution	LPCM up to 7.1ch	DTS (core)	LPCM 2ch	Up to 7.1ch
DTS-HD Master Audio		DTS-HD Master Audio	LPCM up to 96kHz 24-bit 7.1ch or 192kHz 24-bit 2ch	DTS (core)	LPCM 2ch	Up to 7.1ch

When **Secondary Audio** is set to **On** and the player encounters a disc with a secondary audio track or menu sounds:

Output Ports		HDMI Output		Coaxial/Optical Output		Analog Multi-Channel Output
Source Format	Setting	Bitstream	LPCM	Bitstream	LPCM	
LPCM 2ch		LPCM 2ch	LPCM 2ch	LPCM 2ch	LPCM 2ch	2ch
LPCM 5.1ch		LPCM 5.1ch	LPCM 5.1ch	DTS 5.1ch	LPCM 2ch	5.1ch
LPCM 7.1ch		LPCM 7.1ch	LPCM 7.1ch	DTS 5.1ch	LPCM 2ch	7.1ch
Dolby Digital		Dolby Digital*	LPCM up to 5.1ch	Dolby Digital*	LPCM 2ch	5.1ch
Dolby Digital Plus		Dolby Digital*	LPCM up to 7.1ch	Dolby Digital*	LPCM 2ch	Up to 7.1ch
Dolby TrueHD		Dolby Digital*	LPCM up to 192kHz 24-bit 7.1ch	Dolby Digital*	LPCM 2ch	Up to 7.1ch
DTS		DTS*	LPCM up to 7.1ch	DTS*	LPCM 2ch	Up to 7.1ch
DTS-HD High Resolution		DTS*	LPCM up to 7.1ch	DTS*	LPCM 2ch	Up to 7.1ch
DTS-HD Master Audio		DTS*	LPCM up to 7.1ch	DTS*	LPCM 2ch	Up to 7.1ch

Note: All audio output signals are mixed with primary, second audio and menu sounds. "Dolby Digital*" and "DTS*" denote mixed audio re-encoded into the original bitstream audio format.

Recommended Audio Format Options

Depending on your specific audio/video connection method, the audio format options of the BDP-103 may need to be adjusted to match your configuration. Refer to the video and audio connection methods described previously in this guide and the following audio setup guidelines.

Audio Connection Directly to TV

If the player is connected directly to the TV through HDMI (as described on page 13) or through DVI and analog L/R audio cables (as described on page 15), it is recommended that you use the following audio format options:

- **Secondary Audio:** **On**
- **HDMI Audio:** **LPCM**
- **SACD Output:** **PCM**
- **HDCD Decoding:** **On**
- **Coaxial/Optical Output:** (any – not in use)

Multi-Channel Digital Audio to Receiver through HDMI

If the player is connected to an A/V receiver or processor with HDMI inputs (as described on page 11), you can send all current audio formats to your receiver in pure digital form. To get the best possible audio via HDMI, you may need to set the following options on the player's **Audio Format** setup menu:

- If your receiver supports HDMI v1.3 with decoding capability for high resolution lossless audio formats such as Dolby TrueHD and DTS-HD Master Audio, please use the following audio format options:

- **Secondary Audio:** **Off** (or On if you need secondary audio)
- **HDMI Audio:** **Bitstream**
- **SACD Output:** **PCM** (or DSD if the receiver supports DSD over HDMI)
- **HDCD Decoding:** **On** (or Off if the receiver can decode HDCD)
- **Coaxial/Optical Output:** (any – not in use)

- If your receiver supports HDMI v1.1/1.2 Multi-Channel PCM audio, but not high resolution lossless audio formats such as Dolby TrueHD and DTS-HD Master Audio, please use the following audio format options:

- **Secondary Audio:** **Off** (or On if you need secondary audio)
- **HDMI Audio:** **LPCM**
- **SACD Output:** **PCM** (or DSD if the receiver supports DSD over HDMI)
- **HDCD Decoding:** **On** (or Off if the receiver can decode HDCD)
- **Coaxial/Optical Output:** (any – not in use)

Multi-Channel Analog Audio to Receiver

If the player is connected to an A/V receiver through the 7.1ch or 5.1ch analog audio jacks using 8 or 6 RCA cables (as described on page 16), you can play all supported audio formats and listen to them with your A/V receiver and surround sound systems. The following audio format setup options are recommended:

- **Secondary Audio:** **Off** (or On if you need secondary audio)
- **HDMI Audio:** **Off**
- **SACD Output:** **PCM** or **DSD** (depending on your listening preference)

SETUP MENU OPTIONS

- **HDCD Decoding:** **On**
- **Coaxial/Optical Output:** (any – not in use)

Also set the **Speaker Configuration** in the **Audio Processing** menu:

- Set **Down Mix** to **7.1Ch** or **5.1Ch**.
- Set the speaker size and subwoofer according to your actual audio hardware. (see page 69)
- Enable or select the multi-channel analog inputs on your receiver

Coaxial or Optical Digital Audio to Receiver

If the player is connected to an A/V receiver with Coaxial/Optical inputs (as described on page 17), and the A/V receiver supports Dolby Digital and DTS decoding, the following audio format setup options are recommended:

- **Secondary Audio:** **Off** (or On if you need secondary audio)
- **HDMI Audio:** **Off**
- **SACD Output:** (any – SACD is not available through optical/coaxial output)
- **HDCD Decoding:** **On** (or Off if the receiver can decode HDCD)
- **Coaxial/Optical Output:** **Bitstream**

Stereo Analog Audio to Receiver

If you primarily listen to stereo content or if your receiver only offers stereo audio connections, please use the analog RCA-style cables to connect the FL (Front Left) and FR (Front Right) terminals of the player to your receiver (as described on page 16). The following audio format options are recommended:

- **Secondary Audio:** **Off** (or On if you need secondary audio)
- **HDMI Audio:** **Off**
- **SACD Output:** **PCM** or **DSD** (depending on your listening preference)
- **HDCD Decoding:** **On**
- **Coaxial/Optical Output:** (any – setting to 192k LPCM may help to get the best analog audio quality)

Audio Processing Setup

The **Audio Processing** section of the **Setup Menu** allows you to configure how the player will process audio signals before sending them to the output. In this section, all of the settings only affect the analog audio outputs, with a few exceptions listed in the “Note” section below.

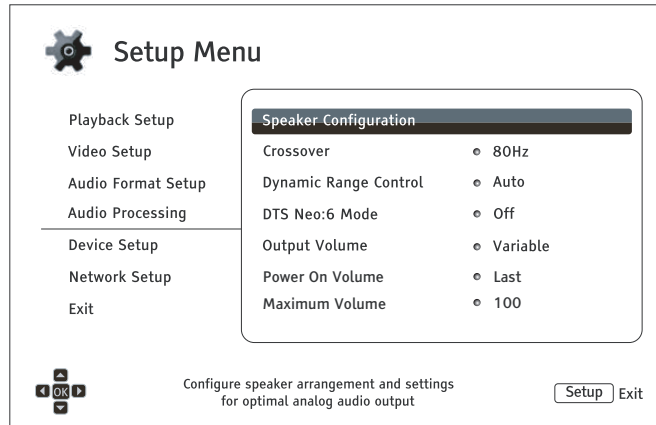

Speaker Configuration

In the **Speaker Configuration** menu you can configure speaker settings such as down-mix mode, number of speakers, their distance, size and trim level. The **Speaker Configuration** menu shows an illustration of speaker placement to assist you in properly configuring your speakers.

Upon entering this menu, the cursor is positioned on the front left speaker. You may use the **LEFT/RIGHT ARROW** buttons to move the cursor. The **RIGHT ARROW** button moves the cursor clockwise, and the **LEFT ARROW** button moves the cursor counterclockwise. When the cursor is over the **Down Mix**, **Test Tone** or **Exit** options, you can also use the **UP/DOWN ARROW** buttons to highlight these options.

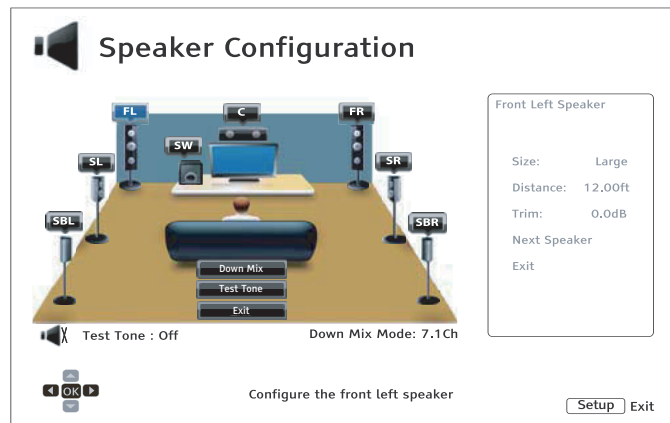

NOTE

- **Dynamic Range Control (DRC)** and **A/V Sync** also affect the HDMI, coaxial, and optical outputs.
- **Speaker Configuration** mainly applies to the multi-channel analog audio outputs. However, when **Coaxial/Optical Output** is set to **LPCM** in the **Setup Menu**, its signal becomes a down-mixed stereo version of the multi-channel signal that is sent to the multi-channel analog audio outputs. As a result, the LPCM signal from the coaxial and optical output is affected by the settings in **Speaker Configuration**.
- HDMI is unaffected by the settings in **Speaker Configuration**, and the coaxial and optical outputs are also unaffected by these settings when **Coaxial/Optical Output** is set to **Bitstream**.

Down Mix Mode

Downmixing is the process of converting multi-channel audio to a lesser number of channels. For example, converting a 5.1ch source to stereo or converting a 7.1ch source to 5.1ch. Downmixing allows the audio output from the player to match the exact number of speakers available in your home theater.

The current down mix mode is displayed in the lower right corner of the speaker placement illustration. To change the audio down mix setting, press the **ENTER** button while the cursor is over the **Down Mix** option. The following down mix modes are available:

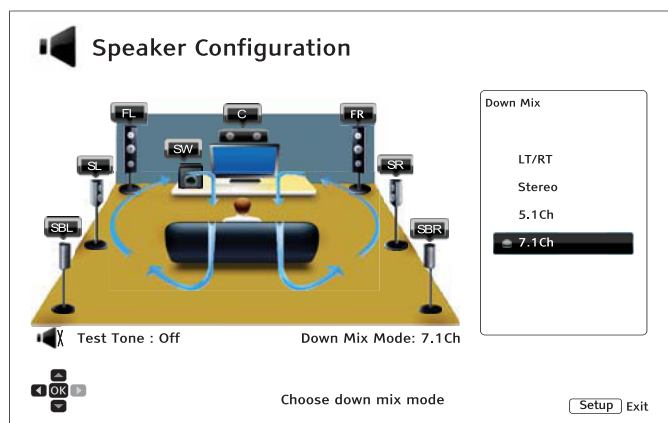

- **LT/RT** – Left Total/Right Total. The center and surround channels are mixed into the two front channels according to the LT/RT matrix. A Dolby Pro Logic receiver will decode the two-channel audio into surround audio.
- **Stereo** – This mode down mixes multi-channel audio to 2-channel stereo output. For original stereo content the output will not change. For original multi-channel content the surround and center channels will be mixed with the left and right front channels. This is recommended for use with TV sets or stereo receiver/amplifiers.
- **5.1Ch** – This mode enables 5.1ch decoded audio output. The number of actual output channels depends on the disc. If the source content has more channels, the surround back channels will be mixed into the surround channels.
- **7.1Ch** – This mode enables 7.1ch decoded audio output. The number of actual output channels depends on the disc. For 6.1ch contents, the left and right surround back speakers will both output the same surround back audio channel.

Test Tone

Test tones are artificially-created sounds that are used to test your audio speaker system and help to identify any wiring faults. By default the **Test Tone** is set to **Off**, with the status displayed in the lower left corner of the screen.

To begin the test, press the **ARROW** buttons to highlight the **Test Tone** option, and press the **Enter** button to change the test tone status to **On**. Press the **ARROW** buttons to select a speaker, and you will hear the test sounds. To stop the test process, press the **ARROW** buttons to highlight the **Test Tone** option and press the **Enter** button to switch the status back to **Off**.

Please note these test tones only work with the multi-channel analog audio outputs and are only suitable for channel identification purposes. For comprehensive speaker configuration, we recommend using the dedicated test tones found on professional audio calibration discs.

Speaker Settings

You can set the size, distance and trim level for each speaker by using the **LEFT/RIGHT ARROW** buttons to move the cursor to highlight the speaker and then press the **ENTER** button. The **Speaker Settings** menu on the right side of the screen will be activated. In **Speaker Settings**, use the **UP/DOWN ARROW** buttons to select a parameter, and then press the **ENTER** button to change it. To exit the **Speaker Settings** menu and return to the Speaker Configuration illustration, press the **LEFT ARROW** button or select the **Exit** option. You can also move on to configure the next speaker by selecting the **Next Speaker** option.

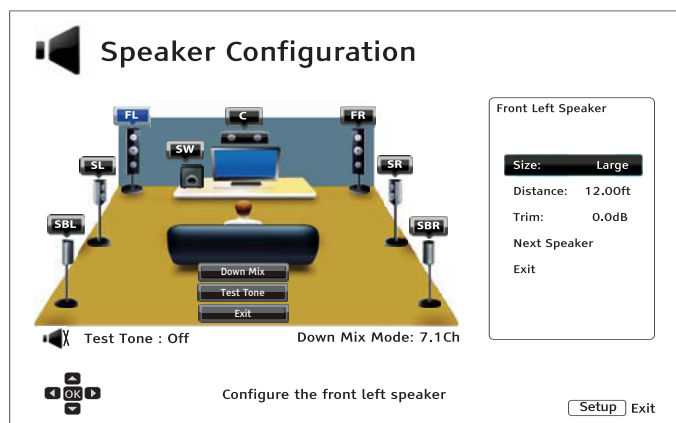

The following speaker parameters can be configured:

1. **Size:** The following speaker size parameters control bass filtering for the speakers.
 - **Large** – All audio content is passed to the appropriate speaker.
 - **Small** – All audio content, except for bass frequencies, is passed to the appropriate speaker. The purpose is to reduce possible distortion. If a subwoofer is available, bass frequencies are re-directed to the subwoofer, otherwise, they are discarded. The bass frequency upper limit is set by the **Crossover Frequency** selection in the **Setup Menu** (see page 71 for details).
 - **Off** – Speaker for the corresponding position does not exist. Audio for the missing speaker is redirected to other speakers or discarded if redirection is not possible.
 - **On** (for Subwoofer only) – Specifies that a subwoofer is available.

NOTE

The **Size** for Front, Surround and Surround Back speakers is configured in pairs. Changes to the size of one speaker will automatically change the other of the pair.

2. **Distance:** The speaker distance parameters set delay control for the corresponding audio channel. The delay is to compensate for the audio propagation time difference caused by the placement of speakers.

Speaker distance compensation is not required if the A/V receiver has the capability to adjust channel delay and compensate for speaker distance differences. However, if your receiver does not have such functions (most receivers do not offer these functions for their multi-channel analog input), you may adjust them through the player. Speaker distance delay is only applied if the player is decoding multi-channel audio. If you use bitstream audio output to your A/V receiver, the bitstream audio is not adjusted for speaker distance delay.

SETUP MENU OPTIONS

A typical 7.1-channel speaker layout and their speaker distance measurements are displayed as below:

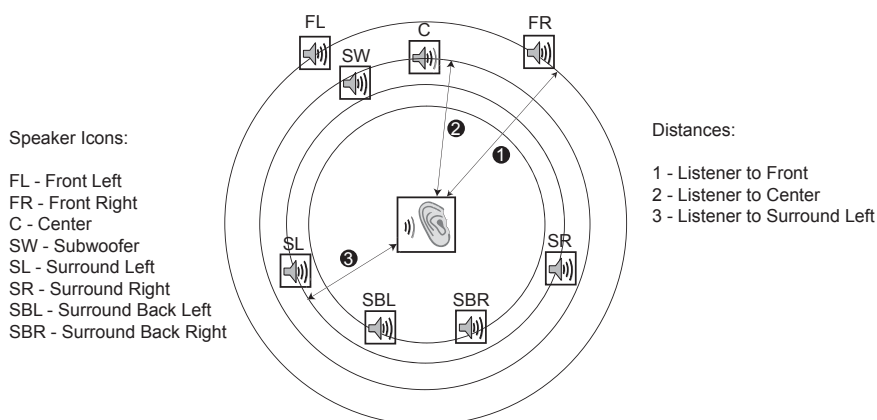

In the above diagram, measure the distance (in feet) from the primary listening position to the Front Left or Front Right Speaker. Enter the distance of the Front Speakers (❶ in the above picture) into the **Speaker Configuration** menu.

Next, measure the distance (in feet) from center speaker (❷) to the listening position. Move the cursor to highlight the Center speaker in the Channel Delay setup page, and enter the distance (as close as possible) in feet. Repeat for each speaker in the system (Center, Surround Left, Surround Right, Surround Back Left, Surround Back Right and Subwoofer) as available. The player will insert appropriate delay to make sure sound waves from different speakers arrive at the listener at the same time.

It is possible to independently set distances for each speaker. Speaker distances can be set to the actual spatial distance of the speakers.

If the channel delay settings cannot match your speaker configuration, please set all distances to the same and use your receiver/amplifier to set the channel delay.

- Trim:** The speaker trim level parameters sets the volume of each individual channel. Channel trim is generally not required since most A/V receivers have the capability to adjust channel trim and compensate for speaker sensitivity differences. However, if your receiver does not have such functions (many receivers do not support channel trim for their multi-channel analog inputs), you may adjust channel trim through the player. For most accurate results, it is recommended that you use test tones from a calibration disc, such as *Digital Video Essentials HD Basics*, and a SPL (Sound Pressure Level) meter. The trim level can be set to +/- 10dB in 0.5dB increments.

NOTE

- Increasing the **Trim Level** above 0dB may result in distortion if the original audio level is already high. When this occurs the waveform becomes clipped and audible distortion can be heard. In this situation, it is necessary to reduce the **Trim Level** until the distortion is removed. When using the **Trim Level** for speakers, it is recommended that you set the least sensitive speaker's **Trim Level** to 0dB, and set other speakers' **Trim Level** to negative values.
- Each speaker can be set to independent trim levels and there is no linked pair limitation.

Other Audio Processing Settings

In addition to **Speaker Configuration**, **Crossover Frequency** and **Dynamic Range Control** are audio processing settings that can be configured:

1. **Crossover:** Allows you to set the Bass Management kick-in frequency for all speakers. When the speaker size is set to **Small** in **Speaker Configuration** (see page 69), bass information below this frequency is not passed to the speakers to reduce possible distortion, and if the subwoofer is available, bass information will be redirected to the subwoofer. When all speaker sizes are set to **Large**, there is no Bass Management.
 - **40Hz / 50Hz / 60Hz / 70Hz / 80Hz / 90Hz / 100Hz / 110Hz / 120Hz / 130Hz / 140Hz / 150Hz / 160Hz / 200Hz / 250Hz** – These are the available crossover frequencies. You can press the **UP/DOWN ARROW** buttons and the **ENTER** buttons to select it. This option applies to all speakers (center front, surround, and surround back speakers). By default the crossover frequency is **80Hz**.
2. **Dynamic Range Control:** Allows you to set the Dynamic Range Compression (DRC). DRC can smooth out the sonic peaks and valleys common with wide-range digital audio. Enabling DRC may make low level audio more audible during low-level listening. Turning off DRC restores the sonic energy present in the original recording.
 - **Auto** – Plays at the dynamic range specified by the disc. This option applies to certain Blu-ray Discs only, which have DRC instructions encoded in the Dolby TrueHD audio tracks.
 - **On** – Turn on DRC for all Dolby and DTS audio formats. This option applies to all DVD and Blu-ray Discs.
 - **Off** – Turn off DRC.

NOTE

- Dynamic Range Compression is applied to the analog audio output and digital audio outputs (HDMI, Coaxial and Optical) when the audio format is set to PCM.

3. **DTS Neo:6 Mode:** Allows you to enable DTS Neo:6 audio processing and select the listening mode. DTS Neo:6 is a digital signal processing that can expand the original stereo source to 7.0 (L, R, C, L_s, R_s, L_R, R_R) or 7.1 (with Bass Management) surround.
 - **Music** – Enables DTS Neo:6 audio processing for stereo music sources.
 - **Cinema** – Enables DTS Neo:6 audio processing for digital TV box or stereo movie sources.
 - **Off** (default) – Turns off the DTS Neo:6 to keep the original audio quality.
4. **Output Volume:** Allows you to enable or disable the analog volume controls (also known as Variable Audio). The available options are:
 - **Variable** – Enables the analog volume control. Use the **VOL+/-** buttons on the remote to increase/decrease the analog audio output level (the maximum is 100).
 - **Fixed** – Disables the analog volume control. The **VOL+/-** buttons on the remote will no longer affect the analog audio output, and the volume level is fixed to 100.
5. **Power On Volume:** Allows you to set the initial audio volume level after power on. This option will be applied to the 7.1 audio outputs.
 - **Last** (default) – Power on with the previous volume level before the player was turned off. This choice is recommended for regular use.
 - **Custom** – Power on with your preferred volume level. You may use the **LEFT/RIGHT ARROW** buttons on the remote to decrease/increase the volume level. The default level is 40.

6. **Maximum Volume:** Allows you to set the maximum volume level. This option will be applied to the 7.1 audio outputs. You may use the LEFT/RIGHT ARROW buttons on the remote to decrease/increase the volume level. The default value is 100.
7. **A/V Sync** – Allows you to add a slight delay to the audio so it is synchronized to the video. You may use the LEFT/RIGHT ARROW buttons on the remote to decrease/increase the audio delay. The delay can be adjusted in 10ms steps and within the range of -100ms to +200ms. The delayed time will be applied to all output terminals including HDMI 1 and 2, Coaxial, Optical, and 7.1 outputs.

NOTE

- The negative adjustment values are for cancelling out the audio delay that the player automatically applies. Depending on the video source and the time it takes to process the video, the main decoder chip automatically applies an audio delay in order to optimize audio video synchronization. The negative manual settings reduce the automatic audio delay, while the positive manual settings apply additional delay. Any negative value setting beyond the player's automatic delay will be treated as completely cancelling the automatic delay. For example, if the "A/V Sync" value is manually set to -100ms and for the current video source the player applies a 70ms automatic audio delay, the final result is that the 70ms audio delay gets cancelled and the audio is not delayed at all. It is not possible to put audio ahead of video using this setting.
- For content sent through HDMI IN, the "A/V Sync" adjustment only works with positive values.

Device Setup

The **Device Setup** section of the **Setup Menu** system allows you to configure additional player options related to the hardware and control functions.

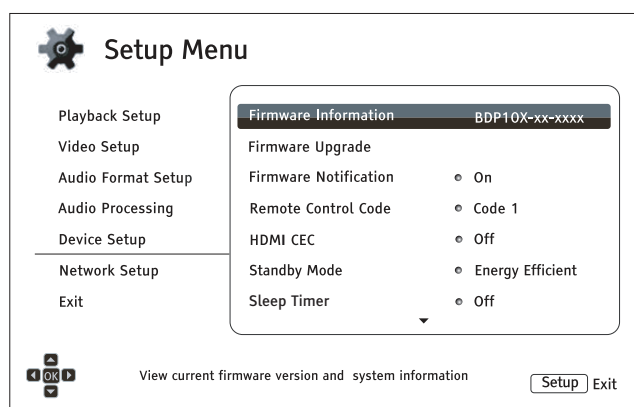

1. **Firmware Information:** Displays the currently installed firmware version.
2. **Firmware Upgrade:** Upgrades the player's firmware. This operation is only available when the Input Source is set to "BLU-RAY PLAYER" (see the INPUT button on page 8), and the playback is completely stopped or there is no disc loaded.

The firmware is the system software that controls the features and functions of the player. Since the Blu-ray Disc specifications are new and evolving, it is possible that a Blu-ray Disc manufactured after the player was manufactured uses certain new features of the Blu-ray Disc specifications. To ensure the best possible viewing experience, the player may need a firmware update from time to time. Please visit the OPPO Digital web site www.oppodigital.com to check for firmware updates and instructions on installing the updates.

There are three ways to upgrade the player's firmware:

- **Via USB** – You may download the firmware files from the OPPO Digital web site to a USB drive and then use the USB drive to upgrade the player. Please follow the instructions on the firmware download web page.
 - **Via Disc** – You may request a firmware upgrade disc from OPPO Digital or download a disc image from the OPPO Digital web site and burn an upgrade disc. Please follow the instructions that come with the upgrade disc.
 - **Via Network** – If the player has a working Internet connection (see pages 19 and 78), you may upgrade the player directly over the Internet. Please follow the instructions on your TV screen.
3. **Firmware Notification:** Allows you to set whether the player should automatically check for new firmware versions on the Internet server and notifies you about new firmware.
 - **On** – Checks for firmware updates automatically and notifies the user about new firmware. Requires a working network connection.
 - **Off** – Does not check for new firmware version automatically.
 4. **Remote Control Code:** The BDP-103D can respond to one of four sets of remote control codes. The default is "Code 1". If you have other OPPO products in the vicinity of the BDP-103D, the other products may respond to the BDP-103D remote control. To prevent this, you can select a different remote code. The available codes are:

- **Code 1** – OPPO disc player remote code is set to 1. This is the default remote code.
- **Code 2** – OPPO disc player remote code is set to 2. Use this code if you have other OPPO products placed close to the BDP-103.
- **Code 3** – OPPO disc player remote code is set to 3. Use this code if you have other OPPO products placed close to the BDP-103.
- **Alt. Code** – Alternative remote code. The alternative remote control code enables users to program their universal remote controls that come with TV, projector or A/V receiver to operate the OPPO player. If the universal remote control has a DVD player control function, please program it with the code for Toshiba, Philips, Magnavox, Marantz or Zenith DVD players. Since each brand of remote control may have several sets of codes, you may need to try several times using different codes to find a working code.

If you have selected a new remote code, you must set the remote control handset to use the same code. Please refer to the **Changing the Remote Code** section on page 10 of this manual for details. If you have selected **Alt. Code**, the supplied handset will not operate the player, and you must use a universal remote control with the properly configured code set.

5. **HDMI CEC**: Allows you to set the HDMI Consumer Electronics Control (CEC) mode. CEC is an optional HDMI feature that enables convenient remote control and automatic setup of consumer electronics over the HDMI connection. The remote control function allows you to use a single remote handset to operate multiple devices connected via HDMI. For example, you may use the TV remote to control playback of the Blu-ray Disc player. The automatic setup function can automatically turn on the TV and change to the proper input when you start playing a disc in the Blu-ray Disc player. It can also turn off the player automatically when you turn off the TV. The implementation and compatibility of this feature varies by device manufacturer. Each may only implement part of the features or add their own proprietary functions. The manufacturer-specific implementation of the HDMI CEC function is often given a proprietary name of "...Link" or "...Sync". The BDP-103 provides three HDMI CEC function modes for each of its HDMI outputs:
 - **HDMI 1** – HDMI CEC is enabled on HDMI 1 output. Use this mode if your other devices are compatible with the player.
 - **HDMI 1 (Limited)** – HDMI CEC is enabled on HDMI 1 output, but the BDP-103 will only respond to playback control commands. It will not respond or issue power on/off and input selection commands. Use this mode if you do not want the automatic setup function to turn on/off your devices.
 - **HDMI 2** – HDMI CEC is enabled on HDMI 2 output. Similar to **HDMI 1**.
 - **HDMI 2 (Limited)** – HDMI CEC is enabled on HDMI 2 output, but the BDP-103 will only respond to playback control commands. Similar to **HDMI 1 (Limited)**.
 - **Off** (default) – HDMI CEC feature is turned off on both HDMI output terminals. The player will not respond to HDMI CEC commands from other devices, nor will it setup other devices automatically.
6. **Standby Mode**: Allows you to choose between two standby modes. In **Energy Efficient** mode, the player consumes a minimal amount of power but takes more time to get ready for operation after being turned on. In **Quick Start** mode, the player can start up significantly faster at the expense of additional power consumption during the standby period.
 - **Energy Efficient** (default) – The player will take slightly longer to start up, but will consume less power in standby mode. This mode is recommended for regular use.

- **Quick Start** – The player takes less time to start up but consumes more power in standby mode. This mode is recommended if the player is used frequently, or if you need to supply power to a device connected to the player’s MHL port during the standby period.
7. **Sleep Timer:** Allows you to specify the amount of time before the player automatically turns itself off.
- **Off** (default) – The player will not turn itself off automatically.
 - **30/45/60/90/120 Min** – These are the available time increments (in minutes) you can choose before the player automatically shuts itself down. You can press the **UP/DOWN ARROW** buttons and the **ENTER** button to select the desired time. Once selected, the remaining minutes will be displayed to the right of the “Sleep Timer” option.
8. **Front Panel Brightness:** Allows you to control the display intensity of the front panel Vacuum Fluorescent Display (VFD) information window and the **OPEN/CLOSE** tray button backlight. If you feel that the display becomes a distraction to your enjoyment of the video, this option allows you to dim it or turn it off.
- **Standard** (default) – The VFD window and the **OPEN/CLOSE** tray button backlight are at full brightness.
 - **Dim** – The VFD window and the **OPEN/CLOSE** tray button backlight are at reduced brightness.
 - **Off** – The VFD window and the **OPEN/CLOSE** tray button backlight are turned off. In this mode, the display and backlight will resume momentarily if there is any user operation.
9. **Cache Media Info** (On/Off) : Allows you to set the online media file information caching option. This option can provide a better media file navigation experience by caching some of the media information in an “OPPO_Media_Info” folder created on the root directory of the connected USB drive.
- **On** (recommended) – The downloaded media information will be saved on the same USB hard disk or thumb drive as the media files for faster navigation.
 - **Off** – The downloaded media file information is not saved. Retrieving the media information from the internet may take some time and could slow down media file navigation.
10. **Persistent Storage:** Allows you to manage the persistent storage for BD-Video content. The persistent storage is a data storage area that holds additional content for *BonusView* and *BD-Live* features. The data will be kept even if you turn off the player. The following persistent storage management options are available:
- **Storage Device** – Allows you to select which storage device should be used as the persistent storage. The BDP-103 preserves about 1GB of internal flash memory that can be used for persistent storage. There are also three USB ports on the player that can accept a USB drive to be used as the persistent storage. You may choose from the following:
 - **Internal Flash** – Uses the internal flash memory for persistent storage.
 - **USB Drive** – Uses a USB drive for persistent storage. To meet the specification for *BD-Live*, a USB flash drive of 1GB or larger is required. A USB hard drive is not recommended.

NOTE

The new storage device choice becomes effective only after the player is restarted. Please make sure that you turn off the player and then turn it back on after changing the **Storage Device** option.

- **Space Used** – Displays the used space of the persistent storage. If too much space is used and the available space becomes too low, some Blu-ray Discs may not play properly.
 - **Erase Persistent Storage** – Erases the BD-Video data from the persistent storage or initializes a USB drive so it can be used for persistent storage.
11. **Netflix**: Allows you to de-activate your Netflix account.
- **Netflix ESN** – Displays the Netflix ESN (Electronic Serial Number) for your player.
 - **De-activate Netflix** – De-activates the Netflix account on your player. Once de-activated, you have to go to the **Home Menu**, select **Netflix**, and go through the activation procedure again to be able to access Netflix from your player.
12. **VUDU**: Allows you to de-activate your VUDU HD Movies account.
13. **Settings Management**: Allows you to backup or restore the player settings. This option affects the settings in the **Setup Menu**. It does not export/import private information such as Wi-Fi password, internet application activations, or account information.
- **Backup Settings** – Backup the player settings to the first detected USB storage device. The player will create a new configuration file named “[player model].cfg”, such as “BDP103.cfg”, and the settings will be stored in binary format which can only be accessed by OPPO technical support.
 - **Restore Settings** – Restore the player’s settings from external USB storage. The player will access the first detected USB storage device for the configuration file. To avoid any confusion, we recommend only connect one USB storage device to the player at this time.
14. **Reset Factory Defaults**: To reset all settings to the factory default value. This operation also set **BD-Live Network Access** to be **Off** (details on page 77) and performs **Erase Persistent Storage** (details on page 75). However, the remote control code will not be reset. This operation is only available when the playback is completely stopped or when there is no disc loaded.
- **Erase Accounts and Settings** (default) – Resets all settings to the factory default value and remove all application activations and account information, such as your Netflix and VUDU accounts.
 - **Erase Settings** – Resets all settings to the factory default value, but keeps the application activations and account information.

Network Setup

The **Network Setup** section of the **Setup Menu** system allows you to configure the player's network connection, test the connection, and enable or disable BD-Live access.

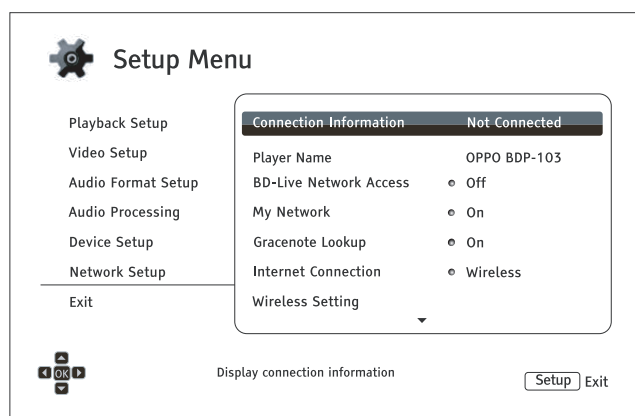

1. **Connection Information:** Displays the current internet connection information, such as connection type, IP address, Ethernet MAC, Wireless MAC, etc.
2. **Player Name:** Enter and display the player's identification name as it is displayed on local network sharing products. To change it, press the **ENTER** button to bring the soft keyboard. The name can contain maximum 12 characters including spaces.
3. **BD-Live Network Access:** Used to permit or restrict BD-Live content access.
 - **On** – BD-Live access is permitted.
 - **Limited** – BD-Live access is permitted only for content that has a valid content owner certificate. Internet access is prohibited if the BD-Live contents does not have a certificate. This option ensures that you are accessing only authentic content, although it may block your access to smaller independent content providers.
 - **Off** (recommended) – BD-Live access is prohibited.
4. **My Network:** Configures the My Network (in-home media sharing) client. My Network enables the player to stream audio, video, and photos from media servers within the home network.
 - **On** (default) – Enables local network streaming. A broadband internet connection is required (details on page 19), and special hardware/software configurations are required (see In-home Network Media Sharing on page 41). The available media servers are listed inside the **Network** option of the **Home Menu** (details on page 42).
 - **Off** – Disables local network streaming. No media servers will be shown in the **Network** menu, and a warning message will pop up once you try to enter the **Network** menu.
5. **Gracenote Lookup:** Allows you to access the Gracenote online database for additional media information such as Disc Title, Genre, Year, Album, Artist and Cover Art.
 - **On** (default) – Enables the Gracenote service and allows the player to look up media information and cover art from the Gracenote database. A broadband internet connection is required (details on page 19).
 - **Off** – Disables the Gracenote service.

6. **Internet Connection:** Allows you to select the internet connection type.

- **Ethernet** (default) – Connect to the internet through an Ethernet cable. Please refer to the connection instructions on page 19. Selecting this will make the **Wireless Setting** option gray and un-selectable.
- **Wireless** – Connect to the internet through the external wireless adaptor. Please refer to the connection instructions on page 20. Choosing **Wireless** will start the **Wireless Setup Assistant**, and will also make the **Wireless Setting** option in the next row selectable.
- **Off** – Internet access is prohibited. This will make all the remaining options in the **Network Setup** screen gray and un-selectable.

7. **Wireless Setting** – Start the **Wireless Setup Assistant**. You can start the **Wireless Setup Assistant** by selecting the **Wireless Setting** option, or by selecting **Wireless** in **Internet Connection** menu. The procedure is described as follows:

The player first searches for the last successful wireless settings. If they exist, a message will pop up to remind you.

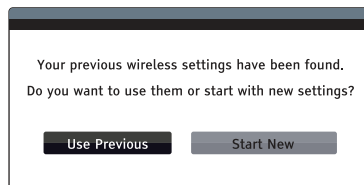

- **Use Previous** – Uses the last successful wireless settings. A summary of the previous wireless settings will display, showing information such as the SSID (network name), Security Mode and Security Key (password).

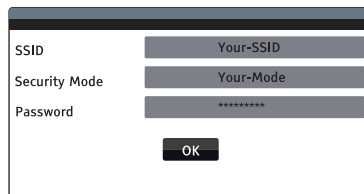

After verifying the previous settings, the player will test the connection and display the results.

- **Start New** – Creates a new wireless configuration. The BDP-103 supports three wireless configuration methods:

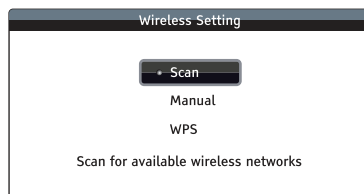

- **Scan** – Scans for an available wireless network. The player automatically scans for any available wireless networks and displays the search results in a window. You can press the **UP/DOWN ARROW** buttons to highlight a network and then press the **ENTER** button to select it. If this network is secured, you will need to input the security key using the remote control. The player will then test the connection and display the results.

- **Manual** – Allows you to manually enter the information for a wireless network. You need to use the remote control to input the SSID, select the Security Mode and input the Security Key. The player will then test the connection and display the results.
- **WPS** – Starts the Wi-Fi Protected Setup. The BDP-103 supports the WPS standard to provide an easy and secure establishment of a wireless home network. You may choose from the following setup options:

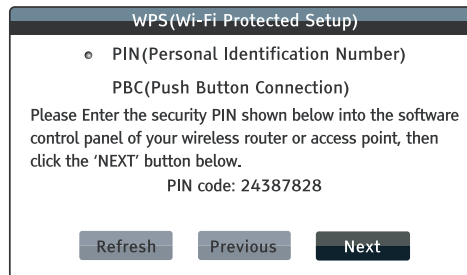

- ✓ **PIN** – Configures the WPS using a Personal Identification Number. The BDP-103 will generate a PIN code and you will need to input it into the software control panel of your wireless router or access point. Please follow the on-screen instructions.
- ✓ **PBC** – Configures the WPS using Push Button Control. You need to push a PBC button on your wireless router or access point to initiate the wireless connection. Please follow the on-screen instructions.

NOTE

SSID is short for Service Set Identifier. It is an identifier for each wireless router or access point, and is also referred as a **network name**.

WPS is short for Wi-Fi Protected Setup (WPS). It is the latest standard for easy and secure wireless home network configuration. It is also named **Wi-Fi Simple Config**. To use WPS, a WPS compatible router or access point is required.

8. IP Setting: Determines how the player obtains its IP address.

- **Auto (DHCP)** – The player automatically obtains its IP address information using DHCP (Dynamic Host Configuration Protocol). This is the default setting. In most cases, automatic IP configuration should be used.
- **Manual** – Allows you to manually enter the numeric IP address. Set the IP configuration manually only when the router has no DHCP server functions or when the router's DHCP server function is disabled. For more information on how to manually configure the Internet connection and what values to use, please consult your broadband router/modem instruction manuals or call your Internet service provider.
 - **Internet Connection** – Depending on the setting in **Internet Connection**, this can be either "Wireless" or "Ethernet".
 - **IP Address:** The Internet Protocol address of the player. When **IP Setting** is set to **Auto (DHCP)**, the value displayed here is obtained using DHCP and cannot be changed.

- **Subnet Mask:** Each IP address has an associated subnet mask. It is used by the player to decide whether to route network traffic through the router or directly to another device on the same network. When **IP Setting** is set to **Auto (DHCP)**, the value displayed here is obtained using DHCP and cannot be changed.
 - **Gateway:** The IP address of the router. It is also called “default gateway” or “default router”. When **IP Setting** is set to **Auto (DHCP)**, the value displayed here is obtained using DHCP and cannot be changed.
 - **DNS 1:** The IP address of the primary DNS (Domain Name System) server. DNS is the mechanism used to translate human-readable addresses (such as www.oppodigital.com) to numeric IP addresses. When **IP Setting** is set to **Auto (DHCP)**, the value displayed here is obtained using DHCP and cannot be changed.
 - **DNS 2:** The IP address of the secondary DNS server. When **IP Setting** is set to **Auto (DHCP)**, the value displayed here is obtained using DHCP and cannot be changed.
9. **Proxy Setting:** Allows you to configure the proxy server settings. The proxy server works as an intermediary for network communication between clients and other servers, which can provide benefits like security, anonymity, or even circumvention of regional restrictions.
- **On** – Accesses the Internet via a proxy server.
 - **Proxy Host:** Input the proxy host name using the remote control.
 - **Proxy Port:** Input the proxy host port number using the remote control.
 - **Off** (default) – Disables the use of a proxy server.
- We recommend keeping **Proxy Setting** set to **Off**, unless you have a working Proxy Host and Proxy Port, and have to use the proxy server in order to access the internet.
10. **Connection Test:** Allows you to test the Internet connection. It is recommended that you test the connection when you initially connect the player to the Internet, or whenever changes to **Connection Method**, **Wireless Setting**, **IP Setting** and other network parameters are made.

REFERENCES

Useful Notes

- In order to prolong the life of your player, it is recommended that you wait at least 30 seconds before you power it on after switching it off.
- Remove discs and turn the power off after operation.
- Some functions of the player may not be applicable to certain discs.
- Some discs with special features may not be fully supported by the player. This is not a malfunction of the unit.
- In the case of player malfunction, please turn it off, wait for 30 seconds and turn it back on. If the problem still exists, please follow the troubleshooting instructions or contact an OPPO service center.

Troubleshooting

Use this chart to resolve general operational problems. If there are any problems that you cannot resolve, please contact your OPPO service center.

Symptom	Possible Cause	Solution	Reference Page
No sound	Audio cable is not properly connected	Check audio cable, and then reconnect if necessary.	11–17
	Mute is activated	Press the MUTE button to cancel the mute.	28
	Volume is too low	Press the VOL + button to increase the volume to 100.	27
	SACD is played and the audio connection is coaxial or optical digital audio	This is not supported due to copyright restrictions of SACD. Please use the analog or HDMI audio output. Alternatively, you may set SACD Priority to CD mode and the player will play the CD layer.	17, 51
	DVD-Audio is played and the audio connection is coaxial or optical digital audio	This is not supported due to copyright restrictions of DVD-Audio. Please use the analog or HDMI audio output. Alternatively, you may switch to the DVD-Video playback mode.	17, 51
No picture	Video cable is not properly connected	Check video cable; reconnect if necessary.	11–15
	TV input is not correctly selected	Select the input to which the player is connected.	
	“Pure Audio” mode engaged	Press the PURE button to cancel this mode.	38
	Video output format is not support by the TV	Select a proper output resolution that is supported by your TV.	31
	Video system is not supported by the TV	When playback is completely stopped, set the correct TV System in the Setup Menu.	54
No color	Video system is not supported by the TV	When playback is completely stopped, set the correct TV System in the Setup Menu.	54
	Saturation set too low	Check the saturation setting on TV and player.	58
	Incorrect video output port	If using “DIAG.” output, check that the cable is not incorrectly plugged into a component video jack.	13
Incorrect color	Incorrect color space setting	If using HDMI for video output, check the color space setting on the TV and player.	59
Picture rolling or split picture	Video system is not supported by the TV	When playback is completely stopped, set the correct TV System in the Setup Menu.	54
“No Disc” or “Unknown Disc” error	No disc or incompatible disc loaded in player	Eject disc and check.	24
	Dirty disc recording surface	Eject the disc and clean any dirt or fingerprints.	4
	Disc not properly loaded	Eject disc and make sure the label side is facing up and the record side is facing down.	24
	Condensation on the Laser pick-up head	Turn on the player, eject the disc and leave the player on for about an hour.	2

REFERENCES

Remote control failure	Remote control is out of range	Use the remote control within the effective range.	9
	Low battery	Replace the batteries	9
	Incorrect remote control code	Open the disc tray. Aim the remote at the player. Press and hold the ENTER button on the remote for 5 seconds to set the remote code.	10
Temporary function failure	Scratched or damaged disc is used	Replace the disc.	24
	Some functions are not available during playback	Stop playback completely, then try again.	24
	Interference from other devices	Identify interference by turning off other devices, and then relocate or replace the offending device	2
Some Setup Menu items are grayed out	Some setup options cannot be changed while a disc is playing. Some setup options may be mutually exclusive with other setup options.	Fully stop playback, eject the disc and try the Setup Menu again.	49
"Connection Test" fails	No internet connection.	Verify that your router has a connection to the internet. Try power cycling the modem and router. Try a direct Ethernet connection if possible.	19, 20, 78
"Network" shows no server	No network connection. Media server not properly configured. Connected to wrong network.	Verify that other network features are functional on the device (YouTube, Netflix, etc.) If the network issues are isolated to the "Network" feature, consult your media server's documentation to ensure proper configuration.	19, 41
Internet streaming fails	Poor wireless signal. Incorrect network settings.	Verify that the player is communicating with the router (Setup Menu > Network Setup > Connection Information). Change the DNS server information (Google Public DNS / OpenDNS). If connecting wirelessly, verify that your connection strength is > 50%. If it is lower, connect via Ethernet or use the USB extension cable to move the Wi-Fi adapter closer to your router.	19, 42

Specifications

Designs and specifications are subject to change without notice.

Disc Types*	BD-Video, Blu-ray 3D, DVD-Video, DVD-Audio, AVCHD, SACD, CD, HDCD, Kodak Picture CD, CD-R/RW, DVD±R/RW, DVD±R DL, BD-R/RE
BD Profile	BD-ROM Version 2.5 Profile 5 (also compatible with Profile 1 Version 1.0 and 1.1)
Internal Storage	1GB (Actual space available for persistent storage varies due to system usage)
Output	Analog Audio: 7.1ch, 5.1ch, stereo. Coaxial/Optical Audio: up to 2ch/192kHz PCM, Dolby Digital, DTS. HDMI Audio: up to 7.1ch/192kHz PCM, up to 5.1ch DSD, Dolby Digital, Dolby Digital Plus, Dolby TrueHD, DTS, DTS-HD High Resolution, DTS-HD Master Audio. HDMI Video: 480i/480p/576i/576p/720p/1080i/1080p/1080p24/4Kx2K, 3D frame-packing 720p/1080p24.
Input	HDMI Audio: up to 5.1ch/192kHz or 7.1ch/96kHz PCM, Dolby Digital, Dolby Digital Plus, DTS, AAC. HDMI Video: 480i/480p/576i/576p/720p/1080i/1080p/1080p24/1080p25/1080p30, 3D frame-packing 720p/1080p24. MHL Audio: up to 5.1ch/192kHz PCM, Dolby Digital, Dolby Digital Plus, DTS. MHL Video: 480i/480p/576i/576p/720p/1080i/1080p24/1080p25/1080p30, 3D frame-packing 720p/1080p24.
Audio Characteristics**	Frequency: 20Hz – 20kHz (±0.05dB), 20Hz – 96kHz (-4.5dB ~ +0.05dB) Signal-to-Noise Ratio: >115dB (A-weighted) THD+N: < 0.006% (1kHz at 0dBFS, 20kHz LPF)
General Specification	Power Supply: ~100V – 240V, 50/60Hz AC Power Consumption: 35W (Standby: 0.5W in Energy Efficient Mode) Dimensions: 16.8 x 12.2 x 3.1 inches (430mm x 311mm x 79mm) Mass: 10.8 lbs (4.9kg)
Operating Temperature	41°F – 95°F 5°C – 35°C
Operating Humidity	15% – 75% No condensation

* Compatibility with user-encoded contents or user-created discs is on a best effort basis with no guarantee due to the variation of media, software and techniques used.

**Nominal specification.

User Manual Updates Online

An updated version of the User Manual may be available online at the OPPO Digital web site (www.oppodigital.com). To read or download the latest online User Manual, Click on the BDP-103 product, and open its “Support” tab.

Occasional updates are needed to reflect new features added to the player since the User Manual was printed. As future firmware updates bring in new features and functions, the online version of the User Manual will be updated accordingly.

Language Code List

Code	Language Name
6565	Afar
6566	Abkhazian
6570	Afrikaans
6577	Amharic
6582	Arabic
6583	Assamese
6588	Aymara
6590	Azerbaijani
6665	Bashkir
6669	Byelorussian
6671	Bulgarian
6672	Bihari
6678	Bengali, Bangla
6679	Tibetan
6682	Breton
6765	Catalan
6779	Corsican
6783	Czech
6789	Welsh
6865	Danish
6869	German
6890	Bhutani
6976	Greek
6978	English
6979	Esperanto
6983	Spanish
6984	Estonian
6985	Basque
7065	Persian
7073	Finnish
7074	Fijian
7079	Faroese
7082	French
7089	Frisian
7165	Irish
7168	Scots Gaelic
7176	Galician
7178	Guarani
7185	Gujarati
7265	Hausa
7273	Hindi
7282	Croatian

Code	Language Name
7285	Hungarian
7289	Armenian
7365	Interlingua
7378	Indonesian
7383	Icelandic
7384	Italian
7387	Hebrew
7465	Japanese
7473	Yiddish
7487	Javanese
7565	Georgian
7575	Kazakh
7576	Greenlandic
7577	Cambodian
7578	Kannada
7579	Korean
7583	Kashmiri
7585	Kurdish
7589	Kirghiz
7665	Latin
7678	Lingala
7679	Laotian
7684	Lithuanian
7686	Latvian, Lettish
7771	Malagasy
7773	Maori
7775	Macedonian
7776	Malayalam
7778	Mongolian
7779	Moldavian
7782	Marathi
7783	Malay
7784	Maltese
7789	Burmese
7865	Nauru
7869	Nepali
7876	Dutch
7879	Norwegian
7982	Oriya
8065	Punjabi
8076	Polish
8083	Pashto, Pushto

Code	Language Name
8084	Portuguese
8185	Quechua
8277	Rhaeto-Romance
8279	Romanian
8285	Russian
8365	Sanskrit
8368	Sindhi
8372	Serbo-Croatian
8373	Singhalese
8375	Slovak
8376	Slovenian
8377	Samoan
8378	Shona
8379	Somali
8381	Albanian
8382	Serbian
8385	Sundanese
8386	Swedish
8387	Swahili
8465	Tamil
8469	Telugu
8471	Tajik
8472	Thai
8473	Tigrinya
8475	Turkmen
8476	Tagalog
8479	Tonga
8482	Turkish
8484	Tatar
8487	Twi
8575	Ukrainian
8582	Urdu
8590	Uzbek
8673	Vietnamese
8679	Volapuk
8779	Wolof
8872	Xhosa
8979	Yoruba
9072	Chinese
9085	Zulu

Gracenote Terms of Use

This application or device contains software from Gracenote, Inc. of Emeryville, California (“Gracenote”). The software from Gracenote (the “Gracenote Software”) enables this application to do disc or file identification and obtain music-related information, including name, artist, track, and title information (“Gracenote Data”) from online servers or embedded databases (collectively, “Gracenote Servers”) and to perform other functions. You may use Gracenote Data only by means of the intended End-User functions of this application or device.

This application or device may contain content belonging to Gracenote’s providers. If so, all of the restrictions set forth herein with respect to Gracenote Data shall also apply to such content and such content providers shall be entitled to all of the benefits and protections set forth herein that are available to Gracenote.

You agree that you will use Gracenote Data, the Gracenote Software, and Gracenote Servers for your own personal non-commercial use only. You agree not to assign, copy, transfer or transmit the Gracenote Software or any Gracenote Data to any third party. **YOU AGREE NOT TO USE OR EXPLOIT GRACENOTE DATA, THE GRACENOTE SOFTWARE, OR GRACENOTE SERVERS, EXCEPT AS EXPRESSLY PERMITTED HEREIN.**

You agree that your non-exclusive license to use the Gracenote Data, the Gracenote Software, and Gracenote Servers will terminate if you violate these restrictions. If your license terminates, you agree to cease any and all use of the Gracenote Data, the Gracenote Software, and Gracenote Servers. Gracenote reserves all rights in Gracenote Data, the Gracenote Software, and the Gracenote Servers, including all ownership rights. Under no circumstances will Gracenote become liable for any payment to you for any information that you provide. You agree that Gracenote may enforce its rights under this Agreement against you directly in its own name.

The Gracenote service uses a unique identifier to track queries for statistical purposes. The purpose of a randomly assigned numeric identifier is to allow the Gracenote service to count queries without knowing anything about who you are. For more information, see the web page for the Gracenote Privacy Policy for the Gracenote service.

The Gracenote Software and each item of Gracenote Data are licensed to you “AS IS.” Gracenote makes no representations or warranties, express or implied, regarding the accuracy of any Gracenote Data. Gracenote reserves the right to delete data from the Gracenote Servers or to change data categories for any cause that Gracenote deems sufficient. No warranty is made that the Gracenote Software or Gracenote Servers are error-free or that functioning of Gracenote Software or Gracenote Servers will be uninterrupted. Gracenote is not obligated to provide you with new enhanced or additional data types or categories that Gracenote may provide in the future and is free to discontinue its services at any time.

GRACENOTE DISCLAIMS ALL WARRANTIES EXPRESS OR IMPLIED, INCLUDING, BUT NOT LIMITED TO, IMPLIED WARRANTIES OF MERCHANTABILITY, FITNESS FOR A PARTICULAR PURPOSE, TITLE, AND NON-INFRINGEMENT. GRACENOTE DOES NOT WARRANT THE RESULTS THAT WILL BE OBTAINED BY YOUR USE OF THE GRACENOTE SOFTWARE OR ANY GRACENOTE SERVER. IN NO CASE WILL GRACENOTE BE LIABLE FOR ANY CONSEQUENTIAL OR INCIDENTAL DAMAGES OR FOR ANY LOST PROFITS OR LOST REVENUES.

© 2012. Gracenote, Inc. All Rights Reserved.

LIMITED WARRANTY

OPPO Digital, Inc. Limited Two Years Warranty

Your OPPO product has been manufactured to precise standards, and with rigid quality control through every process of manufacturing. It is warranted by OPPO DIGITAL, INC. against defective workmanship or materials for two (2) full years from the original date of purchase. This warranty applies only to OPPO brand products imported or manufactured by OPPO Digital, Inc. and sold to the original consumer purchaser in the U.S.A. or Canada by either OPPO Digital, Inc. or an OPPO authorized reseller. This warranty does not apply to OPPO brand products imported and sold by unauthorized dealers, distributors, or other sellers. This warranty does not apply to products purchased or shipped outside of the U.S.A. and Canada. OPPO Digital, Inc. may at its sole discretion, refuse to honor the warranty of any such unauthorized product that may be presented for service.

Warranty service can only be performed by OPPO Digital, Inc. or an OPPO authorized service center. The original dated bill of sale must be presented upon request as proof of purchase.

OPPO Digital, Inc. will, at its option and at no charge as stipulated herein, repair or replace product which is returned either in person or postpaid and insured to an OPPO service center, with new or reconditioned parts or products. Replacement parts and products assume the remaining original warranty, or ninety (90) days, whichever is longer.

This limited warranty covers noncommercial use of this product, and shall not apply to the following, including, but not limited to: applications and uses for which this product was not intended; altered product or serial numbers; cosmetic damage or exterior finish; batteries and cable accessories; accidents, abuse, neglect, fire, water, lightning or other acts of nature; incorrect electrical line voltage, fluctuations and surges; failure to follow operating or maintenance instructions. OPPO Digital, Inc. does not warrant uninterrupted or error-free operation of the product. This limited warranty shall not extend to anyone other than the original purchaser of the product. It is nontransferable and states your exclusive remedy.

THE FOREGOING WARRANTY IS THE ONLY WARRANTY WITH RESPECT TO THE PRODUCT AND OPPO DIGITAL, INC. MAKES NO OTHER WARRANTY WHATSOEVER, EXPRESS OR IMPLIED, REGARDING THE PRODUCT INCLUDING MERCHANTABILITY AND FITNESS FOR A PARTICULAR PURPOSE. IN NO EVENT WILL OPPO DIGITAL, INC. OR ITS AUTHORIZED RESELLERS BE LIABLE FOR INCIDENTAL, CONSEQUENTIAL OR SPECIAL DAMAGES, EVEN IF SUCH DAMAGES RESULT FROM NEGLIGENCE OR OTHER FAULT.

Some states do not allow limitation on how long an implied warranty lasts, or the exclusion or limitation of incidental or consequential damages, so the above limitations or exclusions may not apply to you. This warranty gives you specific legal rights, and you may also have other rights which vary from state to state.

TO REGISTER YOUR PURCHASE FOR WARRANTY, please visit the following Web site:

<http://www.oppodigital.com/registration.asp>

TO OBTAIN WARRANTY SERVICE, please follow these instructions:

- Contact OPPO customer service via email at service@oppodigital.com or by phone at (650) 961-1118 with details of the defect claimed, product model, serial number, date and place of the original purchase.

- If it is determined that your product needs service, a Return Merchandise Authorization (RMA) number will be issued to you along with return instructions and address of an OPPO service center.
- Pack the product securely, preferably in the original packaging, with your assigned RMA number marked clearly on the outside of the package. Send the package postpaid and insured to the OPPO service center to obtain warranty service.

Thank you for choosing OPPO. Your satisfaction is our highest priority.

OPPO Digital, Inc.
2629 Terminal Blvd, Suite B
Mountain View, CA 94043, U.S.A.
www.oppodigital.com
service@oppodigital.com
(650) 961-1118

51977598

V1.8

oppo®

www.oppodigital.com