



# Instruction Sheet

## Electronic Ball Valve (EBV) Zone Valve

102-111

SUPERSEDES: 102-111, Dated August 1, 2003

EFFECTIVE: June 1, 2006

Plant ID# 001-1011

### Application:

Taco Electronic Ball Valve (EBV) Zone Valves provide on-off, normally open or normally closed control in closed hot water systems. The valves can be used in a wide variety of heating applications, primarily designed for use with fan coils, radiators, convectors, air handlers and radiant applications. Refer to the Product Specifications section for choosing the correct style valve for your application.

### The Energy Storage Principle:

The Taco Electronic Ball Valve (EBV) Zone Valve is a gear driven, capacitor powered valve. EBV technology replaces the typical spring (mechanical energy storage device) with a Prostar Capacitor (electronic energy storage device) for returning the valve to its normal position. In addition, we have replaced the typical synchronous AC motor with a high torque, high efficiency and highly reliable miniature motor. All functions of the Zone Valve's operation are monitored on board by a powerful microprocessor. A non-contact optical sensor (electronic eye) monitors the valve's position at all times. In the event of a loss of power to the valve, the EBV has a built-in override button located on the top of the operator for manual operation of the valve. As soon as power is restored the valve automatically finds it's correct operating position, even if the ball has been moved using the manual override.

### Ease of Installation / Operation:

The EBV is the most technologically advanced zone valve ever made. It's also simple to install and operate. The valve can be installed in any direction, in any orientation. Based on the success of Taco 570 zone valve, the EBV utilizes a dependable  $\frac{1}{4}$  turn one-handed twist lock for operator removal (see figure C). We then went a step further, allowing the operator to be mounted to the valve body in either direction (see figure A), great for those tight baseboard jobs. Snap-in quick connects on the back of the valve make for a secure and fast hook-up. A green LED light shows full functionality of the valve's operation and thermostat status. As noted above, under a no power situation the manual override button located on the top of the valve allows the ball to be rotated to any position and is also marked with an arrow to indicate the position of the valve.

### Valve Installation:

1. Valve body may be installed in any position, in any orientation (see Figure A).
2. Before mounting body, refer to Figure B and Dimensions Section for clearances.

Figure A

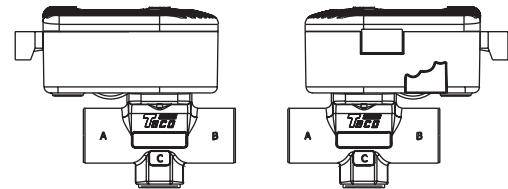

Two Position Head Placement.  
Universal Body Placement.  
May be installed in any position, any orientation.

Figure B

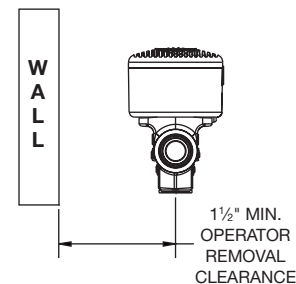

**WARNING: Operator must be removed from the valve body before soldering. Ball valve must be in the full open position before soldering. Valve shipped in the closed position.**

3. Use of a solder with a melting point below 600°F is recommended. Do not overheat! Make sure the ball valve is in the FULL OPEN position during soldering. Direct flame tip away from the center of the valve. Cool valve quickly with a wet rag.
4. Solder build-up on the ball valve may prevent proper opening and closing of the valve. Rotate the manual operation button several times to loosen any possible build-up.
5. Valve body can be submerged for leak testing before the operator is attached.

### Operator Installation / Wiring:

1. Valve operator may be attached to the valve body in either direction (see Figure A).
2. Operator removal: Remove valve operator prior to soldering by rotating the operator counterclockwise approximately 30 degrees and lifting upward approximately  $\frac{3}{4}$ " (see Figure C).

**Figure C: Operator Removal**

**Step 1**

Rotate actuator counter clockwise approximately 30 degrees

**Step 2**

Move actuator upward  $\frac{3}{4}$ " to disengage

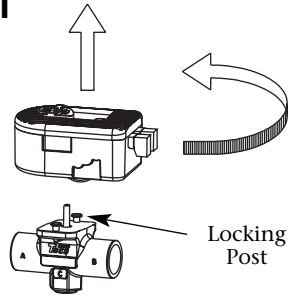

- To re-assemble operator to valve body: Position operator such that the "D" shaped valve stem aligns properly with the "D" shaped operator drive cavity (Note: The "D" shaped stem design allows for correct insertion every time). Next, slide valve stem into operator cavity and rotate until the operator slips over the valve's locking posts (see Figure C), once the operator is flush with valve body, turn operator clockwise and lock into position.
- Wire valve in accordance with system requirements, see wiring diagrams.
- The plug-in quick connects can be disconnected from the valve operator for ease of wiring. Insert the corresponding wire into the quick connects (see wiring diagrams) and tighten by turning the screw.
- On a 24v system do not jumper power/motor (24 VAC) connection terminals, even temporarily. This may cause damage to the thermostat's heat anticipator.

**Mode of Operation, Start-Up:**

- Upon initial field installation the capacitor requires a full charge, approximately 30 seconds before the valve starts to turn. Do not disconnect power to the actuator for at least 1 minute after valve turns.
- When the capacitor is charging the green LED light will FLASH.

- Once the capacitor is charged the green LED will stop flashing but remain ON, at this point the valve's operator will rotate the ball valve until it finds its "home" (the valves position when the thermostat is calling). The "home" position, either open or closed, is dependent on the style of valve purchased (either normally opened or normally closed).

NOTE: As the valve finds its "home" it may need to travel almost 180°, depending on the initial ball position. If it rotates past a 90° point it will close the end switch (T T terminals) to verify connection. This may make it seem as if the device (i.e. boiler) connected to the end switch terminals has short cycled while the valve finds its "home". This will **only** occur once on initial start-up.

- Once the valve finds its "home" the green LED will remain ON as long as the thermostat is calling.
- Once the thermostat is satisfied the green LED will turn OFF and the Prostar Capacitor will discharge some of its stored energy to rotate the valve 90° into its normal position. For example: If the actuator is an NC (normally closed) version, the operator would open the valve when the thermostat calls. Once the thermostat is satisfied the operator would then rotate the valve 90° to its normally closed position.

**Mode of Operation:**

- When the thermostat calls, the green LED will start to FLASH for a short period of time as the Prostar Capacitor completely refills its charge.
- The green LED will then turn ON and the operator will rotate the valve 90° into position.
- The green LED will stay ON as long as the thermostat is calling.
- Once the thermostat is satisfied, the green LED will turn OFF and the valve will rotate 90° to its normal position.

**WARNING: Do not use zone valves on indirect water heaters without a tempering device.**

**Flow Coefficients and Maximum Close-Off Pressure:**

VALVE SIZE	Cv (Kv)/Ft. of PIPE EQUIV.*	CLOSE-OFF PSI (kPa)
1/2"	4.9 (4.3) / 9.5	0-125 psi (0-862 kPa)
3/4"	10.3 (8.9) / 8.4	0-125 psi (0-862 kPa)
1"	8.9 (7.7) / 47.4	0-125 psi (0-862 kPa)

\* At 4' per second (max. recommended residential flow rate).

**Product Specifications:**

Maximum Operating Pressure:	300 PSI (2,100 kPa)
Maximum Shutoff Pressure:	125 PSI (875 kPa)
Fluid Temperature Range:	20° to 240°F, (-7° to 115°C) @ 135°F (57°C) ambient Installation must be in a non-condensing application.
Service:	Closed systems Hot Water, up to 50% Glycol
Ball Rotation Speed:	Full Open to Full Close (90° turn), 4 seconds Full Close to Full Open (90° turn), 6 seconds
Seat Leakage:	Drop-Tight Close-Off
Electrical Rating:	24 VAC, 60 HZ, 0.54 Amps Do not exceed number of valves per transformer rating. Example: Do not use more than 12 zone valves per 40VA transformer.
Power Consumption, Charging:	12.84 Watts, 0.54 Amps Max
Power Consumption, Power On:	1.44 Watts, 0.06 Amps Max
Heat Anticipator Setting:	0.5 Amps
End Switch Rating:	3 Amps @ 24 VAC

**Materials of Construction, Actuator:**

Body:	High Performance Engineered Polymer
Gears:	High Performance Internally Lubricated Engineered Polymer

**Materials of Construction, Valve:**

Body:	Forged Bronze
Stem:	Brass
Press Ring:	Brass
Ball:	Brass (Chrome Plated)
Seat:	Modified Teflon
O-rings:	EPDM

**Dimensions:**

VALVE SIZE	A	B	C	E	F	G	WEIGHT (valve + actuator)
1/2"	3"	2 3/8"	3 9/16"	2 9/16"	3 1/8"	1 9/16"	1.15 lbs
3/4"	3"	2 3/8"	3 3/4"	2 5/8"	3 1/8"	1 9/16"	1.20 lbs
1"	3"	2 3/8"	3 11/16"	2 5/8"	3 1/8"	1 9/16"	1.55 lbs

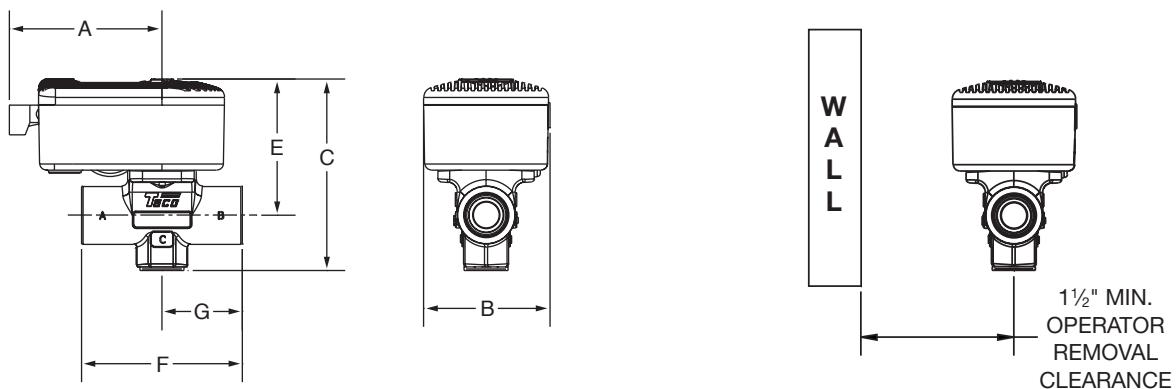

**“QUICK ORDER” PART NUMBERS**

- E050C2-1 > 1/2" 2-Way, Sweat, 24 VAC, Normally Closed, 4 Input Quick Connects
- E075C2-1 > 3/4" 2-Way, Sweat, 24 VAC, Normally Closed, 4 Input Quick Connects
- E100C2-1 > 1" 2-Way, Sweat, 24 VAC, Normally Closed, 4 Input Quick Connects
- E050T2-1 > 1/2" 2-Way, Threaded, 24 VAC, Normally Closed, 4 Input Quick Connects
- E075T2-1 > 3/4" 2-Way, Threaded, 24 VAC, Normally Closed, 4 Input Quick Connects
- E100T2-1 > 1" 2-Way, Threaded, 24 VAC, Normally Closed, 4 Input Quick Connects

# Electronic Ball Valve (EBV) Zone Valve Wiring Diagrams

**WARNING: Wiring connections must be made in accordance with all applicable electrical codes.**

**CAUTION: To prevent electrical shock, disconnect electric power to system at main fuse or circuit breaker box until installation is complete. When a service switch is installed, more than one disconnect switch may be required to deenergize this device for servicing.**

**Simplified Internal Schematic:**

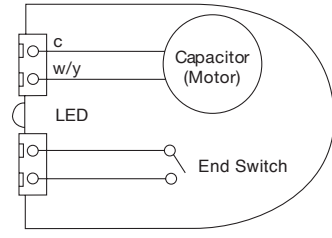

**Typical EBV Zone Valve Wiring:**

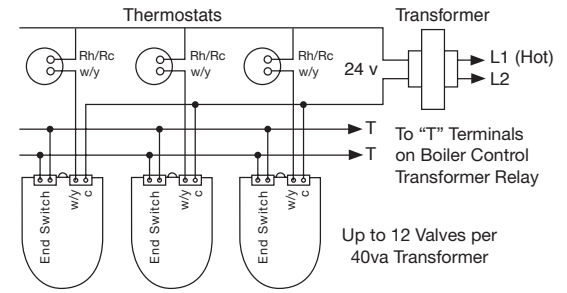

**Wiring a Taco EBV Zone Valve to Replace a Honeywell, Erie or Sparco Valve:**

**Honeywell, Erie and Sparco Wire Leads**

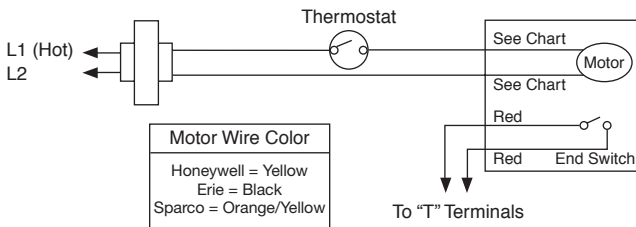

**Honeywell and Erie Terminal Block**

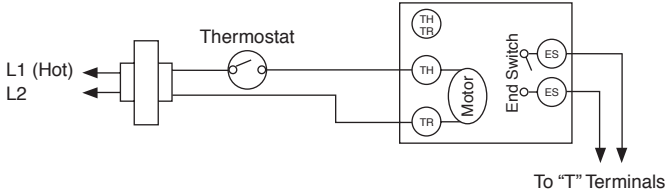

**Taco EBV Valve**

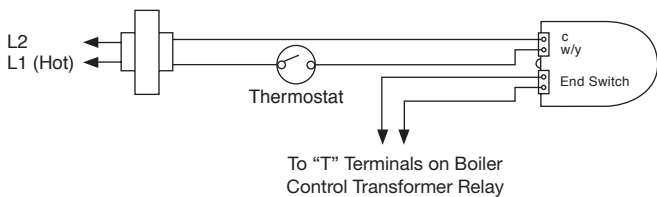

**Wiring a Taco EBV Zone Valve to Replace a Flair or Taco 3-Wire Valve:**

**Flair**

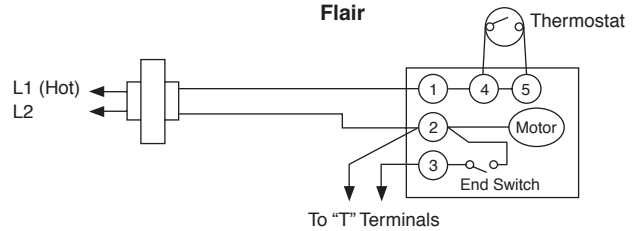

**Taco 570 Series**

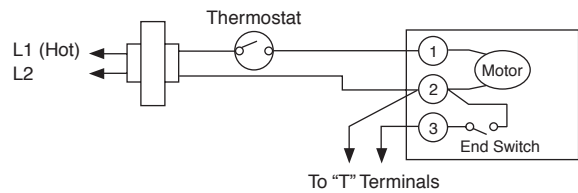

**Taco EBV Valve**

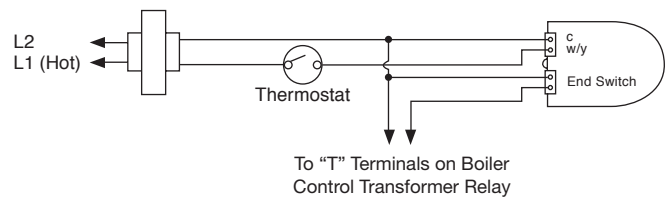

**Wiring a Taco EBV Zone Valve to Replace a White Rodgers Valve:**

**White-Rodgers (1311 or 1321)**

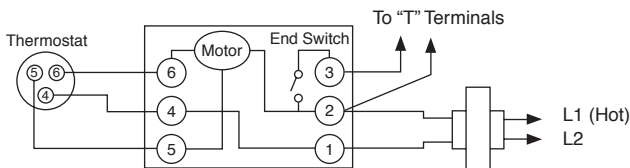

**Taco EBV Valve**

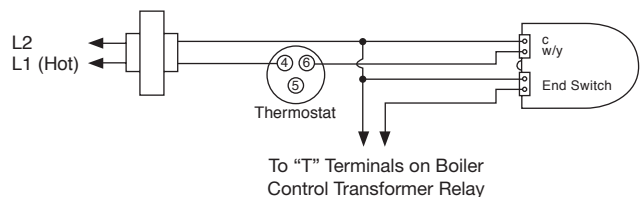

**DO IT ONCE. DO IT RIGHT.™**

TACO, INC., 1160 Cranston Street, Cranston, RI 02920 Telephone: (401) 942-8000 FAX: (401) 942-2360.  
TACO (Canada), Ltd., 6180 Ordan Drive, Mississauga, Ontario L5T 2B3. Telephone: 905/564-9422. FAX: 905/564-9436.

Visit our web site at: <http://www.taco-hvac.com>

Printed in USA

Copyright 2006

TACO, Inc.