



# prestige

## Solo 110

### Water Boiler



## \* INSTALLATION AND MAINTENANCE \* M A N U A L

### NOTICE

Warranty Registration Card must be filled out by the customer and mailed within thirty (30) days of installation in order to gain warranty coverage.

When receiving the PRESTIGE Solo unit, any claims for damage or shortage in shipment must be filed immediately against the transportation company by the consignee.

Leave all documentation received with appliance with owner for future reference.

### WARNING

**If the information in this manual is not followed exactly, a fire or explosion may result causing property damage, personal injury or death.**

#### **FOR YOUR SAFETY**

- Do not store or use gasoline or other flammable vapors and liquids in the vicinity of this or any other appliance.
- **WHAT TO DO IF YOU SMELL GAS**
  - Do not try to light any appliance
  - Do not touch any electrical switch; do not use any phone in your building.
  - Immediately call your gas supplier from a neighbor's phone. Follow the gas supplier's instructions.
  - If you cannot reach your gas supplier, call the fire department.

Installation and service must be performed by a qualified installer, service agency or the gas supplier.

---

**Table of Contents**

---

**PRODUCT AND SAFETY INFORMATION**

---

Definitions . . . . . 1  
Product and Safety Information . . . . . 2

**SECTION I - PRE-INSTALLATION ITEMS**

---

Code Compliance . . . . . 3  
Determining Product Location . . . . . 3  
Boiler Replacement . . . . . 3  
Recommended Clearances . . . . . 4  
Residential Garage Installations . . . . . 4  
Boiler Freeze Protection Feature . . . . . 4

**SECTION II - COMBUSTION AIR AND VENTING**

---

Combustion Air Contamination . . . . . 5  
Ventilation and Combustion Air Requirements - Direct Vent . . . . . 6  
Ventilation and Combustion Air Requirements - Category IV . . . . . 6  
Methods of Accessing Combustion Air into a Space - Category IV . . . . . 7  
    - Indoor Combustion Air . . . . . 7  
    - Outdoor Combustion Air . . . . . 7-8  
    - Combination of Indoor and Outdoor Combustion Air . . . . . 9  
Combustion Air and Vent Piping . . . . . 9  
Removal of an Existing Boiler from a Common Vent System . . . . . 10  
Commonwealth of Massachusetts Installation . . . . . 11

**SECTION III - UNIT PREPARATIONS**

---

Handling Instructions . . . . . 12  
Wall Mounting Installation . . . . . 12  
Wall Mounting Guidelines . . . . . 12  
Wall Bracket Installation - Stud Walls . . . . . 13  
Wall Bracket Installation - Solid Walls . . . . . 13  
Boiler Mounting . . . . . 13

**SECTION IV - BOILER PIPING**

---

General Piping Requirements . . . . . 14  
Pressure Relief Valve . . . . . 14  
Low Water Cut Off Device . . . . . 14  
Boiler Air Vent . . . . . 15  
Additional Limit Control . . . . . 16

---

**Table of Contents**

---

Backflow Preventer . . . . . 16  
Boiler System Piping Applications . . . . . 16  
Expansion Tank and Makeup Water . . . . . 16-17  
    Diaphragm Expansion Tank . . . . . 17  
    Closed-Type Expansion Tank . . . . . 17  
Circulator . . . . . 17  
Sizing Primary Piping . . . . . 17  
Domestic Hot Water System Piping . . . . . 17  
System Piping - Zone Circulators . . . . . 17  
System Piping - Zone Valves . . . . . 17  
Piping Component Legend . . . . . 18  
Near Boiler Piping Diagrams . . . . . 19  
System Piping - Through Boiler . . . . . 20  
System Piping - Radiant Heating . . . . . 20  
System Piping - Special Applications . . . . . 20  
System Piping - Multiple Units Installation . . . . . 20  
System Piping Diagrams . . . . . 21-23

**SECTION V - INSTALLING VENT / COMBUSTION AIR & CONDENSATE DRAIN**

---

Installing Vent and Combustion Air . . . . . 24  
Installing Condensate Drain Assembly . . . . . 24-25

**SECTION VI - GAS PIPING**

---

Gas Supply Piping Connection . . . . . 26  
Natural Gas  
    Pipe Sizing -Natural Gas . . . . . 27  
    Natural Gas Supply Pressure Requirements . . . . . 27  
Propane Gas  
    Pipe Sizing - Propane Gas . . . . . 28  
    Propane Gas Supply Pressure Requirements . . . . . 28  
    Gas Valve/Venturi Assembly . . . . . 29

**SECTION VII - INTERNAL WIRING**

---

General Requirements . . . . . 30  
Fuse Locations . . . . . 30  
Internal Factory Wiring Diagram . . . . . 31

**SECTION VIII - EXTERNAL WIRING**

---

Installation Compliance . . . . . 32  
Line Voltage Connections . . . . . 32

---

# Table of Contents

---

- Circulator Wiring ..... 32-33
- Alarm Wiring ..... 33
- Low Voltage Connections..... 33
- Thermostat Wiring ..... 33-34
- Outdoor Sensor Wiring..... 34
- Domestic Hot Water Wiring ..... 34
- Additional Boiler Limits..... 34
- External Modulation Control ..... 34
- System Sensor Wiring..... 35
- Cascade Wiring..... 35
- Modbus Wiring ..... 35
- Zone Valve Wiring ..... 36
- Zone Circulator Wiring..... 37
- System Piping Wiring Diagrams ..... 38-39

---

## SECTION IX - TRIMAX OPERATION

---

- TriMax User Interface ..... 40
- TriMax Navigation ..... 41
- Trimax Menu Structure..... 42
- Home Screen..... 43
- Status Line Messages ..... 44
- Main Menu ..... 45
- EZ Setup Menu ..... 46
- Heating EZ Setup ..... 46-47
- Domestic Hot Water EZ Setup ..... 48-49
- EZ Setup Reset ..... 49
- Display EZ Setup ..... 49
- CH/DHW Operation ..... 50
- Boiler Information ..... 50
- Information Items ..... 51
- Lockout History ..... 52
- Lockout Screen..... 53
- Manual Reset Hard Lockouts ..... 54
- Automatic Reset Soft Lockouts ..... 55

---

## SECTION X - START-UP PREPARATION

---

- Check Boiler System Fluid Chemistry
  - Boiler Fluid pH Level 6.0 to 8.0 ..... 56
  - Boiler Fluid Hardness Less Than 7 Grains ..... 56
  - Chlorinated Water..... 56
- Flush Boiler System to Remove Sediment..... 56

---

## Table of Contents

---

Cleaning of Old Boiler/System. . . . .	56
Cleaning of New Boiler/System. . . . .	56
Check and Test Antifreeze . . . . .	57
Use of Antifreeze in the Boiler System . . . . .	57
Filling the Boiler System . . . . .	57
Check Low Water Cut-Off Device . . . . .	58
Check for Gas Leaks. . . . .	58
Check Thermostat Circuit. . . . .	58
Inspection of Condensate Drain Assembly. . . . .	58

---

## SECTION XI- START-UP PROCEDURES

---

Final Checks Before Start-Up. . . . .	59
PRESTIGE Solo Start-Up. . . . .	59
If PRESTIGE Solo does Not Start Correctly . . . . .	59
Check the PRESTIGE Solo and System . . . . .	59-62
Operating Instructions. . . . .	63

---

## SECTION XII - OUTDOOR RESET CONTROL

---

Mounting the Outdoor Sensor . . . . .	64
Wiring the Sensor . . . . .	64

---

## SECTION XIII - EXTERNAL MODULATING CONTROL

---

Wiring the Modulating Controller . . . . .	65
TriMax Adjustment. . . . .	65
Programming of External Modulating Control . . . . .	65
Factory TriMax Settings. . . . .	66

---

## SECTION XIV - CHECK-OUT PROCEDURES

---

Check-Out Procedures . . . . .	67
--------------------------------	----

---

## SECTION XV - INSTALLATION RECORD

---

Installation Record . . . . .	68
-------------------------------	----

---

## SECTIONS XVI - MAINTENANCE SCHEDULE

---

Service Technician - General . . . . .	69
Owner Maintenance . . . . .	69

---

## Table of Contents

---

### SECTION XVII - MAINTENANCE PROCEDURES

---

Maintenance Procedures	
Reported Problems . . . . .	70
Check Surrounding Area . . . . .	70
Inspect Burner Area . . . . .	70
Check System Piping . . . . .	70
Clean Condensate Drain Assembly . . . . .	71
Check Ventilation Air Openings . . . . .	71
Inspect Vent and Combustion Air Piping . . . . .	71
Check Boiler System . . . . .	71
Check Expansion Tank . . . . .	72
Check Boiler Relief Valve . . . . .	72
Inspection of Ignition Electrode . . . . .	72
Check Ignition Wiring and Ground Wiring . . . . .	72
Check Control Wiring . . . . .	73
Check Control Settings . . . . .	73
Perform Start-Up and Checkout Procedure . . . . .	73
Check Burner Flame . . . . .	73
Check Flame Signal . . . . .	74
Check Combustion Levels . . . . .	74
Check Flue Gas Temperature . . . . .	74
Clean Heat Exchanger . . . . .	74
Review with Owner . . . . .	75
Handling Previously Fired Combustion Chamber Insulation . . . . .	75

### REPLACEMENT PARTS

---

Replacement Parts . . . . .	76-80
-----------------------------	-------

### PRODUCT SPECIFICATIONS

---

Specifications . . . . .	81-84
--------------------------	-------

---

## Product & Safety Information

---

### Definitions

The following terms are used throughout this manual to bring attention to the presence of potential hazards or important information concerning the product.

 **DANGER**

Indicates the presence of a hazardous situation which, if ignored, will result in death, serious injury or substantial property damage.

**NOTICE**

Indicates special instructions on installation, operation or maintenance, which are important to equipment but not related to personal injury hazards.

 **WARNING**

Indicates a potentially hazardous situation which, if ignored, can result in death, serious injury or substantial property damage.

**BEST PRACTICE**

Indicates recommendations made by ACV-Triangle Tube for the installers which will help to ensure optimum operation and longevity of the equipment

 **CAUTION**

Indicates a potentially hazardous situation which, if ignored, may result in minor injury or property damage.

**NOTICE**

ACV-Triangle Tube reserves the right to modify the technical specifications and components of its products without prior notice.

## Product & Safety Information

### DANGER

Do not use this appliance if any part has been under water. Immediately call a qualified service technician to inspect the appliance and to replace any part of the control system which has been under water.

### WARNING

#### WHAT TO DO IF YOU SMELL GAS

- Do not try to light any appliance
- Do not touch any electrical switch; do not use any phone in your building.
- Immediately call your gas supplier from a neighbor's phone. Follow the gas supplier's instructions.
- If you cannot reach your gas supplier, call the fire department.

Installation and service must be performed by a qualified installer, service agency or the gas supplier.

### WARNING

Should overheating occur or the gas supply fails to shut off, turn OFF the manual gas control valve external to the appliance.

### WARNING

DO NOT add cold make up water when the boiler is hot. Thermal shock can cause potential cracks in the heat exchanger.

### CAUTION

When servicing the boiler:

- Avoid electrical shock by disconnecting the electrical supply prior to performing maintenance.

### WARNING

#### Qualified Installer:

Prior to installing this product read all instructions included in this manual and all accompanying manuals/documents with this appliance. Perform all installation steps required in these manuals in the proper order given. Failure to adhere to the guidelines within these manuals can result in severe personal injury, death or substantial property damage.

#### Homeowner:

- This product should be maintained / serviced and inspected annually by a qualified service technician.
- This manual is intended for use by a qualified Installer/Service Technician.

### NOTICE

Please reference the unit's model number and the serial number from the rating label, on the control panel when inquiring about service or troubleshooting.

### WARNING

ACV-Triangle Tube accepts no liability for any damage, injury or loss of life resulting from incorrect installation, from alteration of any factory supplied parts or from the use of parts or fittings not specified by ACV-Triangle Tube. If there is a conflict or doubt about the proper installation of the unit or any factory supplied or replacement parts please contact ACV-Triangle Tube Technical Support.

### WARNING

A byproduct of any gas fired appliance (stove, fire place, clothes dryer, water heater, furnace, boiler, etc.) is carbon monoxide. In the absence of any state or local codes requiring the installation of carbon monoxide detector and alarms, AVC-Triangle Tube's recommendation is to follow the requirements of the Commonwealth of Massachusetts, see page 11.



---

## Pre-Installation Items

---

### SECTION I - Pre-Installation Items

#### Code Compliance

This product must be installed in accordance to the following:

- All applicable local, state, national and provincial codes, ordinances, regulations and laws.
- For installations in Massachusetts, code requires the boiler to be installed by a licensed plumber or gas fitter, and if antifreeze is utilized, the installation of a reduced pressure backflow preventer device is required in the boiler's cold water fill or make up water supply line.
- For installation in Massachusetts all direct vented appliances must comply with the guidelines as outlined on page 11.
- The National Fuel Gas Code NFPA54/ANSI Z 223.1 - Latest edition.
- National Electric Code ANSI/NFPA 70.
- For installations in Canada -"Installation Code for Gas Burning Equipment" CGA/B149.1 or B149.2 Canadian Electrical Code Part 1 CSA C22.1.
- Standards for Controls and Safety Devices for Automatically Fired Boilers, ANSI/ASME CSD-1, when required.

#### **NOTICE**

**The PRESTIGE Solo boiler gas manifold and gas controls meet the safe lighting and other performance requirements as specified in ANSI Z21.13 latest edition.**

#### Determining Product Location

#### **NOTICE**

**The PRESTIGE boiler is certified for indoor, conditioned space installations ONLY.**

Before locating the PRESTIGE SOLO check for convenient locations to:

- Heating system piping
- Venting
- Gas supply piping
- Electrical service

Ensure the boiler location allows the combustion air/vent piping to be routed directly through the building and terminate properly outside with a minimum amount of length and bends.

Ensure the area chosen for the installation of the PRESTIGE Solo is free of any combustible materials, gasoline and other flammable liquids.

#### **WARNING**

**Failure to remove or maintain the area free of combustible materials, gasoline and other flammable liquids or vapors can result in severe personal injury, death or substantial property damage.**

Ensure the PRESTIGE Solo and its controls are protected from dripping or spraying water during normal operation or service.

The PRESTIGE Solo should be installed in a location so that any water leaking from the boiler or piping connections or relief valve will not cause damage to the area surrounding the unit or any lower floors in the structure.

#### Boiler Replacement

If the PRESTIGE Solo is replacing an existing boiler, the following items should be checked and corrected prior to installation:

- Boiler piping leaks and corrosion.
- Improper location and sizing of the expansion tank on the boiler heating loop.
- If applicable, level and quality of freeze protection within the boiler system.

---

## Pre-Installation Items

---

### Recommended Clearances

The PRESTIGE Solo is approved for zero clearance to combustibles, excluding vent and boiler piping.

- Boiler Piping - 1/4 inch from combustible materials.
- Reference the appropriate vent supplement for clearance requirements.

#### BEST PRACTICE

To provide serviceability to the unit it is recommended that the following clearances be maintained:

Top boiler jacket - 24 inches [610 mm].

Front - 24 inches [610 mm].

Bottom boiler piping - 24 inches [610 mm].

Rear - 0 inches

Sides - 6 inches [153 mm]

#### WARNING

If the clearances listed above cannot be maintained or the enclosure in which the boiler is installed is less than 85 cubic feet, the space must be ventilated. See page 6 for ventilation requirements.

#### NOTICE

When maintaining zero clearance or less than recommended clearances, some product labeling may become hidden and unreadable.

#### WARNING

When installing the PRESTIGE Solo in a confined space, sufficient air must be provided for proper combustion and venting and to allow, under normal operating conditions, proper air flow around the product to maintain ambient temperatures within safe limits to comply with the National Fuel Gas Code NFPA 54 - latest edition.

### Residential Garage Installations

When installing the PRESTIGE Solo in a residential garage, the following special precautions per NFPA 54/ANSI Z223.1 must be taken:

- Mount the unit a minimum 18 inches [458 mm] above the floor level of the garage. Ensure the burner and ignition devices / controls are no less than 18 inches [458 mm] above the floor level.
- Locate or protect the unit in a manner so it cannot be damaged by a moving vehicle.

### Boiler Freeze Protection Feature

The TriMax boiler management system has a freeze protection feature built in. This feature monitors the boiler temperature and responds as follows when no call for heat is present:

- 46°F [8°C] CH (1) & Auxiliary Boiler Pumps ON
- 42°F [6°C] CH (1), Auxiliary Boiler & System Pumps ON, Burner operates at low fire
- 60°F [15°C] Freeze protection ends. Burner & all pumps OFF after completing CH Post Pump Time.

#### CAUTION

The boiler freeze protection feature is disabled during a hard lockout, however the circulators will operate.

#### CAUTION

The boiler freeze protection feature is designed to protect the boiler. The boiler should be installed in a primary/secondary piping arrangement if it is installed in an unheated space or exposed to water temperatures of 46°F or less. See Section IV for primary/secondary piping examples. See Section X for antifreeze guides.

---

## Combustion Air Venting

---

### SECTION II - Combustion Air and Venting

#### Combustion Air Contamination

 **WARNING**

If the PRESTIGE Solo combustion air inlet is located in any area likely to cause or contain contamination, or if products, which would contaminate the air cannot be removed, the combustion air must be repiped and terminated to another location. Contaminated combustion air will damage the unit and its burner system, resulting in possible severe personal injury, death or substantial property damage.

 **WARNING**

Do not operate a PRESTIGE Solo if its combustion air inlet is located near a laundry room or pool facility. These areas will always contain hazardous contaminants.

Pool and laundry products and common household and hobby products often contain fluorine or chlorine compounds. When these chemicals pass through the burner and vent system, they can form strong acids. These acids can create corrosion of the heat exchanger, burner components and vent system, causing serious damage and presenting a possible threat of flue gas spillage or water leakage into the surrounding area.

Please read the information listed below. If contaminating chemicals are located near the area of the combustion air inlet, the installer should pipe the combustion air inlet to an outside area free of these chemicals per SECTION V of this installation manual.

#### Potential contaminating products

- Spray cans containing chloro/fluorocarbons
- Permanent Wave Solutions
- Chlorinated wax
- Chlorine - based swimming pool chemicals / cleaners
- Calcium Chloride used for thawing ice
- Sodium Chloride used for water softening
- Refrigerant leaks
- Paint or varnish removers
- Hydrochloric acid / muriatic acid
- Cements and glues
- Antistatic fabric softeners used in clothes dryers
- Chlorine-type bleaches, detergents, and cleaning solvents found in household laundry rooms
- Adhesives used to fasten building products and other similar products

#### Areas likely to contain these products

- Dry cleaning / laundry areas and establishments
- Beauty salons
- Metal fabrication shops
- Swimming pools and health spas
- Refrigeration Repair shops
- Photo processing plants
- Auto body shops
- Plastic manufacturing plants
- Furniture refinishing areas and establishments
- New building construction
- Remodeling areas
- Garages with workshops

---

## Combustion Air Venting

---

### Ventilation and Combustion Air Requirements - Direct Vent

A Direct Vent appliance utilizes uncontaminated outdoor air (piped directly to the appliance) for combustion.

For Direct Vent installations, involving only the PRESTIGE Solo, in which the minimum service clearances are maintained as listed on page 4, no ventilation openings are required.

For Direct Vent, zero clearance installations involving only the PRESTIGE Solo, the space / enclosure must provide two openings for ventilation. The openings must be sized to provide 1 square inch of free area per 1,000 BTUH of boiler input. The openings shall be placed 12 inches from the top of the space and 12 inches from the floor of the space.

For installations in which the PRESTIGE Solo shares the space with air movers (exhaust fan, clothes dryers, fireplaces, etc.) and other combustion equipment (gas or oil) the space must be provided with adequate air openings to provide ventilation and combustion air to the equipment. To properly size the ventilation / combustion air openings, the installer must comply with the National Fuel Gas Code NFPA 54, ANSI Z223.1 for installations in the U.S or CSA B149.1 and B149.2 for installations in Canada.

#### WARNING

**The space must be provided with ventilation / combustion air openings properly sized for all make-up air requirements (exhaust fans, clothes dryers, fireplaces, etc.) and the total input of all appliances located in the same space as the PRESTIGE Solo, excluding the input of a Direct Vent PRESTIGE Solo which uses combustion air directly from the outside, thus additional free area for the openings is not required. Failure to provide or properly size the openings could result in severe personal injury, death or substantial property damage.**

### Ventilation and Combustion Air Requirements - Category IV

A Category IV appliance utilizes uncontaminated indoor or outdoor air (surrounding the appliance) for combustion.

#### BEST PRACTICE

**In order to reduce the potential risks associated with indoor contaminants (listed on page 5), flammable vapors and tight housing construction (little or no infiltration air), it is recommended to pipe uncontaminated combustion air directly from the outdoors to the appliance. This practice also promotes higher system efficiency by reducing heated indoor air from being exhausted from the house and replaced by cold infiltration air into the house.**

For installations in which the PRESTIGE Solo shares the space with air movers (exhaust fan, clothes dryers, fireplaces, etc.) and other combustion equipment (gas or oil) the space must be provided with adequate air openings to provide ventilation and combustion air to the equipment. To properly size the ventilation / combustion air openings, the installer must comply with the National Fuel Gas Code NFPA 54, ANSI Z223.1 for installations in the U.S or CSA B149.1 and B149.2 for installations in Canada, as referenced in this section of the manual and titled Methods of Accessing Combustion Air into a Space.

#### WARNING

**The space must be provided with ventilation / combustion air openings properly sized for all make-up air requirements (exhaust fans, clothes dryers, fireplaces, etc.) and the total input of all appliances, including the PRESTIGE Solo when located in the same space. Failure to provide or properly size the openings could result in severe personal injury, death or substantial property damage.**

## Combustion Air Venting

### Methods of Accessing Combustion Air Into A Space - Category IV

#### Indoor Combustion Air

##### **NOTICE**

The methods listed in this section for accessing Indoor Combustion Air assume that the infiltration rate is adequate and not less than .40 ACH. For infiltration rates less than .40 ACH, reference the NFPA 54 National Fuel Gas Code for additional guidance.

#### Opening Size and Location

Openings used to connect indoor spaces shall be sized and located in accordance with the following see Fig. 1:

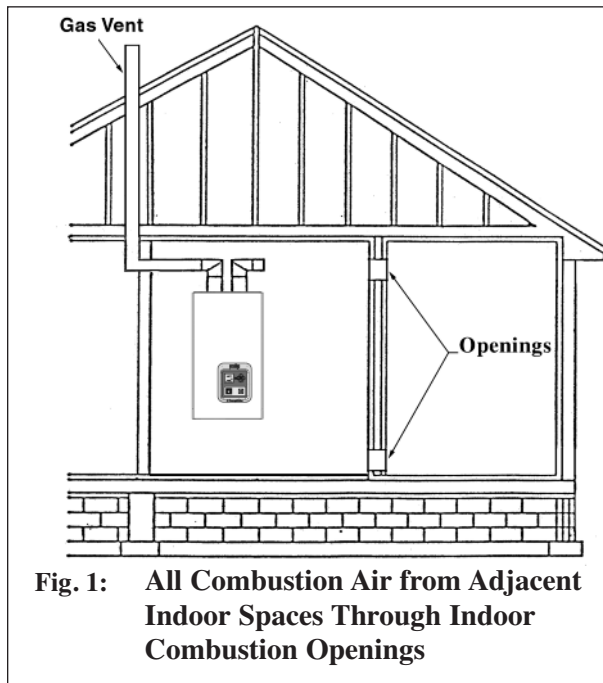

**Fig. 1: All Combustion Air from Adjacent Indoor Spaces Through Indoor Combustion Openings**

- Combining spaces on the same story. Each opening shall have a minimum free area of 1 sq. in./1000 Btu/hr of the total input rating of all gas utilization equipment in the space, but not less than 100 sq. inches. One opening shall commence within 12 inches of the top, and one opening shall commence within 12 inches of the bottom of the enclosure.

The minimum dimension of air openings shall be not less than 3 inches.

- Combining spaces in different stories. The volumes of spaces in different stories shall be considered as communicating spaces where such spaces are connected by one or more openings in doors or floors having a total minimum free area of 2 sq. in./1000 Btu/hr of total input rating of all gas utilization equipment.

#### Outdoor Combustion Air

##### **BEST PRACTICE**

**Isolating the combustion appliance room from the rest of the building and bringing in uncontaminated outside air for combustion and ventilation is always preferred.**

#### Opening Size and Location

The minimum dimension of air openings shall be not less than 3 inches

Openings used to supply combustion and ventilation air shall be sized and located in accordance with the following:

One Permanent Opening Method. See Fig. 2

One permanent opening, commencing within 12 in. of the top of the enclosure, shall be provided. The equipment shall have clearances of at least 1 inch from the sides and 6 in. from the front of the appliance. The opening shall directly communicate with the outdoors or shall communicate through a vertical or horizontal duct to the outdoors or spaces that freely communicate with the outdoors and shall have a minimum free area of the following:

- 1sq. in./3000 Btu/hr of the total input rating of all equipment located in the enclosures, and
- Not less than the sum of the areas of all vent connectors in the space.

## Combustion Air Venting

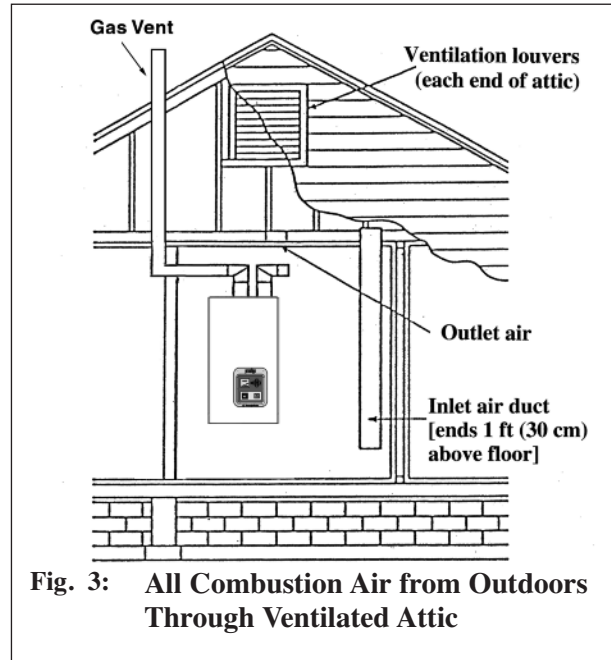
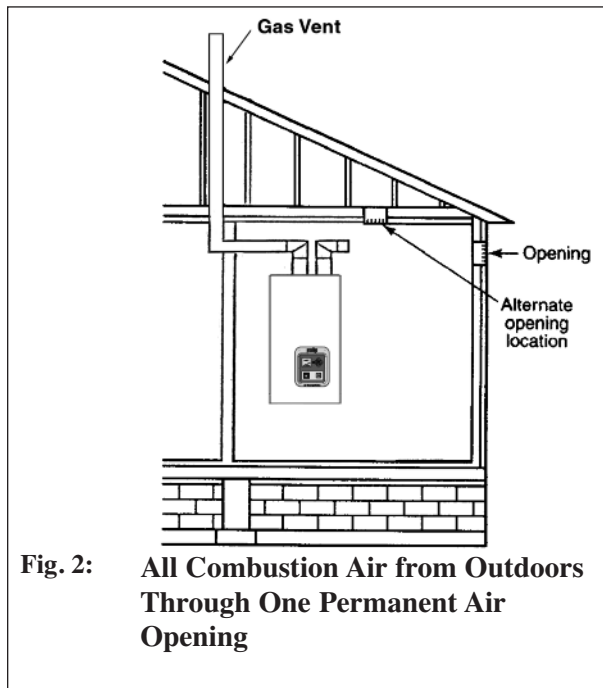

### Two Permanent Openings Method.

Two permanent openings, one commencing within 12 in. of the top and one commencing within 12 in. of the bottom of the enclosure, shall be provided. The openings shall communicate directly, or by ducts, with the outdoors or spaces that freely communicate with the outdoors, as follows:

- Where directly communicating with the outdoors or where communication to the outdoors is through vertical ducts, each opening shall have a minimum free area of 1 sq. in./4000 Btu/hr of total input rating of all equipment in the enclosure. See Fig.3.
- Where communicating with the outdoors is through horizontal ducts, each opening shall have a minimum free area of not less than 1 sq.in./2000 Btu/hr of total input rating of all equipment in the enclosure. See Fig. 4.

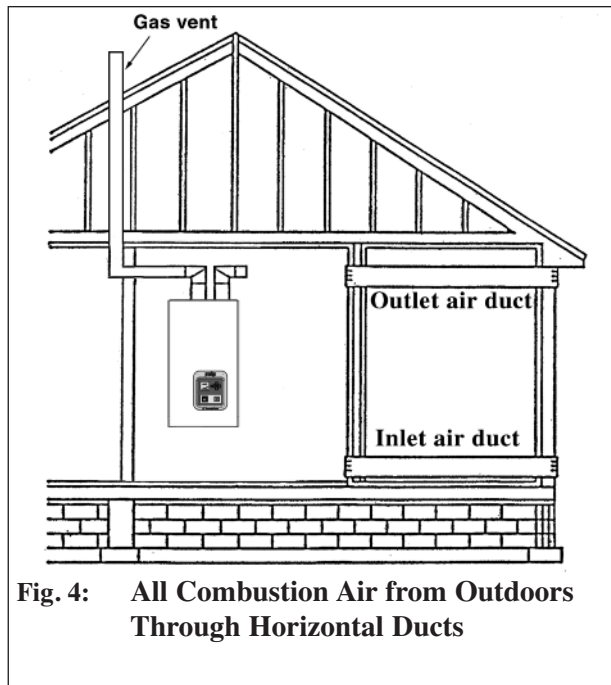

---

## Combustion Air Venting

---

### Combination of Indoor and Outdoor Combustion Air

**Indoor Openings:** Where used, openings connecting the interior spaces shall comply with the Indoor Combustion Air section on page 7.

**Outdoor Opening(s) Location.** Outdoor opening(s) shall be located in accordance with the Outdoor Combustion Air section.

**Outdoor Opening(s) Size.** Outdoor opening(s) shall be calculated in accordance with the following:

- The ratio of the interior spaces shall be the available volume of all communicating spaces divided by the required volume.
- The outdoor size reduction factor shall be 1 minus the ratio of interior spaces.
- The minimum size of outdoor opening(s) calculated in accordance with the above outdoor air section multiplied by the reduction factor. The minimum dimension of air openings shall not be less than 3 in.

 **DANGER**

**Do not install the PRESTIGE Solo into a common vent with other gas or oil appliances. This may cause flue gas spillage or appliance malfunction, resulting in possible severe personal injury, death or substantial property damage.**

### Combustion Air and Vent Piping

The PRESTIGE Solo requires a Category IV venting system, which is designed for pressurized venting and condensate.

The PRESTIGE Solo is certified per ANSI Z21.13 as a Category IV or Direct Vent (sealed combustion) appliance. A Category IV appliance utilizes uncontaminated indoor or outdoor air (surrounding the appliance) for combustion. A Direct Vent appliance utilizes uncontaminated outdoor air (piped directly to the appliance) for combustion.

**BEST PRACTICE**

**In order to reduce the potential risks associated with indoor contaminants (listed on page 5), flammable vapors and tight housing construction (little or no infiltration air), it is recommended to pipe uncontaminated combustion air directly from the outdoors to the appliance. This practice also promotes higher system efficiency by reducing heated indoor air from being exhausted from the house and replaced by cold infiltration air into the house.**

**NOTICE**

**Install combustion air and vent pipe as detailed in the PRESTIGE Solo Vent Supplement included in the boiler installation envelope. Refer to optional vent kit instructions for addition vent installation instructions.**

 **DANGER**

**Verify installed combustion air and vent piping are sealed gas tight and meet all provided instructions and applicable codes, failure to comply will result in severe personal injury or death.**

---

## Combustion Air Venting

---

### Removal of an Existing Boiler from a Common Vent System

#### BEST PRACTICE

**When an existing boiler is removed from a common venting system, the common venting system is likely to be too large for proper venting of the remaining appliances. At the time of removal of an existing boiler, the following steps shall be followed with each appliance remaining connected to the common venting system placed in operation, while the other appliances remaining connected to the common venting system are not in operation.**

1. Seal any unused openings in the common venting system.
2. Visually inspect the venting system for proper size and horizontal pitch and determine there is no blockage or restriction, leakage, corrosion and other deficiencies which could cause an unsafe condition.
3. Insofar as is practical, close all building doors and windows and all doors between the space in which the appliances remaining connected to the common venting system are located and other spaces of the building. Turn on clothes dryers and any appliance not connected to the common venting system. Turn on any exhaust fans, such as range hoods and bathroom exhausts, so they will operate at maximum speed. Do not operate a summer exhaust fan. Close fireplace dampers.
4. Place in operation the appliance being inspected. Follow the lighting instructions. Adjust thermostat so appliance will operate continuously.
5. Test for spillage at the draft hood relief opening after 5 minutes of main burner operation. Use the flame of a match or candle, or smoke from a cigarette, cigar or pipe.
6. After it has been determined that each appliance remaining connected to the common venting system properly vents when tested as outlined above, return doors, windows, exhaust fans, fireplace dampers, and any other gas-burning appliance to their previous condition of use.
7. Any improper operation of the common venting system should be corrected so the installation conforms with the National Fuel Gas Code, ANSI Z223.1/NFPA 54 and/or CAN/CGA B149, Installation codes. When resizing any portion of the common venting system, the common venting system should be resized to approach the minimum size as determined using the appropriate tables in Part II of the National Fuel Gas Code ANSI Z223.1/NFPA 54 and/or CAN/CGA B149, Installation codes.

#### DANGER

**Do not install the PRESTIGE Solo into a common vent with other gas or oil appliances. This may cause flue gas spillage or appliance malfunction, resulting in possible severe personal injury, death or substantial property damage.**



---

## Combustion Air Venting

---

### Commonwealth of Massachusetts Installations Only

For direct-vent appliances, mechanical-vent heating appliances or domestic hot water equipment, where the bottom of the vent terminal and the air intake is installed below four feet above grade the following requirements must be satisfied:

1. If there is not one already present, on each floor level where there are bedroom(s), a carbon monoxide detector and alarm shall be placed in the living area outside the bedroom(s). The carbon monoxide detector shall comply with NFPA 720 (2005 Edition).
2. A carbon monoxide detector shall also be located in the room that houses the appliance or equipment and shall:
  - a. Be powered by the same electrical circuit as the appliance or equipment such that only one service switch services both the appliance and the carbon monoxide detector;
  - b. Have battery back-up power;
  - c. Meet ANSI/UL 2034 Standards and comply with NFPA 720 (2005 Edition); and
  - d. Have been approved and listed by the Nationally Recognized Testing Laboratory as recognized under 527 CMR.
3. A Product-approved vent terminal must be used, and if applicable, a Product-approved air intake must be used. Installation shall be in strict compliance with the manufacturer's instructions. A copy of the installation instructions shall remain with the appliance or equipment at the completion of the installation.

4. A metal or plastic identification plate shall be mounted at the exterior of the building, four feet directly above the location of vent terminal. The plate shall be of sufficient size to be easily read from a distance of eight feet away, and read "**Gas Vent Directly Below**".

<b>NOTICE</b>
---------------

**Installer must provide tag identification plate and ensure the lettering meets code requirements.**

For direct-vent appliances, mechanical-vent heating appliances or domestic hot water equipment, where the bottom of the vent terminal and the air intake are installed above four feet above grade the following requirements must be satisfied:

1. If there is not one already present, on each floor level where there are bedroom(s), a carbon monoxide detector and alarm shall be placed in the living area outside the bedroom(s). The carbon monoxide detector shall comply with NFPA 720 (2005 Edition).
2. A carbon monoxide detector shall:
  - a. Be located in the room that houses the appliances or equipment;
  - b. Be either hard wired or battery powered or both; and
  - c. Shall comply with NFPA 720 (2005 Edition)
3. A Product-approved vent terminal must be used, and if applicable, a Product-approved air intake must be used. Installation shall be in strict compliance with the manufacturer's instructions. A copy of the installation instructions shall remain with the appliance or equipment at the completion of the installation.

---

## Unit Preparations

---

### SECTION III - Unit Preparations

#### Handling Instructions

The PRESTIGE Solo is generally easier to handle and maneuver once removed from the shipping carton.

To remove the shipping carton:



**Use care not to drop, bump or rotate the boiler upside down, as damage to the boiler will result.**

1. Remove any shipping straps and open the side of the shipping carton.
2. Slide the unit with the foam inserts out of the carton.
3. Discard all packing materials.

#### Wall Mounting Installation

The PRESTIGE Solo should be wall mounted using the bracket provided with the boiler. The PRESTIGE Solo is not designed for floor installation. If floor installation is required an optional floor stand is available through ACV-Triangle Tube.

#### **NOTICE**

**The wall used for mounting the PRESTIGE Solo must be vertically plumbed and capable of supporting a minimum 130 pounds [59 kg]. Failure to comply with these requirements could result in personal injury, death or substantial property damage.**

#### Wall Mounting Guidelines

1. The wall-mounting bracket is designed for stud spacing of 12 inch or 16 inch on centers. For unconventional stud spacing, a solid / secure mounting surface must be provided for installation of the bracket.
2. For applications using wood studs, install the bracket using the lag screws provided with the boiler. Ensure both lag screws are installed securely in the studs.
3. For applications using metal studs, install the bracket to the studs using 3/16" toggle bolts and washers.
4. DO NOT mount or attempt to mount the wall bracket to hollow sheet rock or lath walls using anchors. Only install boiler to studs or equivalent wood structure.
5. For applications using solid walls (rock, concrete, brick, cinder block, etc.), install the wall bracket using anchors (double expansion shields) and bolts with washers provided with the boiler.
6. The boiler is too heavy and bulky for a single person to lift and attempt to mount; a minimum of 2 people is required for mounting the boiler.

#### **NOTICE**

**Use extreme care not to drop the boiler or cause bodily injury while lifting or mounting the boiler onto the bracket. Once mounted verify that the boiler is securely attached to the bracket and wall. Failure to comply with the above guidelines could result in property damage, personal injury or death.**

---

## Unit Preparations

---

### Wall Bracket Installation - Stud Walls

1. Locate the studs in the general area of the boiler placement.
2. Place the wall-mounting bracket on the wall centering the mounting slots with the stud centers and ensuring the upper edge of the bracket is away from the wall.
3. Level the bracket, while maintaining it's centering with the studs and use a pencil to mark the location of the mounting slots.
4. Remove the bracket from the wall and drill 1/4" diameter hole by 3" deep positioned in the center of each mark. For applications using metal studs and 3/16" toggle bolts, drill the required clearance hole.
5. Reposition the bracket onto the wall and align mounting slots/holes. Insert the two lag screws provided (or toggle bolts for metal studs) through the mounting slots/holes and loosely tighten.
6. Level bracket and tighten screws (bolts for metal studs) securely making sure not to over-tighten to avoid damaging drywall or plaster.

### Wall Bracket Installation - Solid Walls

1. Locate the general area of the boiler placement.
2. Place the wall-mounting bracket on the wall ensuring the upper edge of the bracket is away from the wall.
3. Level the bracket and use a pencil to mark the location of the mounting slots on the wall.
4. Remove the bracket from the wall and drill a 5/8" diameter hole by 1-3/8" deep positioned in the center of each mark.
5. Install the anchors (provided) flush or slightly recessed in the drilled holes with threaded side facing down.
6. Reposition the bracket on the wall and align mounting slots/holes. Insert the two bolts (provided) through the mounting slots/holes and loosely tighten.
7. Level bracket and tighten bolts securely.

### Boiler Mounting

1. Obtain assistance in lifting the boiler onto the wall bracket.
2. Install the boiler making sure the boiler mounting lip located along the upper edge of the rear jacket panel engages the wall-mounting bracket. Ensure the boiler is seated properly and is secure.

---

## Boiler Piping

---

### SECTION IV - Boiler Piping

#### General Piping Requirements

- All plumbing must meet or exceed all local, state and national plumbing codes.
- Support all piping using hangers. DO NOT support piping by the unit or its components.
- Use isolation valves to isolate system components.
- Install unions for easy removal of the PRESTIGE Solo from the system piping.

#### WARNING

**Use a two wrench method when tightening piping onto the boiler connections. Use one wrench to prevent the boiler piping from turning / twisting. Failure to support the boiler piping and connections in this manner could cause damage to the boiler and its components.**

#### Pressure Relief Valve

1. The PRESTIGE Solo is supplied with a 30 psi pressure relief valve and must be piped using the PRV connection as shown in Fig. 5 page 15.
2. To avoid potential water damage to the surrounding area or potential scalding hazard due to the operation of the relief valve, the discharge piping:
  - Must be connected to the discharge outlet of the relief valve and directed to a safe place of disposal.
  - Length should be as short and direct as possible. The size of the discharge line should not be reduced, maintain the same size as the outlet of the relief valve.
  - Should be directed downward towards the floor at all times. The piping should terminate at least 6 inches [153 mm] above any drain connection to allow clear visibility of the discharge.

- Should terminate with a plain end, not with a threaded end. The material of the piping should have a serviceable temperature rating of 250°F or greater.
- Should not be subject to conditions where freezing could occur.
- Should not contain any shut-off valves or obstructions. No shut-off valve should be piped between the boiler and relief valve.

#### WARNING

**Failure to comply with the guidelines on installing the pressure relief valve and discharge piping can result in personal injury, death or substantial property damage.**

#### Low Water Cutoff Device

- The PRESTIGE Solo is equipped with a factory installed pressure switch type Low Water Cut Off device.
- The minimum operating system pressure allowable with this device is 10 psig.
- Check local codes if a Low Water Cutoff Device is required. If so, determine if this device meets the requirements of the local codes.

#### **NOTICE**

**The PRESTIGE Solo control system also senses the system water temperatures entering and exiting the heat exchanger to provide protection against low water conditions. Where local codes and jurisdiction do not accept a pressure device for low water protection, the jurisdictions may accept these PRESTIGE Solo integral control functions as a means of providing low water protection.**

## Boiler Piping

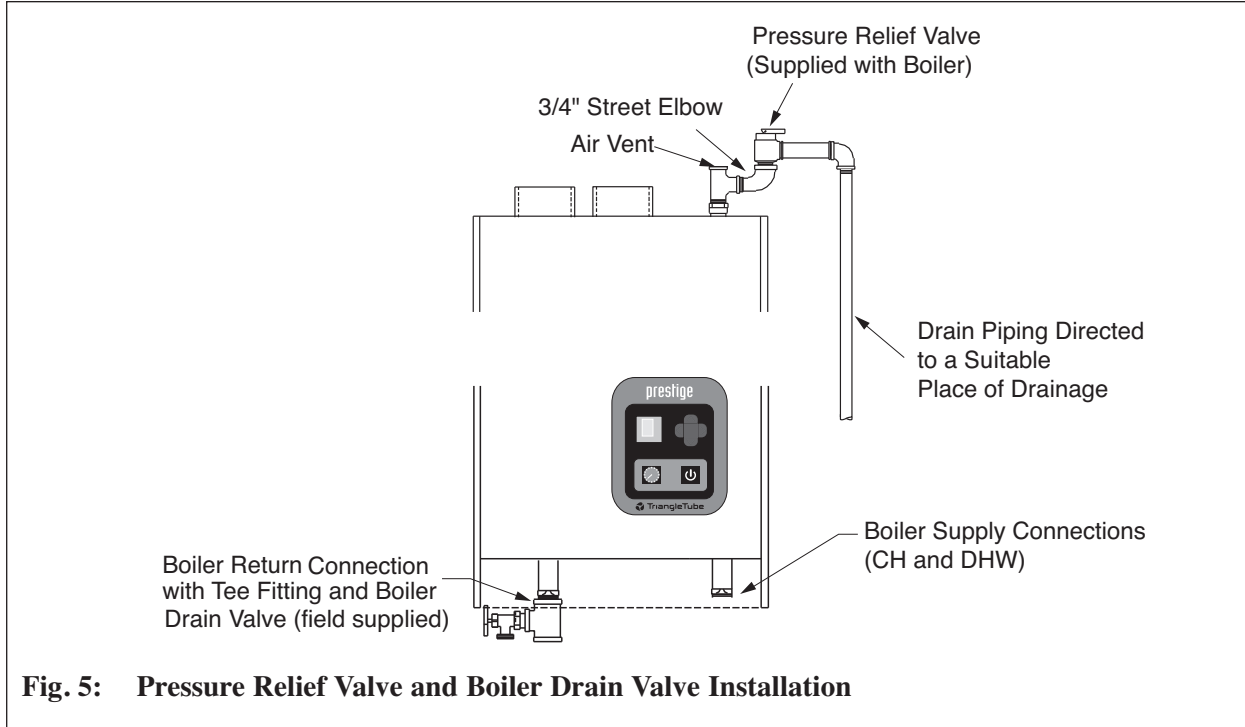

**Fig. 5: Pressure Relief Valve and Boiler Drain Valve Installation**

### Boiler Air Vent

#### **NOTICE**

**This boiler is supplied with a special automatic air vent that will provide reliable operation in purging air from the boiler. The hygroscopic cap supplied with the automatic air vent MUST remain tight at all times on the air vent body. The hygroscopic cap has a membrane which expands upon contact with water and seals the air vent until the membrane dries up due to new air forming in the air vent.**

1. Make sure to fully tighten the cap on the air vent on initial installation.
2. Never loosen the hygroscopic cap to allow air to escape the air vent. Air will exit with the cap fully tightened in place.
3. If the hygroscopic cap is not fully tightened, water may leak from the cap. Simply tighten the cap securely.

---

## Boiler Piping

---

### Additional Limit Control

If a separate LWCO device is required by certain local jurisdictions or when the boiler is installed above the system piping, the following guidelines must be followed:

- The LWCO device must be designed for water installations, electrode probe-type is recommended.
- The LWCO device must be installed in a tee connection on the boiler supply piping above the boiler.
- Wiring of the LWCO device to the PRES-TIGE Solo is done directly onto the low voltage terminal strip, reference Fig. 19 page 31 for available terminals for an external limit (manual or auto reset).

If the installation is to comply with ASME or Canadian requirements, an additional high temperature limit may be needed. Consult local code requirements to determine compliance. The limit should be installed as follows:

- Install the limit in the boiler supply piping between the boiler and any isolation valve.
- Consult heat exchanger for maximum set point of limit.
- For wiring of the limit reference Fig. 19, page 31, using the external limit/manual reset terminals on the low voltage terminal strip. This will provide a "hard" lock-out requiring a manual reset of the control.

### Backflow Preventer

- Use a backflow preventer valve in the make-up water supply to the unit as required by local codes.

### Boiler System Piping Applications

#### BEST PRACTICE

**It is recommended on all piping applications to utilize a primary/secondary piping arrangement as a means to provide freeze protection of the boiler, which is an integral function of the boiler control. Maintain the minimum boiler flow rate, see Graph 2 on page 84. For other piping arrangements, contact ACV-Triangle Tube Technical Support or consult other approved/recognized design arrangements.**

#### BEST PRACTICE

**On piping applications utilizing a single zone or other recognized piping design arrangements, it is recommended that the installer uses flow/check valves with weighted seats at or near the appliance to prevent gravity circulation.**

### Expansion Tank and Makeup Water

Ensure the expansion tank is properly sized for the boiler volume (3 gallons [12 L]) and the system volume and temperature.

#### CAUTION

**Undersized expansion tanks will cause system water to be lost through the pressure relief valve and cause additional makeup water to be added to the system. Eventual boiler heat exchanger failure can result due to this excessive makeup water addition.**

The expansion tank must be located as shown in Fig. 7 and Fig. 8 on page 19 when using a primary/secondary piping arrangement or as per recognized design methods. Refer to the expansion tank manufacturer instructions for additional installation details.

---

## Boiler Piping

---

Connect the expansion tank to an air separator only if the air separator is located on the suction side (inlet) of the system circulator. Always locate and install the system fill connection at the same location as the expansion tank connection to the system.

### Diaphragm Expansion Tank

Always install an automatic air vent on the top of the air separator to remove residual air from the system.

### Closed-Type Expansion Tank

It is recommended to pitch any horizontal piping upwards toward the expansion tank 1 inch per 5 feet of piping. Use 3/4" piping for the expansion tank to allow air within the system to rise.



**DO NOT install automatic air vents on a closed-type expansion tank system. Air must remain in the system and be returned to the expansion tank to provide an air cushion. An automatic air vent would cause air to be vented from the system resulting in a water-logged expansion tank.**

### Circulator

The PRESTIGE Solo is supplied with a Central Heating (CH) circulator that is pre-wired to allow for domestic hot water priority and to provide circulation for the freeze protection feature of the boiler control. See Graph 2 on page 84 for pressure drop and minimum flow rate through the boiler.

### Sizing Primary Piping

See Fig. 9 through 13, pages 21 - 23, for recommended piping arrangements based on various applications. Size the piping and system components required in the space heating system, using recognized design methods.

## Domestic Hot Water System Piping

The PRESTIGE Solo is provided with a separate boiler connection for Domestic Hot Water (DHW) systems (1" NPT.). This connection ensures priority is given to the production and recovery of the DHW.

### NOTICE

**If an indirect fired water heater is not utilized cap the (1" NPT) DHW connection with an adequate amount of pipe dope to ensure a seal.**

See Figs. 9 through 12, page 21-22 for recommended piping to a DHW system.

The piping for the DHW is separate from the boiler system piping and does not require a primary / secondary piping configuration.

To wire the DHW circulator to the boiler control module, reference Section VIII - External Wiring.

### System Piping - Zone Circulators

Connect the PRESTIGE Solo to the system piping as shown in Fig. 9 page 21 when zoning with zone circulators.

The installer must provide a separate circulator for each zone of space heating.

### NOTICE

**To ensure an adequate flow rate through the PRESTIGE Solo, the boiler supply and return piping size must be a minimum of 1 inch.**

### System Piping - Zone Valves

Connect the PRESTIGE Solo to the system piping as shown in Fig. 10 page 21 when zoning with zone valves. The primary / secondary piping ensures that the boiler loop has sufficient flow.

# Boiler Piping

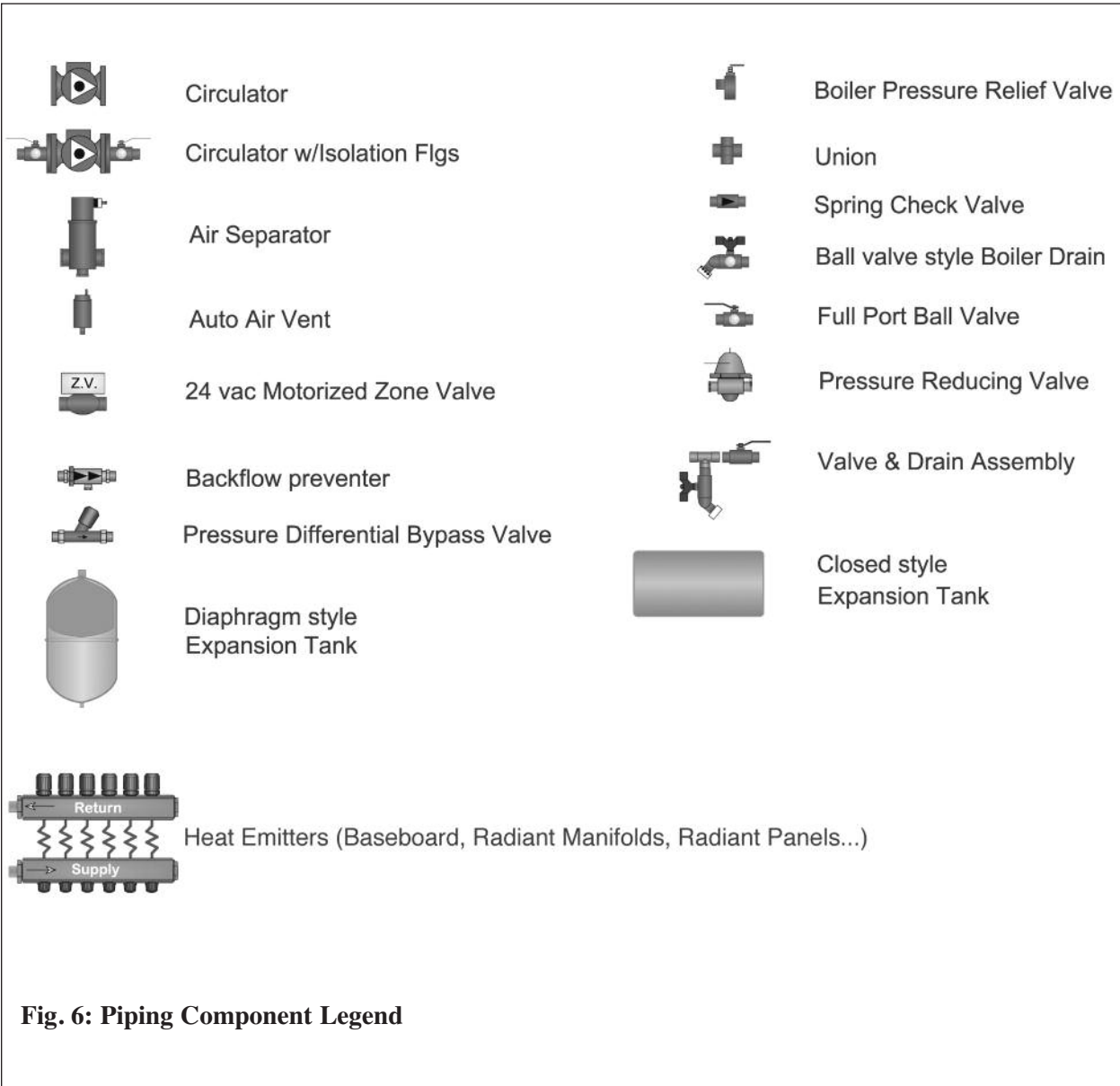

**Fig. 6: Piping Component Legend**



# Boiler Piping

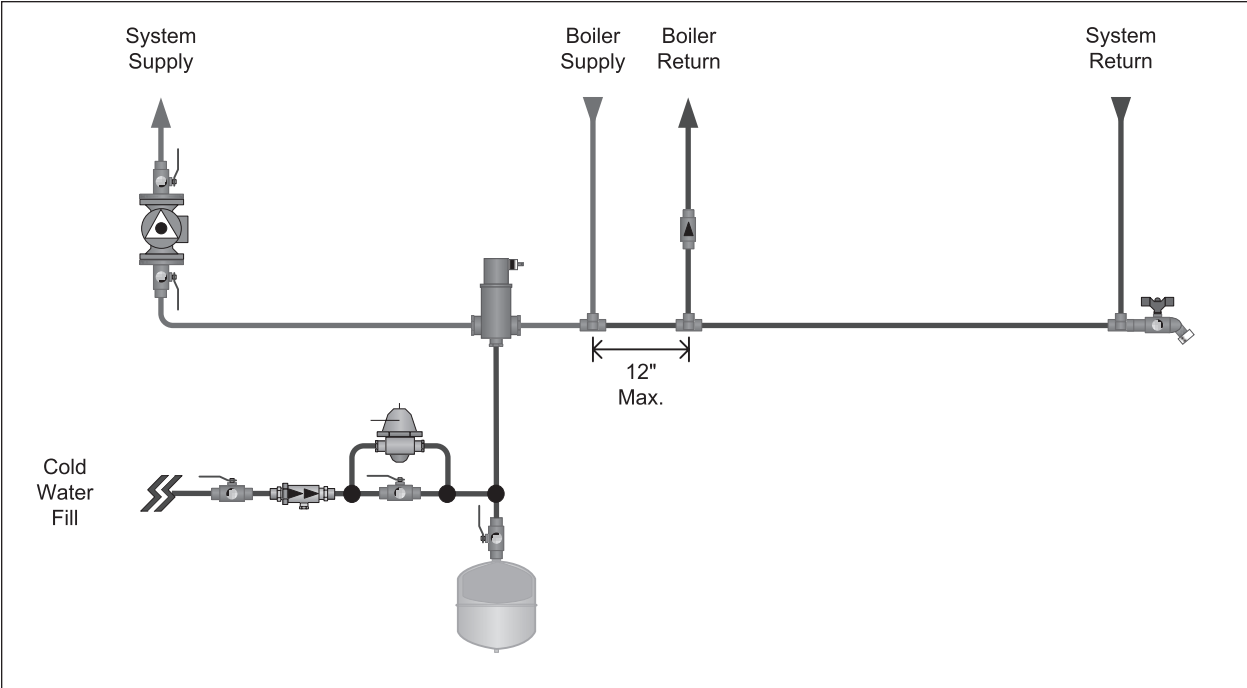

**Fig. 7: Near Boiler Piping - Diaphragm Expansion Tank**

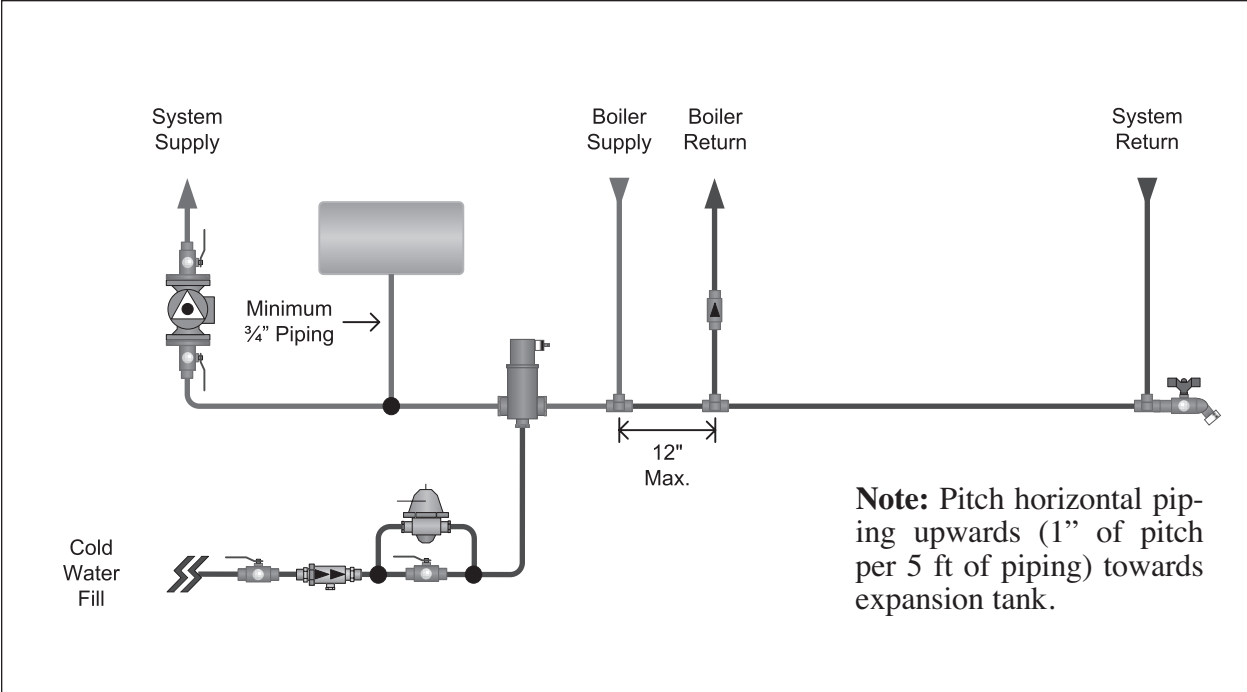

**Fig. 8 : Near Boiler Piping - Closed Type Expansion Tank**

---

## Boiler Piping

---

### NOTICE

To ensure an adequate flow rate through the PRESTIGE Solo, the boiler supply and return piping size must be a minimum of 1 inch.

### System Piping - Through Boiler

In new or retrofit applications in which primary/secondary arrangement is not utilized, the PRESTIGE Solo allows this flexibility due to a lower boiler pressure drop, see Graph 2 on page 84.

Figure 11, page 22 illustrates a multiple zone valve system with a single system/boiler circulator. A by-pass loop with a pressure differential valve must be installed on the system piping.

Figure 12, page 22 illustrates a single zone utilizing the boiler circulator as the system circulator.

### System Piping - Radiant Heating

The heat exchanger design of the PRESTIGE allows operation in a condensing mode. This feature requires no regulation of the return temperature back to the boiler in radiant heating applications.

The design and construction of the PRESTIGE heat exchanger allows the installation of the boiler on systems with non - oxygen barrier tubing.

### CAUTION

**DO NOT install a SMART tank along with the PRESTIGE in systems with non-oxygen barrier tubing. Failure to comply could result in premature failure of the SMART tank.**

The boiler water supply temperature can be maintained by the PRESTIGE, eliminating the need for a mix system to achieve the desired temperature.

It is recommended for the installer to install a high temperature limit to ensure that the primary supply temperature does not exceed the maximum allowable temperature for the radiant tubing.

Size the system piping and circulator to provide the flow needed for the radiant system.

### NOTICE

To ensure an adequate flow rate through the PRESTIGE Solo, the boiler supply and return piping size must be a minimum of 1 inch.

### NOTICE

**The addition of the high temperature limit is important if the PRESTIGE is connected to a domestic hot water system, which requires a high primary supply water temperature.**

### System Piping - Special Application

If the boiler is used in conjunction with a chilled water/medium system, the boiler and chiller must be piped in parallel. Install flow/check valves to prevent the chilled medium from entering into the boiler.

If the boiler is used to supply hot water to the heating coils of an air handler where they may be exposed to chilled air circulation, install flow/check valves or other automatic means to prevent gravity circulation of the boiler water during cooling cycles.

### System Piping - Multiple Units Installation

Use a balanced manifold system as the primary / secondary connection to the space heating piping as shown in Fig. 13 page 23.

Maintain a minimum of 6 inches [153 mm] of clearance between units to allow for servicing.

For the space heating piping refer to the applications mentioned in this manual or use recognized design methods.

## Boiler Piping

**Note:** Reference Fig. 23, page 38 for Prestige Wiring.

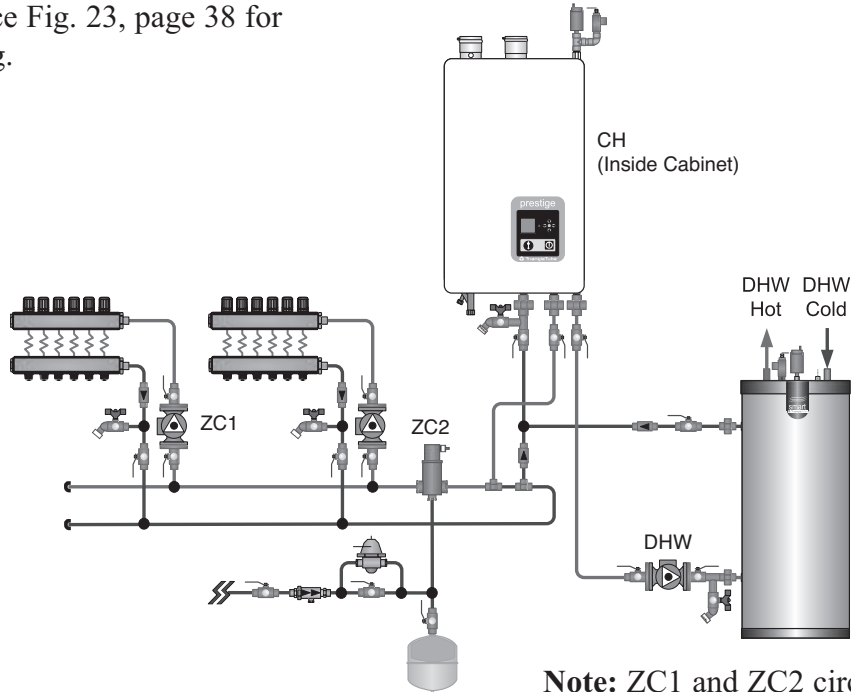

**Note:** ZC1 and ZC2 circulators controlled by SZC5 Zone Panel.

**Fig. 9: System Piping - Zoning with Zone Circulators**

**Note:** Reference Fig. 24, page 38 for Prestige Wiring.

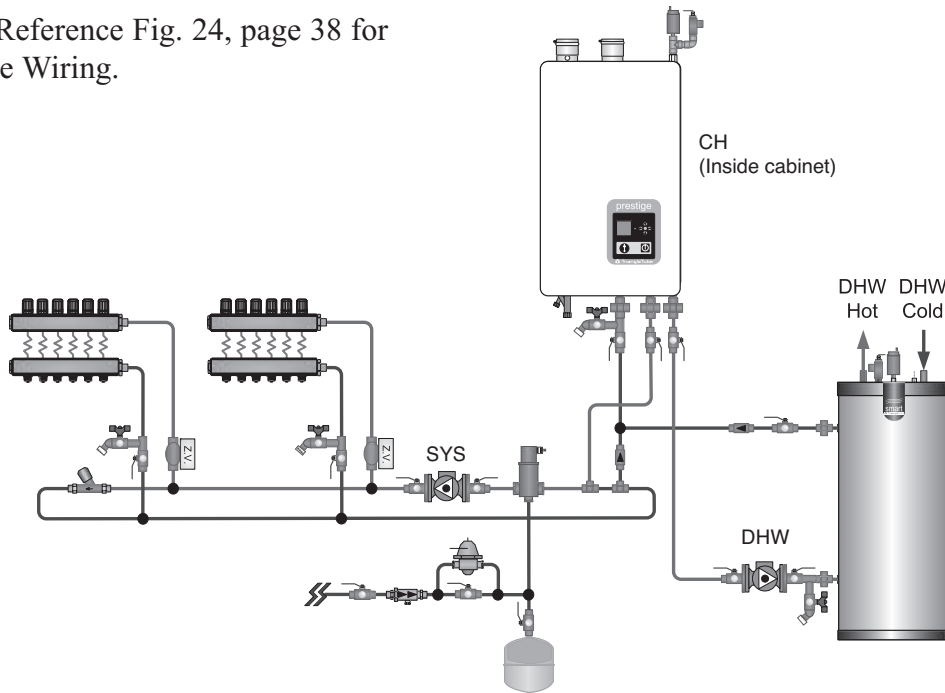

**Fig. 10: System Piping - Zoning with Zone Valves**

### **NOTICE**

The boiler system piping shown must be a “closed” system to avoid any oxygen contamination and potential failure of the outer tank of the Smart.

## Boiler Piping

**Note:** Reference Fig. 25, page 39 for Prestige Wiring.

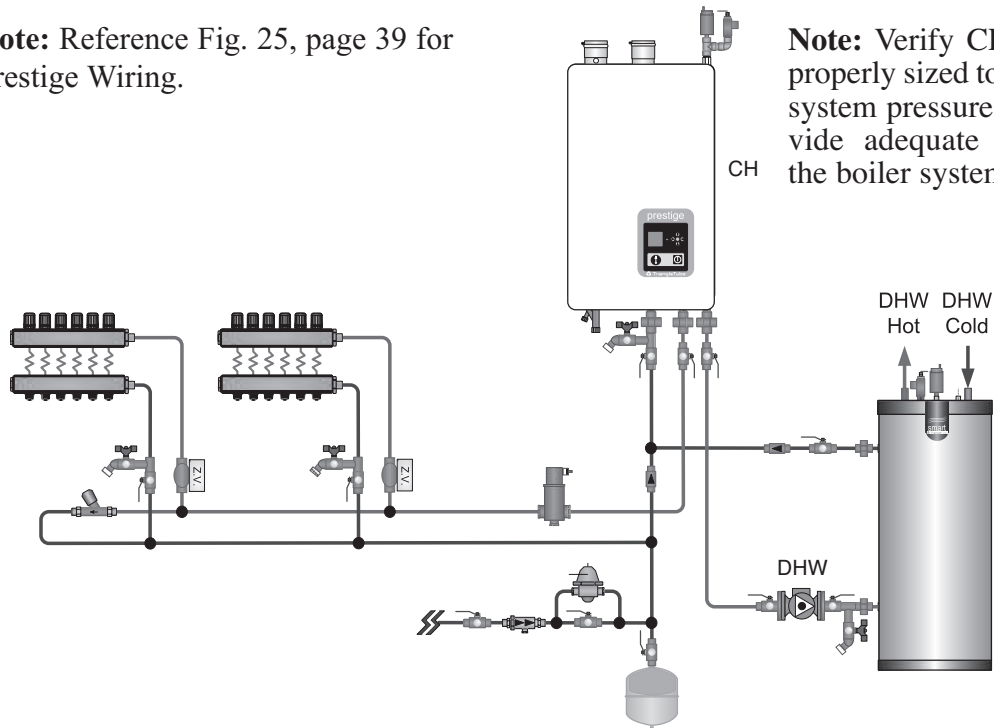

**Note:** Verify CH circulator is properly sized to overcome the system pressure drop and provide adequate flow through the boiler system.

**Fig. 11: System Piping - Multiple Zone Valve with Single System/Boiler Circulator**

**Note:** Reference Fig. 26, page 39 for Prestige Wiring.

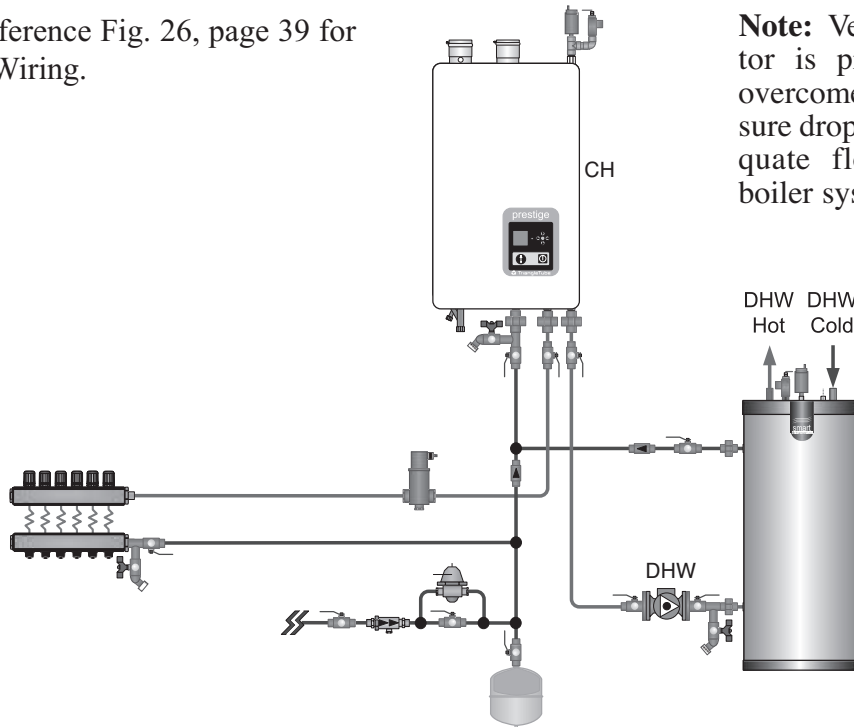

**Note:** Verify CH circulator is properly sized to overcome the system pressure drop and provide adequate flow through the boiler system.

**Fig. 12: System Piping - Single Zone System with Single System/Boiler Circulator**

**NOTICE**

The boiler system piping shown must be a “closed” system to avoid any oxygen contamination and potential failure of the outer tank of the Smart.

# Boiler Piping

**Note:** Consult the PRESTIGE TriMax Control Supplement for information on wiring and configuring the boilers using the built-in Cascade function

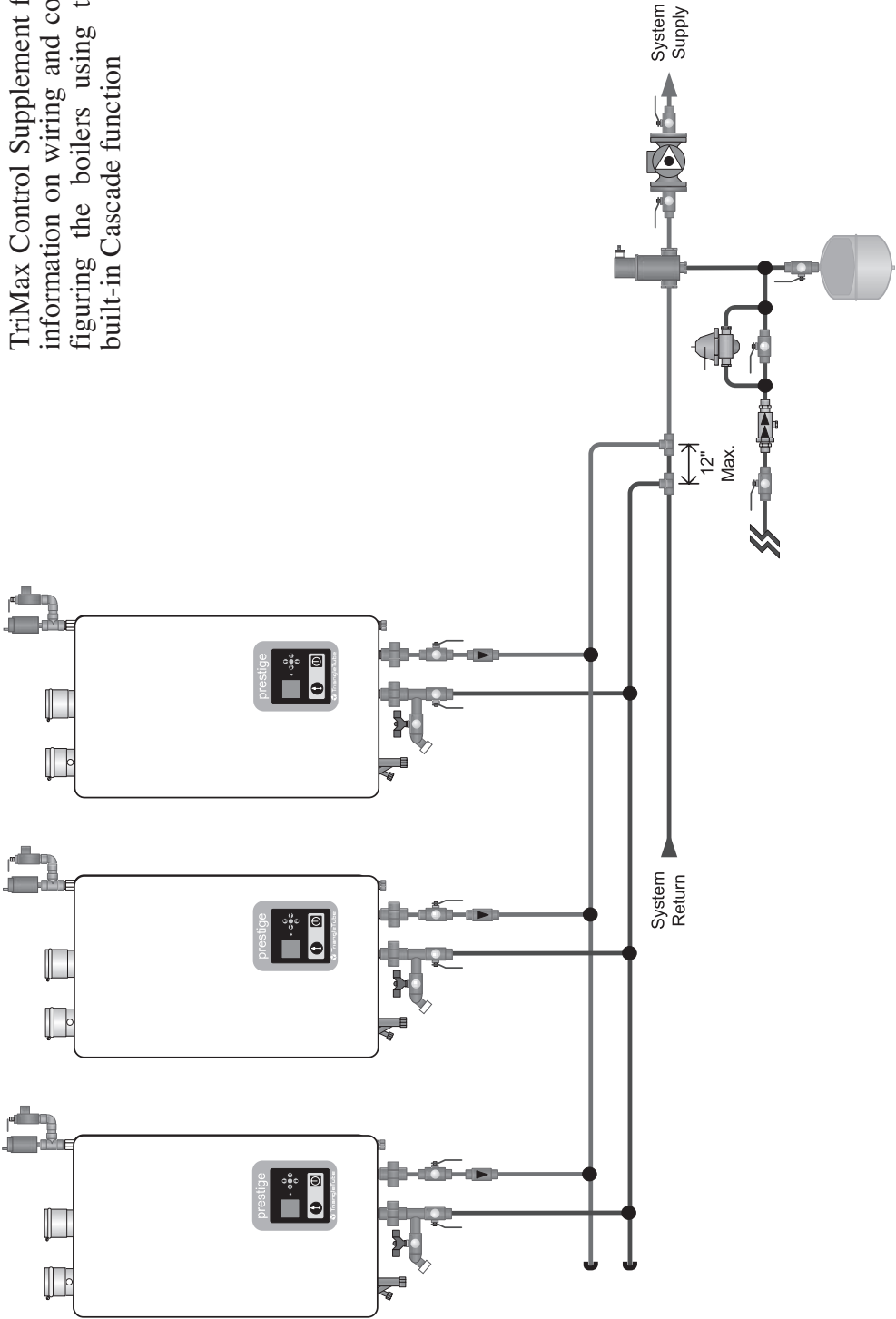

**Fig. 13: Multiple PRESTIGE Solo Boiler Piping - Primary / Secondary**

---

## Installing Vent/Combustion Air & Condensate Drain

---

### SECTION V - Installing Vent / Combustion Air & Condensate Drain

#### Installing Vent and Combustion Air

**⚠ DANGER**

The PRESTIGE Solo must be vented and supplied with combustion air as shown in the PRESTIGE Solo Vent Supplement, included in the boiler installation envelope. Refer to optional vent kit instructions for additional vent installation instructions. Once installation is completed, inspect the vent and combustion air system thoroughly to ensure systems are airtight and comply with the instructions given in the venting supplement and are within all requirements of applicable codes. Failure to comply with the installation requirements on the venting and combustion air piping will cause severe personal injury or death.

#### Installing Condensate Drain Assembly

1. Locate the condensate drain assembly and install as shown in Fig. 14 page 25.
2. Remove the retaining nut, metal washer and rubber seals from the condensate drain assembly. The metal washer must first be cut using a pair of diagonal cutting pliers to make it into a split washer. Insert the metal washer into the retaining nut and screw onto the condensate drain assembly without rubber gaskets. Use the condensate drain assembly as a tool to press the retaining nut with metal washer onto the polypropylene condensate pan.

**NOTICE**

The installer may want to fill the condensate trap with water prior to assembling on the unit.

3. Reassemble the condensate drain assembly onto the boiler by tightening the retaining nut with rubber seal onto the boiler.

**⚠ WARNING**

Ensure installation of the condensate drain assembly included the metal washer. Failure to comply could result in the trap assembly dislocating from the boiler.

**⚠ WARNING**

Ensure the condensate drain assembly contains the plastic seated ball. Do not install the condensate drain assembly if the ball is lost or missing, replace the entire assembly.

4. Remove the compression nut and rubber seal from the drain outlet.
5. Using 3/4" x 2' flexible PVC tube provided, slide the compression nut and rubber seal over the pipe.

**NOTICE**

The use of 3/4" PVC or CPVC pipe is also acceptable. If 3/4" pipe is used deburr and chamfer pipe to allow mating onto the drain assembly.

6. Thread the rubber seal into the compression nut to ease installation of the pipe to the drain assembly.
7. Seat the pipe onto the drain assembly and tighten the compression nut. Hand tight only!

**NOTICE**

The installer may opt to using 13/16" ID tubing in lieu of rigid piping.

## Installing Vent/Combustion Air & Condensate Drain

### NOTICE

The drain line materials must be an approved material by the authority having jurisdiction. In absence of such authority, PVC and CPVC piping must comply with ASTM D1785 or D2845. The cement and primer used on the piping must comply with ASME D2564 or F493. For installations in Canada, use CSA or ULC certified PVC or CPVC pipe, fittings and cement/primer.

8. Continue the pipe from the drain assembly to a floor drain or condensate pump.

### NOTICE

When selecting and installing a condensate pump, ensure the pump is approved for use with condensing boilers and furnaces. The pump should be equipped with an overflow switch to prevent property damage from potential condensate spillage.

9. The PRESTIGE Solo will typically produce a condensate that is considered slightly acidic with a pH content below 3.0. Install a neutralizing filter if required by authority having jurisdiction.

### CAUTION

The condensate drain must remain filled and unobstructed and allow unrestricted flow of condensate. The condensate should not be subject to conditions where freezing could occur. If the condensate is subjected to freezing or becomes obstructed, it can leak, resulting in potential water damage to the boiler and surrounding area.

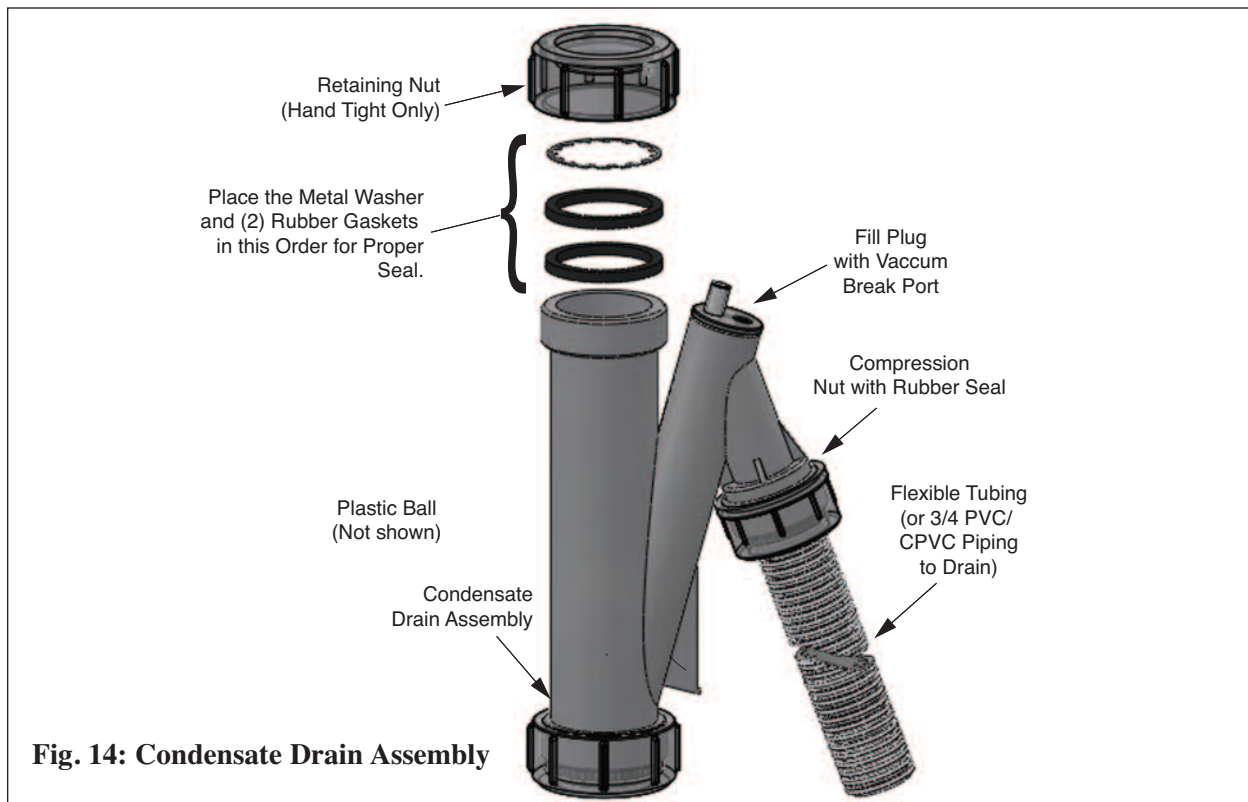

Fig. 14: Condensate Drain Assembly

## Gas Piping

### SECTION VI - Gas Piping

#### Gas Supply Piping Connection

##### NOTICE

The gas supply piping must be installed in accordance to all applicable local, state and national codes and utility requirements.

1. Install a 1/2" NPT pipe union at the factory supplied gas nipple, for ease of service.
2. Install a manual shutoff valve in the gas supply piping as shown in Fig. 15. For installations in Canada the installer must tag and identify the main shutoff valve.
3. Install a sediment trap (drip leg) on the gas supply line prior to connecting to the PRESTIGE Solo gas train as shown in Fig. 15.
4. Support the gas piping using hangers. Do not support the piping by the unit or its components.
5. Purge all air from the gas supply piping.
6. Before placing the PRESTIGE Solo into operation, check and test all connections for leaks.
  - Close the manual shutoff valve during any pressure test with less than 13" w.c..
  - Disconnect the PRESTIGE Solo and its gas valve from the gas supply piping during any pressure test greater than 13" w.c..

##### WARNING

Do not check for gas leaks with an open flame. Use a gas detection device or bubble test. Failure to check for gas leaks can cause severe personal injury, death or substantial property damage.

7. Use pipe dope compatible with natural and propane gases. Apply sparingly only to the male threads of pipe joints so that pipe dope does not block gas flow.

##### WARNING

Failure to apply pipe dope as detailed above can result in severe personal injury, death or substantial property damage.

##### WARNING

Use a two-wrench method of tightening gas piping near the unit and its gas piping connection. Use one wrench to prevent the boiler gas line connection from turning and the second to tighten adjacent piping. Failure to support the boiler gas piping connection could damage the gas line components.

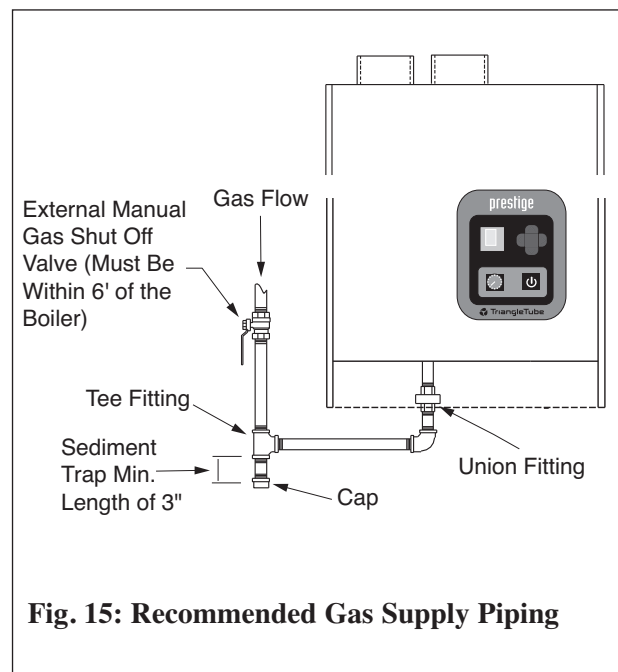

Fig. 15: Recommended Gas Supply Piping



## Gas Piping

### NATURAL GAS

#### Pipe Sizing - Natural Gas

Refer to Table 1 for schedule 40 metallic pipe length and diameter requirements for natural gas, based on rated PRESTIGE Solo input (divide by 1,000 to obtain cubic feet per hour).

- Table 1 is based on Natural Gas with a specific gravity of 0.60 and a pressure drop through the gas piping of 0.30" w.c..
- For additional gas piping sizing information, refer to ANSI Z223.1. For Canadian installations refer to B149.1 or B149.2.

#### Natural Gas Supply Pressure Requirements

1. Pressure required at the gas valve inlet supply pressure port:
  - Maximum 13" w.c. at flow or no flow conditions to the burner.
  - Minimum 5" w.c. during flow conditions to the burner. Must be verified during start up and with all other gas appliances operating within the building.

2. Install 100% lockup gas pressure regulator in the gas supply line if inlet pressure can exceed 13" w.c at any time. Adjust the lock-up pressure regulator for 13" w.c maximum.



**DO NOT adjust or attempt to measure gas valve outlet pressure. The gas valve is factory-set for the correct outlet pressure. This setting is suitable for natural gas and propane and requires no field adjustment. Attempts by the installer to adjust or measure the gas valve outlet pressure could result in damage to the valve, causing potential severe personal injury, death or substantial property damage.**

**Table 1: Gas Piping Sizing - Natural Gas**

Length of Pipe in Feet	Capacity of Schedule 40 Metallic Pipe in Cubic Feet of Natural Gas Per Hour (based on 0.60 specific gravity, 0.30" w.c. pressure drop)				
	SCH 40	1/2"	3/4"	1"	1-1/4"
10	132	278	520	1050	1600
20	92	190	350	730	1100
30	73	152	285	590	890
40	63	130	245	500	760
50	56	115	215	440	670
75	45	93	175	360	545
100	38	79	150	305	460
150	31	64	120	250	380

---

## Gas Piping

---

### PROPANE GAS

#### Pipe Sizing - Propane Gas

 **WARNING**

Prior to start up, ensure the unit is set to fire propane. Check the rating label for the type of fuel. Check the gas valve for propane conversion label. If there is a conflict or doubt on the burner set up, remove the gas valve and check for the propane orifice, see Fig. 16, page 29. Failure to ensure proper burner setup could result in severe personal injury, death or substantial property damage.

Contact the local propane gas supplier for recommended sizing of piping, tanks and 100% lockup gas regulator.

#### Propane Gas Supply Pressure Requirements

1. Adjust the propane supply regulator provided by the gas supplier for 13" w.c. maximum pressure.
2. Pressure required at the gas valve inlet supply pressure port:
  - Maximum 13" w.c. at flow or no flow conditions to the burner
  - Minimum 5" w.c. during flow conditions to the burner. Must be verified during start up and with all other gas appliances operating within the building.

 **WARNING**

**DO NOT** adjust or attempt to measure gas valve outlet pressure. The gas valve is factory-set for the correct outlet pressure. This setting is suitable for natural gas and propane and requires no field adjustment. Attempts by the installer to adjust or measure the gas valve outlet pressure could result in damage to the valve, causing potential severe personal injury, death or substantial property damage.

**NOTICE**

**The propane orifice requirements are:**

**PRESTIGE Solo 110: 0.204" (5.2 mm)**

Gas Piping

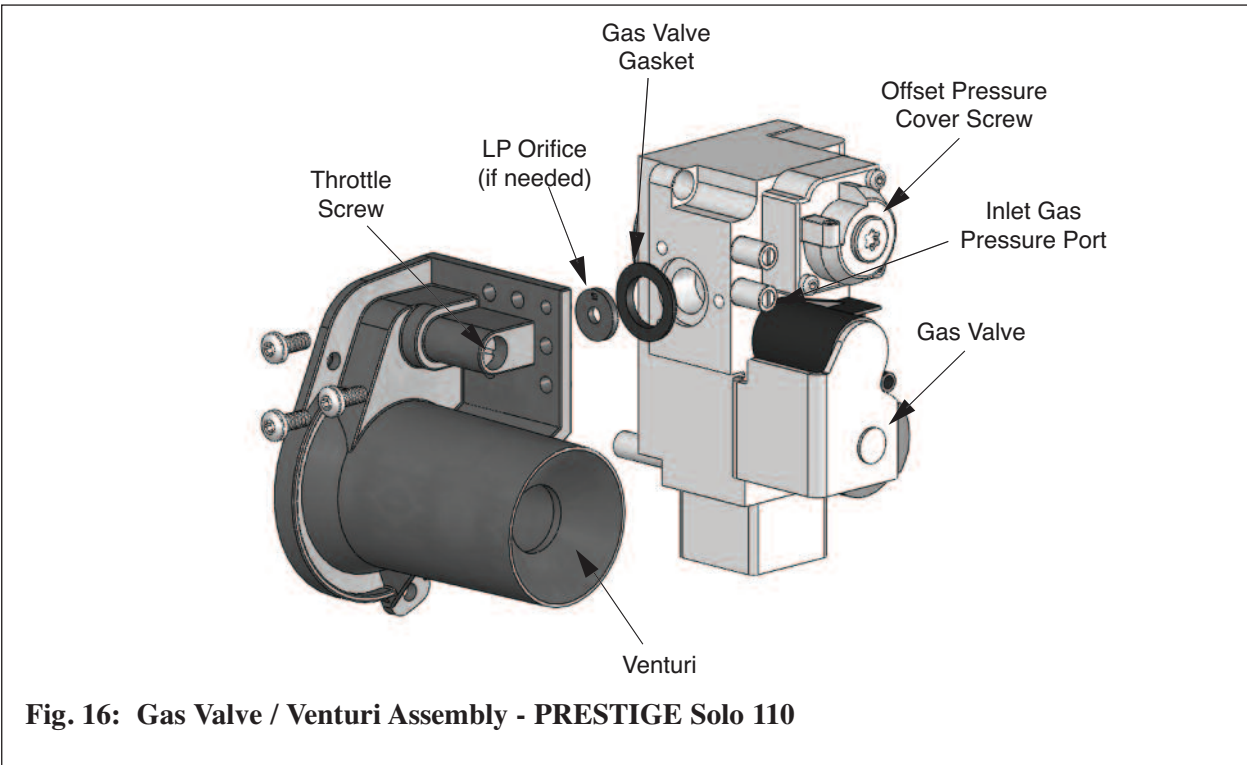

Fig. 16: Gas Valve / Venturi Assembly - PRESTIGE Solo 110

## Internal Wiring

### SECTION VII - Internal Wiring

#### **⚠ WARNING**

**ELECTRICAL SHOCK HAZARD.** For your safety, disconnect electrical power supply to the unit before servicing or making any electrical connections to avoid possible electric shock hazard. Failure to do so can cause severe personal injury or death.

#### **⚠ CAUTION**

Prior to servicing, label all wires before disconnecting. Wiring errors can cause improper and dangerous operation. Verify proper wiring and operation after servicing.

#### General Requirements

- Wiring must be N.E.C Class 1.
- If original wiring as supplied with the unit must be replaced, use only Type T 194°F [90°C] wire or equivalent as a minimum.
- The PRESTIGE must be electrically grounded as required by National Electrical Code ANSI/NFPA 70 - latest edition and / or the Canadian Electrical Code Part 1, CSA C22.1, Electrical Code.

#### Fuse Locations

The TriMax control module contains 2 internal replaceable 5A fuses as shown in Figure 18.

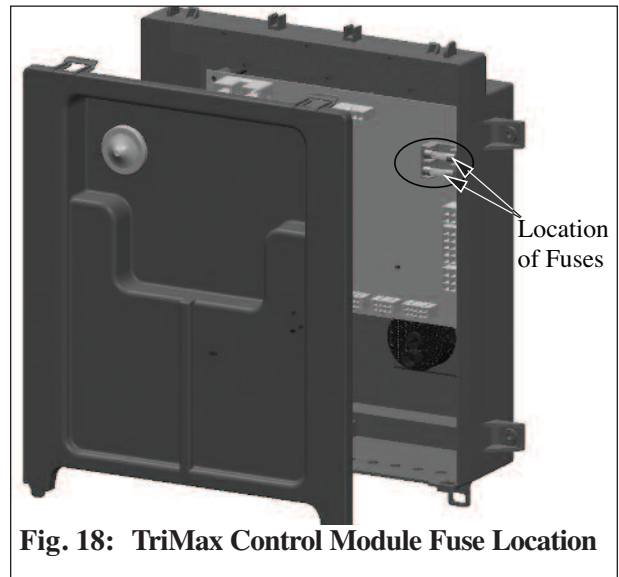
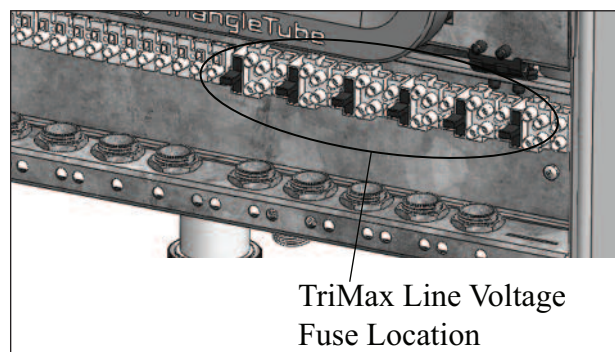

**Fig. 18: TriMax Control Module Fuse Location**

Additional fuses are also located on the line voltage terminals as shown in Fig. 18A and Fig. 19.

#### TriMax Line Voltage Fuses

Fuse Size	Terminals	Purpose
2.5A	23,24,25	CH2 /System Pump
2.5A	26,27,28	Auxiliary Boiler Pump
2.5A	29,30,31	DHW Pump / Diverter Valve
2.5A	32,33,34	CH1 Pump/Diverter Valve
8.0A	35,36,37	Power Supply
2.5A	38,39,40	Alarm



**Fig. 18A: Fuse Location on the line voltage Terminals**

# Internal Wiring

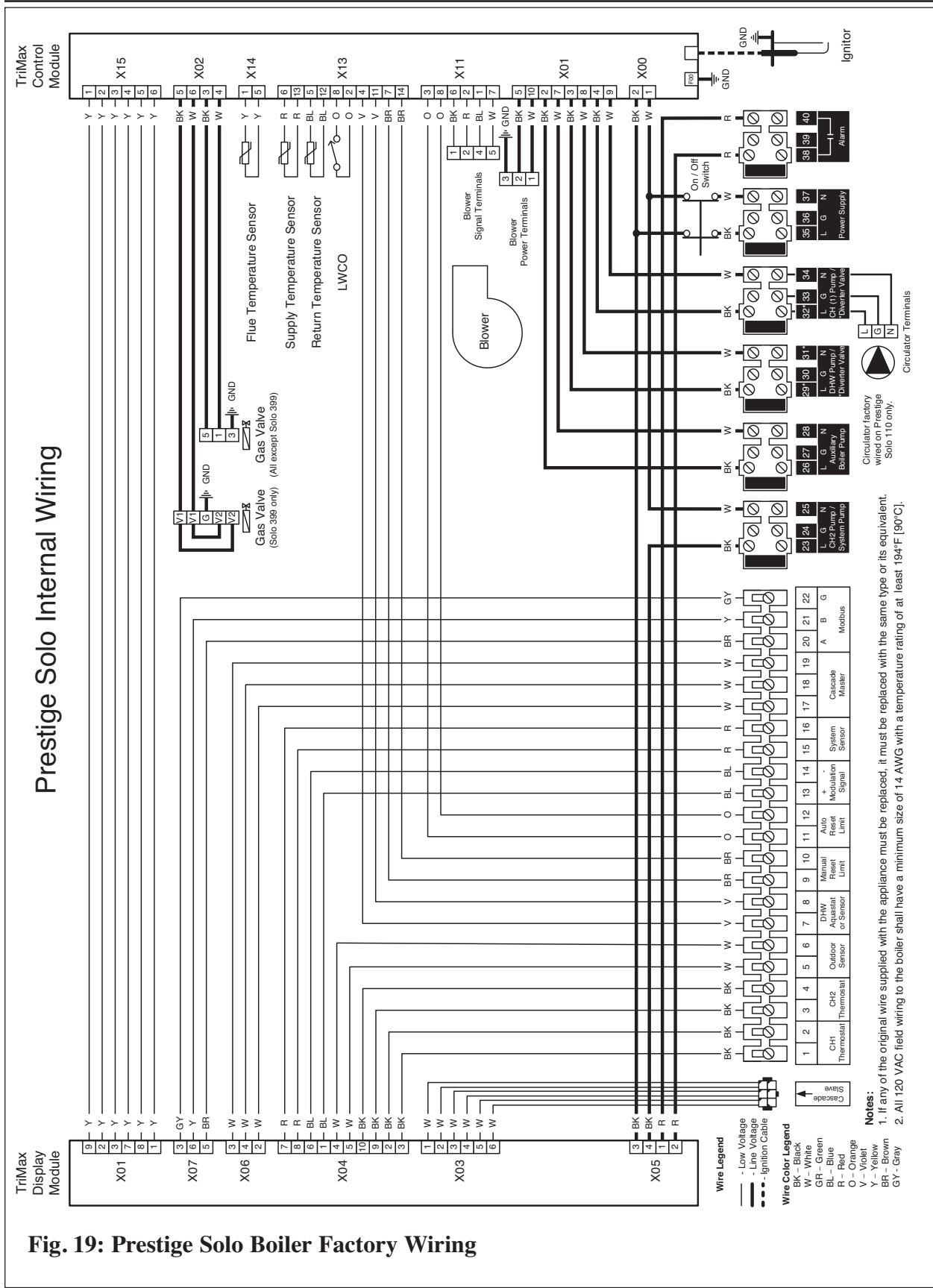

**Fig. 19: Prestige Solo Boiler Factory Wiring**

## External Wiring

### SECTION VIII- External Wiring Installation Compliance

All field wiring made during installation must comply with:

- National Electrical Code NFPA 70 and any other national, state, provincial or local codes or requirements.
- In Canada, CSA C22.1 Canadian Electrical Code Part 1, and any other local codes.

#### **WARNING**

**ELECTRICAL SHOCK HAZARD. Before making any electrical connections to the PRESTIGE, disconnect electrical power supply at the service panel. Failure to comply can cause severe personal injury or death.**

#### **NOTICE**

**The line voltage terminals are located on the right set of terminals 23 through 40. The low voltage terminals are located on the left set of terminals 1 through 22.**

### Line Voltage Connections

1. Connect a dedicated 120 VAC/15A service to the line voltage terminal strip on the wiring panel below the PRESTIGE control module, as shown in Fig. 19, page 31.
2. Route the incoming 120 VAC power wire through the provided openings in the bottom jacket panel.
3. The unit is provided with a service switch located on the front panel, check local code requirements for compliance.

#### **NOTICE**

**If local electrical codes or conditions require an additional service switch, the installer must provide and install a fused disconnect or 15 amp (minimum) service switch.**

### Circulator Wiring

1. Reference Table 2 to determine the appropriate circulator connections required. The circulator connections used will depend on the systems piping layout.

**Table 2: Circulator Operation  
Default Setting**

	CH (1) Pump	DHW Pump	Auxillary Boiler Pump	System Pump
CH 1 or CH 2 Call	ON	OFF (Note 1)	ON	ON
DHW Call	OFF (Note 1)	ON	ON	OFF (Note 2)

Note1: Domestic Hot Water Priority can be disabled in the Installer Menu which allows the CH (1) and DHW circulators to operate at the same time. Consult the PRESTIGE TriMax Control Supplement for more information.

Note2: The system circulator can also be enabled during a DHW Call in the Installer Menu. Consult the PRESTIGE TriMax Control Supplement for more information.

#### **NOTICE**

**Each circulator is individually fused with a 2.5A fuse located in the terminal strip. The total combined amp draw of the CH (1), DHW, and Auxiliary Boiler Circulators must not exceed 4 amps at any time for the Solo 110. Use an isolation relay to lower the total combined amp draw if exceeding these limits.**

2. The CH circulator is prewired to the line voltage terminal strip on the wiring panel below the PRESTIGE control module, as shown in Fig. 19 on page 31. The CH circulator is enabled during a CH 1 or CH 2 call. This circulator is used to supply heat to the central/space heating loop.

---

## External Wiring

---

3. Connect the DHW circulator to the line voltage terminal strip on the wiring panel below the PRESTIGE control module, as shown in Fig. 19 on page 31. The DHW circulator is enabled during a DHW call. This circulator is used to supply heat to an indirect hot water heater.
4. Connect the Auxiliary Boiler circulator to the line voltage terminal strip on the wiring panel below the PRESTIGE control module, as shown in Fig. 19 on page 31. The auxiliary boiler circulator is enabled during a CH or a DHW call. This circulator is typically used in retrofit applications where the CH and DHW systems are connected to a common boiler supply.
5. Connect the System circulator to the line voltage terminal strip on the wiring panel below the PRESTIGE control module, as shown in Fig. 19 on page 31. The system circulator is enabled during a CH1 or CH2 call with the factory default TriMax settings. This circulator is typically used to circulate water in the secondary CH loop when zoning with zone valves.

### Alarm Wiring

The alarm contact closes whenever the Prestige is in a soft or hard lockout. This dry contact can be connected to an external monitoring system or other indicator to alert the operator that the Prestige is locked out.

1. Connect the external monitoring device to the line voltage terminal strip on the wiring panel below the PRESTIGE control module, as shown in Fig. 19 on page 31.

**NOTICE**

**The alarm contact is fused with a 2.5A fuse located in the terminal strip. An isolation relay is required if the external monitoring device draws more than 2.5A.**

### Low Voltage Connections

**NOTICE**

**Line and Low Voltage wiring should be separated to prevent possible electrical noise on the low voltage circuits. Line and Low Voltage wiring should use separate electrical knockouts on the PRESTIGE cabinet and should remain separated inside the PRESTIGE.**

**NOTICE**

**CH and DHW call connections to the PRESTIGE require a dry contact with no external voltage present. Ensure no external voltage is present on each set of wires before connecting to the PRESTIGE. If external voltage is present, the use of an isolation relay is required to prevent damage to the TriMax controller.**

### Thermostat Wiring

The TriMax control has two thermostat call inputs for multiple zone / temperature systems. This allows each call to have its own outdoor reset curve and maximizes the efficiency of the system.

 **WARNING**

**Simultaneous CH1 and CH2 calls will result in the PRESTIGE operating at the highest target temperature. The use of a mixing device on the lower temperature zones such as the ACV-Triangle Tube Optima Series SMV Control may be required to protect the lower temperature zones from damage.**

1. Connect the room thermostat or dry contact end switch to the low voltage terminal strip on the wiring panel below the PRESTIGE control module, as shown in Fig. 19 on page 31.

---

## External Wiring

---

2. Follow thermostat manufacturer's instructions for proper installation. Thermostat should be located on an inside wall away from any heat or cold influences such as drafts, lights, fireplaces, etc.
3. Set the thermostat anticipator (If applicable) as follows:
  - Set for 0.2 amps when wired directly to the PRESTIGE.
  - Set to match the electrical power requirements of the connected device when wired to zone relays or other devices. Refer to the relay manufacturer's specifications and the thermostat instructions for additional information on anticipator setting.

### NOTICE

**The use of power stealing thermostats which draw their power from the PRESTIGE can lead to erratic or unpredictable operation.**

## Outdoor Sensor Wiring

The Outdoor Reset function and Warm Weather Shutdown (WWSD) features require the connection of the included outdoor temperature sensor. See page 64 for outdoor sensor installation and setup.

## Domestic Hot Water Wiring

The Domestic Hot Water terminals can accept either a call from an aquastat (switch) or temperature sensor. Use of the included indirect water heater sensor is recommended.

1. Connect the DHW aquastat or temperature sensor to the low voltage terminal strip on the wiring panel below the PRESTIGE control module, as shown in Fig. 19 on page 31.

## Additional Boiler Limits

Additional boiler limits (High Limit, LWCO, etc.) can be wired into either the Manual Reset Limit or Auto Reset Limit terminals of the PRESTIGE. These limit connections will provide a "hard" lockout requiring a manual reset of the PRESTIGE or a "soft" lockout in which the PRESTIGE will automatically reset when the limit resets.

### NOTICE

**Manual Reset Limit and Auto Reset Limit connections to the PRESTIGE require a dry contact with no external voltage present. Ensure no external voltage is present on each set of wires before connecting to the PRESTIGE. If external voltage is present, the use of an isolation relay is required to prevent damage to the TriMax controller.**

1. Remove the factory installed jumper wire on the Manual Reset or Auto Reset terminals that will accept the additional boiler limit.
2. Connect the additional boiler limit to the low voltage terminal strip on the wiring panel below the PRESTIGE control module, as shown in Fig. 19 on page 31.

## External Modulation Control

The PRESTIGE firing rate can be controlled by an external modulating boiler controller. See page 65 for external modulation signal wiring and setup.



---

## External Wiring

---

### System Sensor Wiring

An optional system temperature sensor can be placed on the central heating loop to control the temperature in the central heating loop instead of the boiler loop. When connected, the PRESTIGE will automatically modulate to maintain the target temperature in the central heating loop. The boiler supply temperature sensor will continue to be used as a high temperature limit.



**Locate the system temperature sensor where it can accurately measure the supply temperature to the heating system. Inaccurate system temperature readings could lead to overheating or under heating resulting in property damage.**

1. Connect the system temperature sensor to the low voltage terminal strip on the wiring panel below the PRESTIGE control module, as shown in Fig. 19 on page 31.

### Cascade Wiring

The TriMax control includes the ability to operate up to six boilers together as one without the need for external controllers. Consult the PRESTIGE TriMax Control Supplement for more information.

### Modbus Wiring

The TriMax control includes the ability to communicate with building management systems (BMS) through a Modbus interface. Consult the PRESTIGE TriMax Control Supplement for more information.

# External Wiring

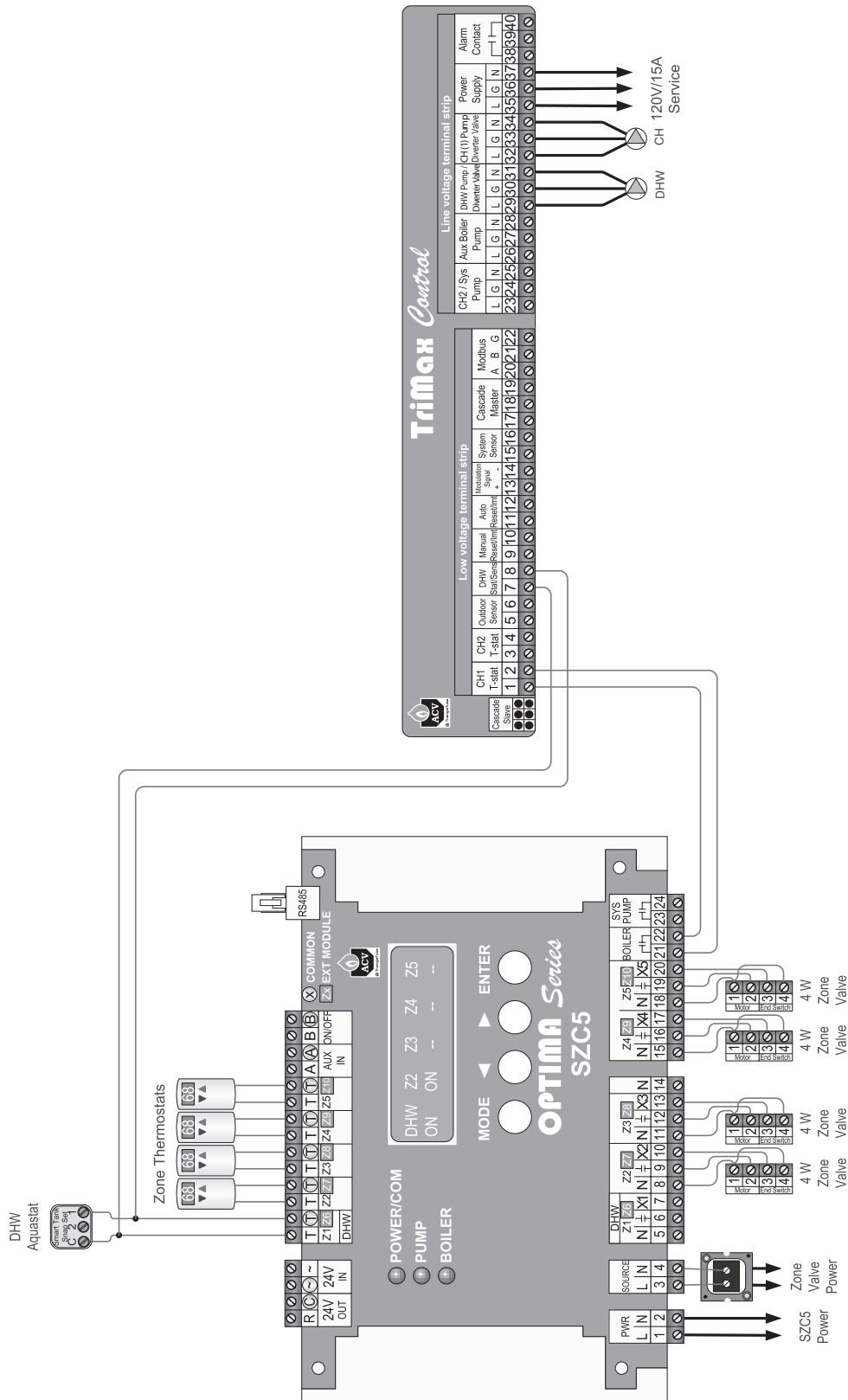

Fig. 20: Multiple Zone Field Wiring Using Zone Valves

# External Wiring

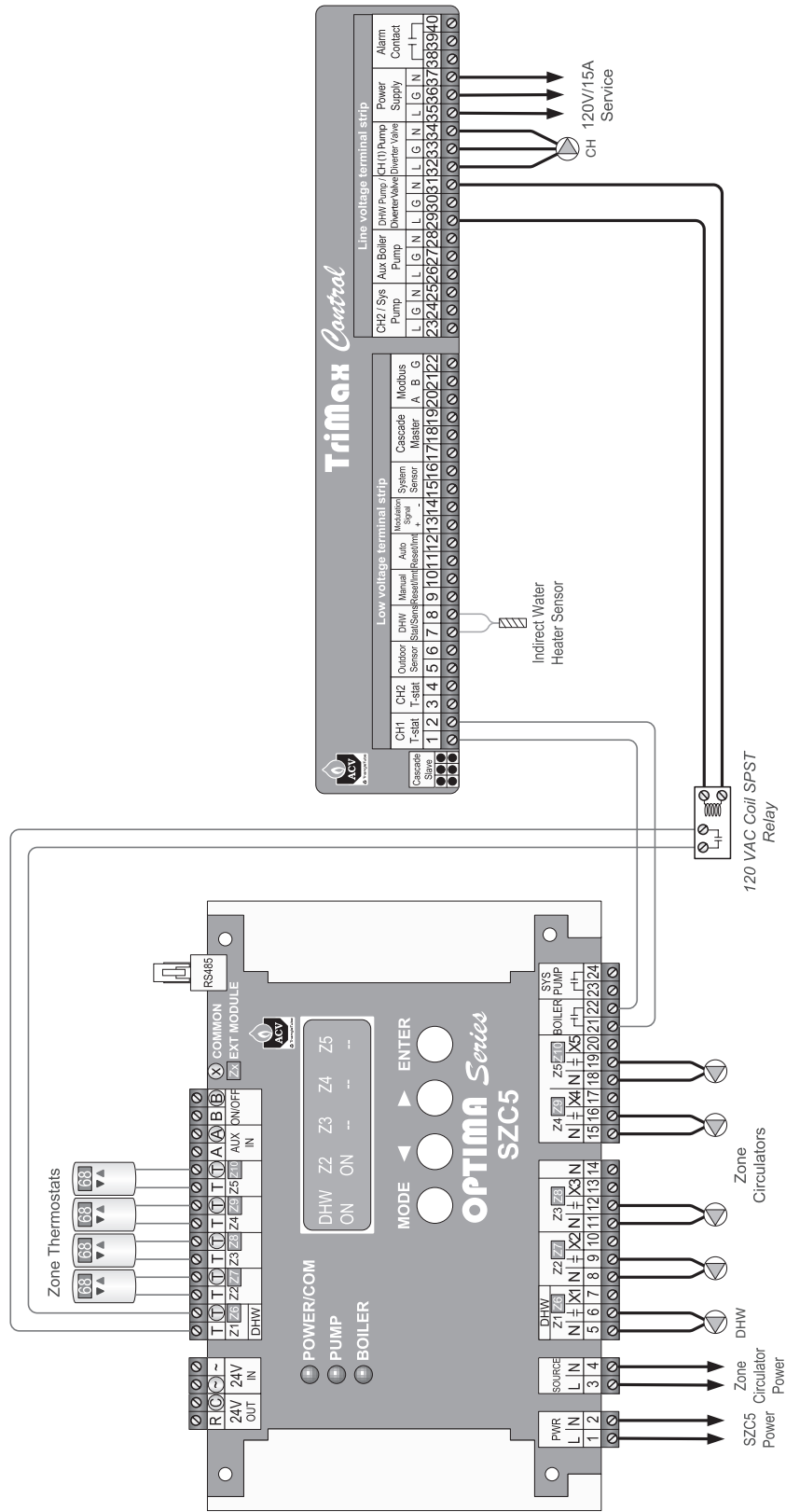
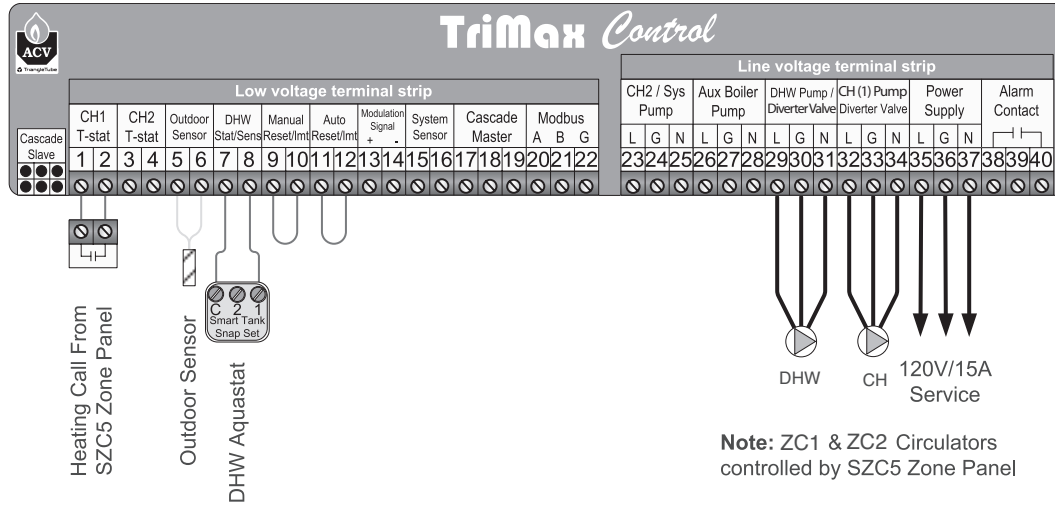

Fig. 21: Multiple Zone Field Wiring using Zone Circulators

## External Wiring

**Note:** Reference Fig. 9, page 21 for System Piping.



**Fig. 23: Prestige Wiring - Zoning with Zone Circulators**

**Note:** Reference Fig. 10, page 21 for System Piping.

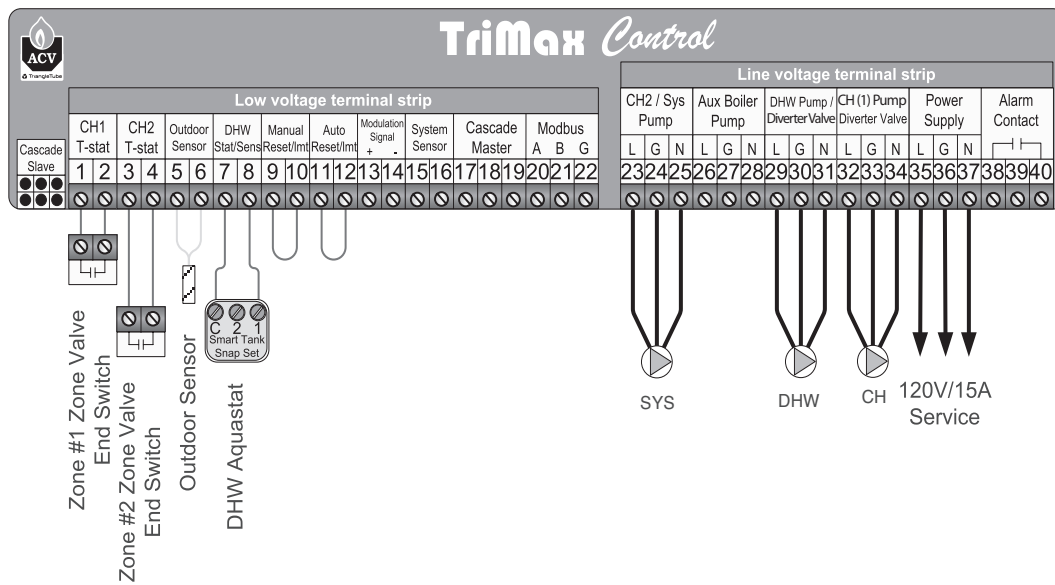

**Fig. 24: Prestige Wiring - Zoning with Zone Valves**

## External Wiring

**Note:** Reference Fig. 11, page 22 for System Piping.

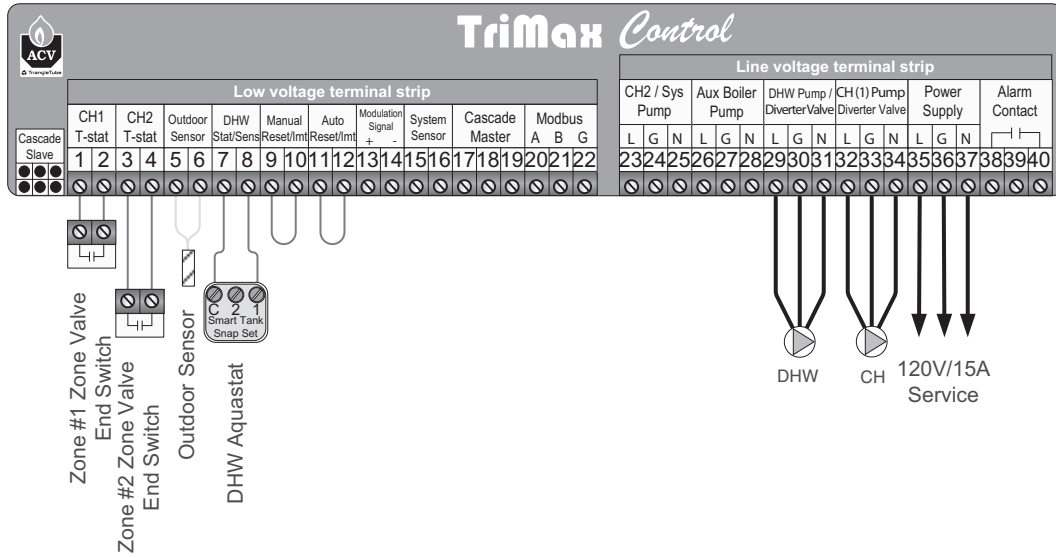

**Fig. 25: Prestige Wiring - Multiple Zone Valve with Single System/Boiler Circulator**

**Note:** Reference Fig. 12, page 22 for System Piping.

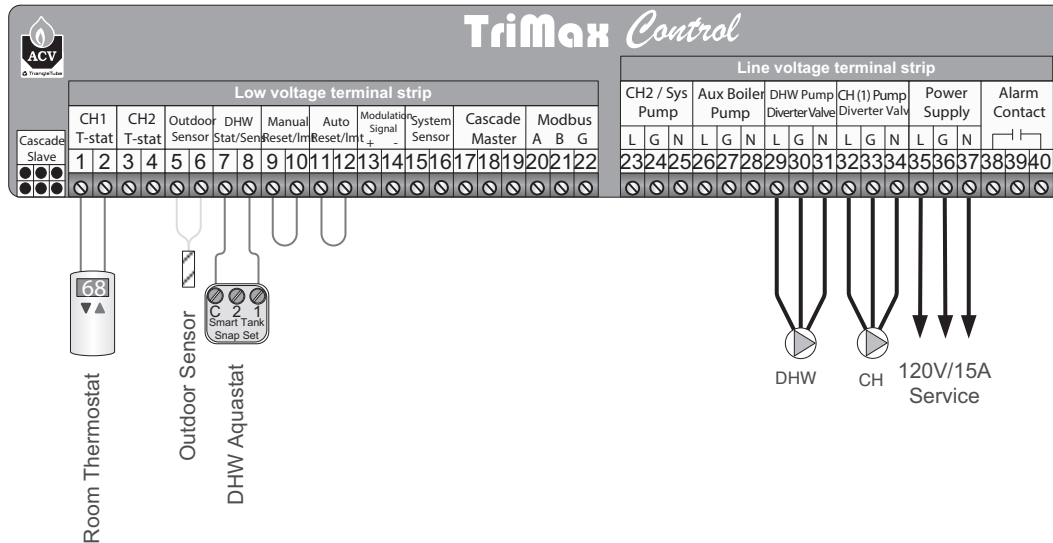

**Fig. 26: Prestige Wiring - Single Zone System with Single System/Boiler Circulator**

---

## TriMax Operation

---

### SECTION IX- TriMax Operation

The TriMax Boiler Management System is designed to be flexible yet easy to use. TriMax monitors and controls the Prestige to provide heat as efficiently as possible. TriMax includes many advanced features which previously were not available in the Prestige.

- Two central/space heating (CH) call inputs with separate outdoor reset curves.
- Domestic Hot Water (DHW) call input with optional priority.
- EZ Setup feature allows the installer to quickly customize TriMax for each installation.
- Cascade function allows up to six Prestige boilers to operate together in a single heating system.
- Modbus interface for integrating with building management systems.

All TriMax features are easy to use through a graphical display where information is presented either graphically or in plain English, so code charts are not required. Figure 30 shows a TriMax display example of the Prestige fired for a domestic hot water demand.

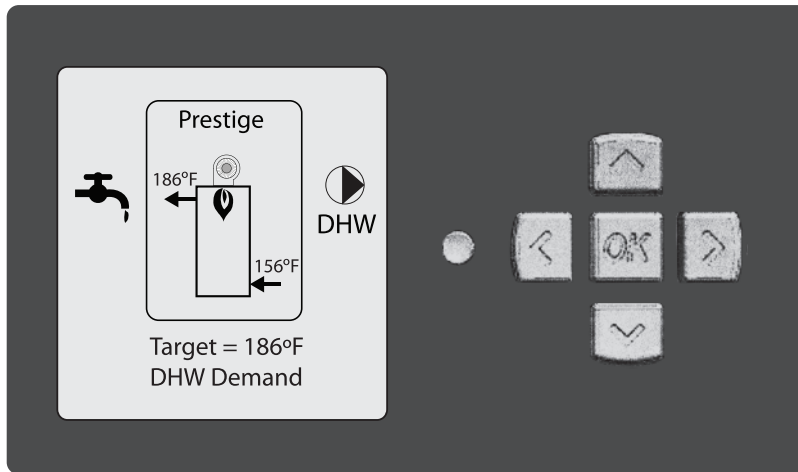



**Fig. 30: TriMax User Interface**

**TriMax Navigation**

Navigation is performed through four arrow buttons **UP**, **DOWN**, **LEFT**, **RIGHT** with a center **OK** button for making selections and entering information. The **INSTALLER** button (the small round button) provides the installing contractor with full access to all available features after entering a password. Reference the TriMax Control Supplement for Installer level functions.

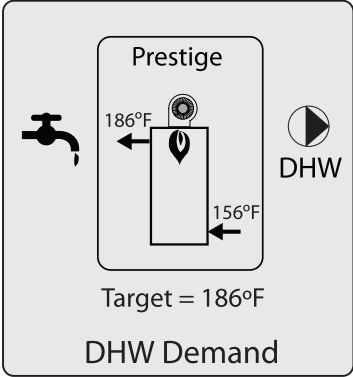

**Figure 31 – TriMax Navigation Buttons**

The Main Menu can be entered from the Home Screen by pressing the **OK** button. The menu system utilizes icons to represent each selection. The currently selected menu is displayed as a reversed image with a text description shown at the top of the display. Menus can be entered by highlighting the desired icon and pressing the **OK** button. The Home Screen  icon at the bottom of each screen returns to the Home Screen when selected. The Previous Screen  icon at the bottom of each screen returns to the previous screen when selected.

### TriMax Menu Structure

Home Screen



Main Menu

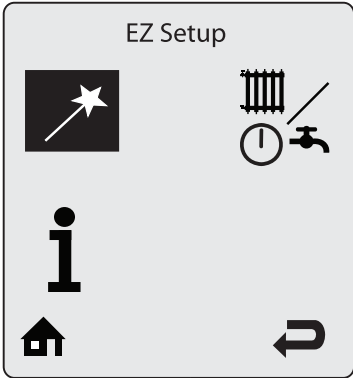

EZ Setup Menu

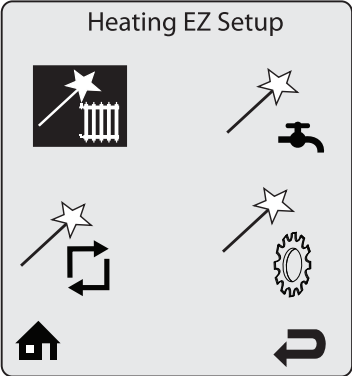

CH/DHW Operation Menu

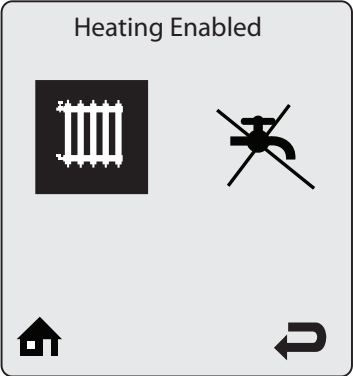

Boiler Information Menu

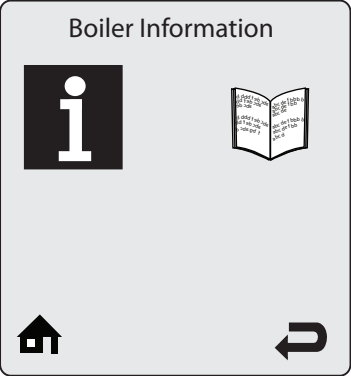



## TriMax Operation

### Home Screen

The Home Screen presents status information in a very user friendly way so that the current state of the boiler can be quickly accessed.

The Prestige is represented in the center of the Home Screen. Basic operating information such as supply and return temperatures are displayed as well as current burner status. A flame symbol is displayed when the unit is fired. The flame size changes to indicate the current firing rate.

The radiator icon indicates that a central heating call has been received. A small number 1 or 2 indicates which CH calls are active.

The faucet icon indicates that a domestic hot water call has been received.

The percentage icon indicates that an external modulation call has been received.

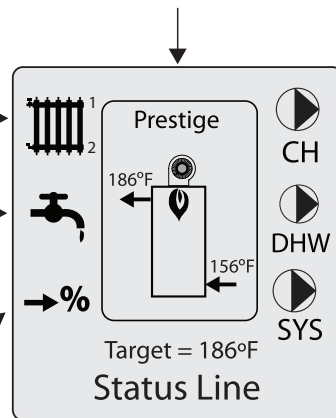

Circulator icons indicate which circulators are currently powered.

This line provides basic information. The user can press the **LEFT** or **RIGHT** arrow buttons to view Target, Supply, Return, Domestic, Outdoor and System Temperatures.

The status line displays the current operating state of the Prestige. See page 44 for a list of all Status Line Messages.

The screen backlight will illuminate when any button is pressed and remain illuminated for five minutes. Press the **UP** or **DOWN** buttons to turn on the backlight while at the Home Screen without making any changes.

The screen contrast can be adjusted at the Home Screen by pressing and holding the **OK** button then pressing and holding the **LEFT** arrow along with the **OK** button. The contrast can then be increased by pressing the **UP** button or decreased by pressing the **DOWN** button while holding in the **OK** button and **LEFT** arrow. All buttons must be released and the procedure performed again to switch between increasing and decreasing contrast.

## TriMax Operation

### Status Line Messages

Status Line Message	Description
<b>Standby</b>	Indicates that the Prestige is ready to respond when a demand is received.
<b>CH Demand</b>	A central heating call has been received.
<b>DHW Demand</b>	A domestic hot water call has been received.
<b>CH / DHW Demand</b>	Central heating and domestic hot water calls are being received simultaneously. Both calls are being satisfied simultaneously because domestic hot water priority has been disabled.
<b>DHW Priority</b>	Central heating and domestic hot water calls are being received simultaneously. Domestic hot water call is being satisfied first because it has priority over central heating calls.
<b>Priority Timeout</b>	Central heating and domestic hot water calls are being received simultaneously. The domestic hot water priority time limit has been exceeded. Priority will now switch back and forth between central heating and domestic hot water calls until one call is satisfied.
<b>External Demand</b>	An external modulation call has been received.
<b>Slave Operation</b>	The Prestige is a slave in a cascade system.
<b>Manual Operation</b>	The burner or circulators have manually been enabled in the Installer Menu.
<b>CH Burner Delay</b>	The burner will not fire until the call blocking time has elapsed.
<b>DHW Burner Delay</b>	The burner will not fire until the call blocking time has elapsed.
<b>CH Setpoint Reached</b>	The burner is not fired because the supply/system water temperature exceeds the setpoint. The central heating circulator continues to operate and the burner will fire again once the supply/system water temperature drops below the setpoint.
<b>DHW Setpoint Reached</b>	The burner is not fired because the supply/system water temperature exceeds the setpoint. The domestic circulator continues to operate and the burner will fire again once the supply/system water temperature drops below the setpoint.
<b>CH Post Pump</b>	The central heating circulator is running to remove heat from the Prestige at the completion of a call.
<b>DHW Post Pump</b>	The domestic hot water circulator is running to remove heat from the Prestige at the completion of a call.
<b>Freeze Protection</b>	The burner is fired because the freeze protection feature has been activated. Freeze protection will end once the supply/system water temperature is raised to 60°F [16°C].
<b>Boiler Protection</b>	The burner firing rate is being reduced because of an excessive difference between the boiler supply and return temperatures. The firing rate will begin increasing once the temperature difference is less than 45°F [25°C].
<b>Lockout Description</b>	The lockout which currently has the Prestige shut down is displayed.

## TriMax Operation

### Main Menu

The Main Menu can be entered from the Home Screen by pressing the **OK** button. The menu system utilizes icons to represent each selection. The currently selected menu is displayed as a reversed image with a text description shown at the top of the display. Menus can be entered by highlighting the desired icon and pressing the **OK** button.

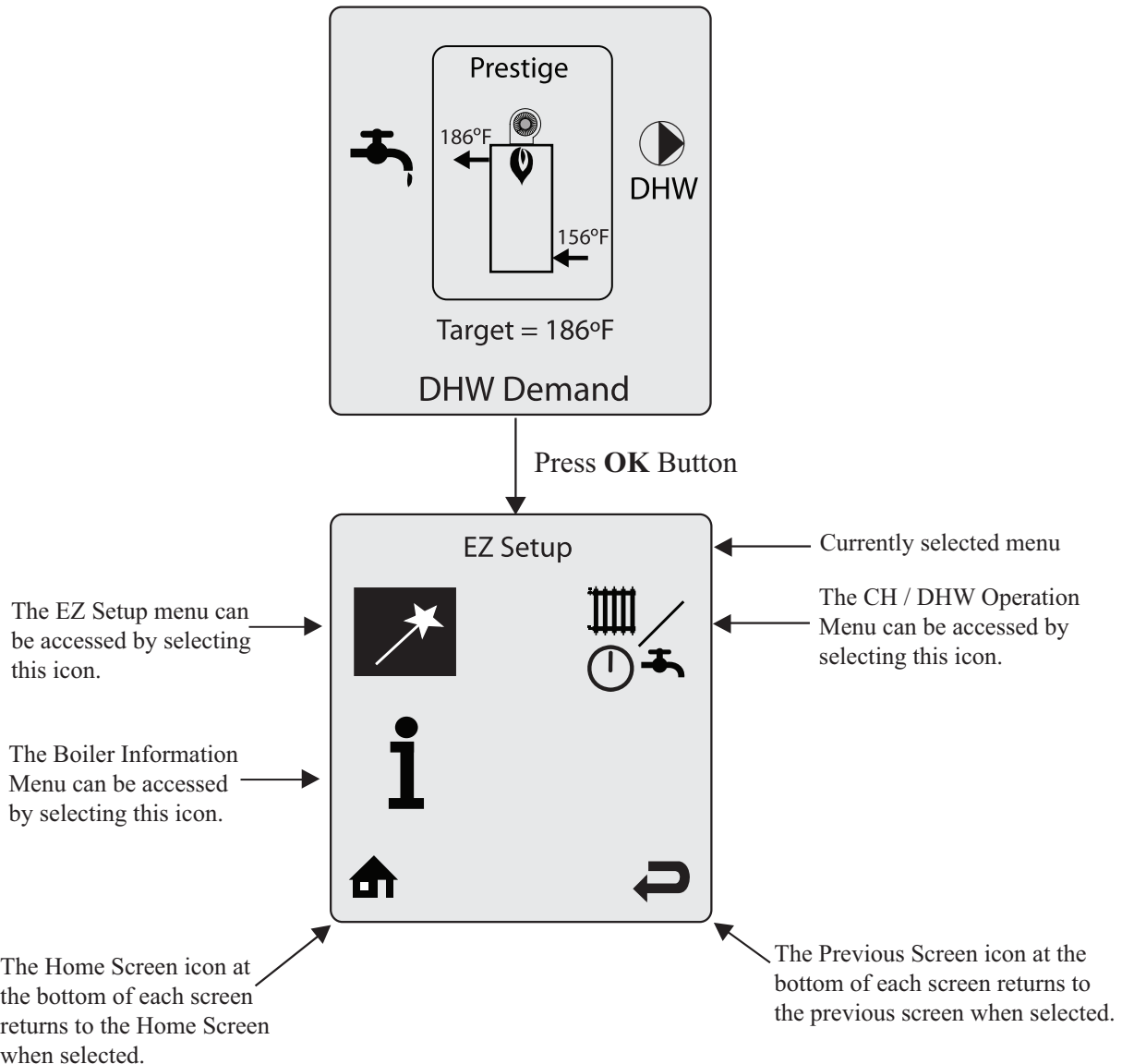

---

## TriMax Operation

---

### EZ Setup

**Navigation:** Home Screen>Main Menu>EZ Setup

The EZ Setup menus provide a simple way to quickly customize the TriMax for each installation. EZ Setup prompts the user to make selections which allows the Prestige to be setup very quickly without searching through long lists of settings and manually making adjustments.

### Heating EZ Setup



**Navigation:** Home Screen>Main Menu>EZ Setup>Heating EZ Setup

Heating EZ Setup allows the installer to quickly customize the central heating settings for the application.

#### Select CH Demand

**Default: Switch & Outdoor Reset**

Select CH Demand prompts the installer to select how a CH Demand is generated. Press the **UP** or **DOWN** buttons to select the CH Demand type then press the **OK** button to store the setting. The Select CH Demand options are:

- **Switch & Outdoor Reset** – This option is only displayed when the outdoor temperature sensor is connected. A central heating call from a thermostat or zone panel will enable the Prestige and the setpoint will vary with the outdoor temperature for central heating calls.
- **Switch & Setpoint** - This option is only displayed when the outdoor temperature sensor is not connected. A central heating call from a thermostat or zone panel will enable the Prestige and the setpoint will be fixed for central heating calls
- **Constant & Outdoor Reset** - This option is only displayed when the outdoor temperature sensor is connected. The Prestige will maintain setpoint without an external call from a thermostat or zone panel. The setpoint will vary with the outdoor temperature for central heating calls.
- **Constant & Setpoint** - The Prestige will maintain setpoint without an external call from a thermostat or zone panel. The setpoint will be fixed for central heating calls.
- **0-10V Modulation Signal** – This option allows the Prestige firing rate to be controlled by an external control system.

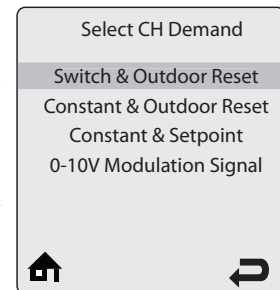

OR

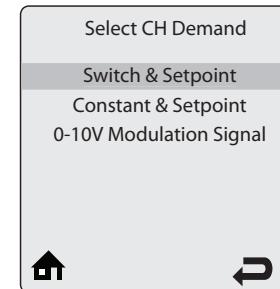

#### CH1 Setpoint

**Default: 180°F [82°C]**

CH1 Setpoint prompts the installer to enter the fixed setpoint for a CH1 heating call when a Setpoint option is chosen in Select CH Demand. Press the **LEFT** or **RIGHT** buttons to adjust the CH1 Setpoint then press the **OK** button to store the setting.

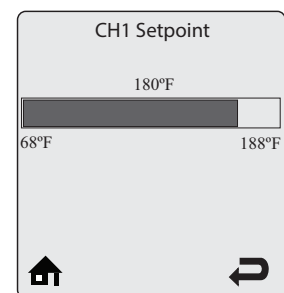

#### CH2 Setpoint

**Default: 140°F [60°C]**

CH2 Setpoint prompts the installer to enter the fixed setpoint for a CH2 heating call when a Setpoint option is chosen in Select CH Demand. Press the **LEFT** or **RIGHT** buttons to adjust the CH2 Setpoint then press the **OK** button to store the setting.

## TriMax Operation

### Select CH1 Reset Curve

**Default: Finned Tube Baseboard**

Select CH1 Reset Curve prompts the installer to select an outdoor reset curve for a CH1 heating call when an Outdoor Reset option is chosen in Select CH Demand. Outdoor reset curve presets are available to cover most applications. The outdoor reset curve can also be adjusted to any desired settings in the Installer Menu. Press the **UP** or **DOWN** buttons to select the outdoor reset curve appropriate for the type of heating system then press the **OK** button to store the setting.

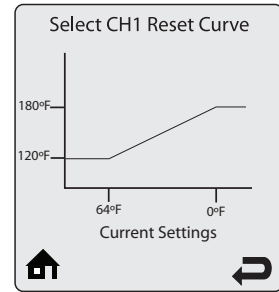

### Select CH2 Reset Curve

**Default: Low Mass Radiant**

Select CH2 Reset Curve prompts the installer to select an outdoor reset curve for a CH2 heating call when an Outdoor Reset option is chosen in Select CH Demand. Outdoor reset curve presets are available to cover most applications. The outdoor reset curve can also be adjusted to any desired settings in the Installer Menu. Press the **UP** or **DOWN** buttons to select the outdoor reset curve appropriate for the type of heating system then press the **OK** button to store the setting.

**Table 3: Outdoor Reset Preset Selections**

Preset	Minimum Setpoint	Maximum Setpoint
Low Mass Radiant	80°F [27°C]	140°F [60°C]
High Mass Radiant	80°F [27°C]	120°F [49°C]
Cast Iron Baseboard	100°F [38°C]	170°F [77°C]
Finned Tube Baseboard	120°F [49°C]	180°F [82°C]
Radiators	120°F [49°C]	170°F [77°C]
Fan Coil	140°F [60°C]	180°F [82°C]

### Set Warm Weather Shutdown Temperature

**Default: OFF**

Warm Weather Shutdown prompts the installer to enter an optional outdoor temperature at which to disable the central heating function and any circulator's placed into constant circulation with the pump constant circulation setting. The Prestige will continue to respond to a domestic hot water call or a 0-10V Modulation Signal when the outdoor temperature exceeds the Warm Weather Shutdown Temperature setting. Press the **LEFT** or **RIGHT** buttons to adjust the Warm Weather Shutdown Temperature then press the **OK** button to store the setting. The Warm Weather Shutdown icon  is displayed on the home screen when the outdoor temperature reaches the Warm Weather Shutdown Temperature.

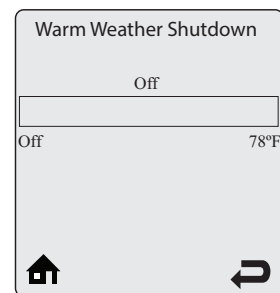

---

## TriMax Operation

---

### Domestic Hot Water EZ Setup



#### Navigation: Home Screen>Main Menu>EZ Setup>DHW EZ Setup

Domestic Hot Water EZ Setup allows the installer to quickly customize the domestic hot water settings for the application.

#### Select DHW Demand

**Default: Switch**

Select DHW Demand prompts the installer to select the type of device which will generate a DHW call. Press the **UP** or **DOWN** buttons to select the DHW Demand type then press the **OK** button to store the setting. The Select DHW Demand options are:

- **Switch** – A domestic hot water call from an aquastat or dry contact switch will enable the Prestige with a fixed setpoint for a domestic hot water call.
- **Sensor** – This option requires the use of Indirect Water Heater Sensor PSRKIT22. The Prestige will monitor the DHW storage temperature and generate a domestic hot water call when the temperature drops below the DHW Storage Setpoint by 6°F [3°C].

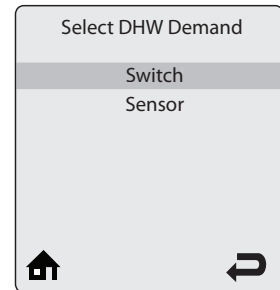

#### Boiler DHW Setpoint

**Default: 186°F [86°C]**

Boiler DHW Setpoint prompts the installer to enter the fixed boiler setpoint temperature during a Domestic hot water call when the Switch option is chosen in Select DHW Demand. Press the **LEFT** or **RIGHT** buttons to adjust the Boiler DHW Setpoint then press the **OK** button to store the setting.

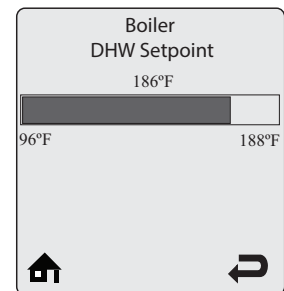

#### DHW Storage Setpoint

**Default: 140°F [60°C]**

DHW Storage Setpoint prompts the installer to enter the domestic hot water storage setpoint temperature when the Sensor option is chosen in Select DHW Demand. Press the **LEFT** or **RIGHT** buttons to adjust the DHW Storage Setpoint then press the **OK** button to store the setting.

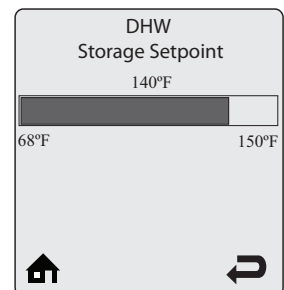

**NOTICE**

**The Boiler DHW Setpoint will automatically be set 46°F [25°C] higher than the DHW Storage Setpoint setting.**

---

## TriMax Operation

---

### DHW Priority Timeout

**Default: Off**

DHW Priority Timeout prompts the installer to enter an optional time limit that a domestic hot water call has priority over a central heating call. Press the **LEFT** or **RIGHT** buttons to adjust the DHW Priority Timeout then press the **OK** button to store the setting.

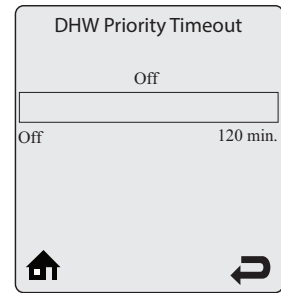

### EZ Setup Reset

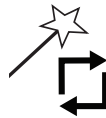

**Navigation: Home Screen>Main Menu>EZ Setup>EZ Setup Reset**

EZ Setup Reset allows the installer to reset all EZ Setup settings back to the original factory defaults. Follow the onscreen instructions to reset all EZ Setup settings back to the original factory defaults.

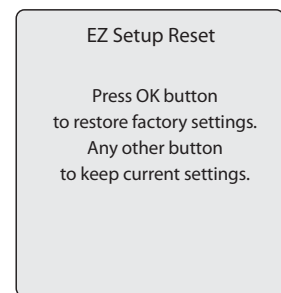

### Display EZ Setup



**Navigation: Home Screen>Main Menu>EZ Setup>Display EZ Setup**

Display EZ Setup allows the installer to select the type of temperature units displayed as well as the language used for all text. Press the **UP** or **DOWN** buttons to select then press the **OK** button to store the setting.

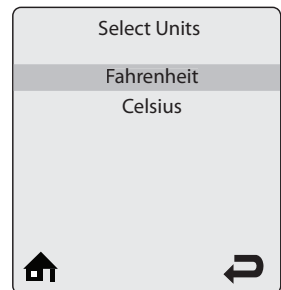

---

## TriMax Operation

---

### CH/DHW Operation

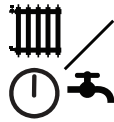

#### Navigation: Home Screen>Main Menu>CH / DHW Operation

CH / DHW Operation provides a simple way to disable either the central heating or domestic hot water functions of the Prestige. Operation can be enabled and disabled by selecting the central heating or domestic hot water icon then pressing the **OK** button to toggle between enabled and disabled. An icon with an X through it indicates that function has been disabled. The disabled icon is also displayed on the home screen when a function has been disabled.

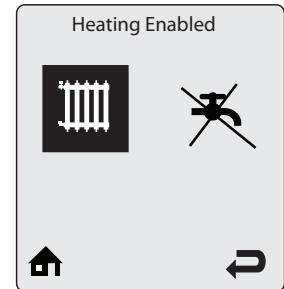

### Boiler Information



#### Navigation: Home Screen>Main Menu>Boiler Information>Boiler Information

Boiler Information provides real time operating information of the Prestige. Each line contains an information item followed by its current value. Six information items are displayed on the screen at one time. Press the **UP** or **DOWN** buttons to scroll through additional information items. See page 51 for a list of all information items.

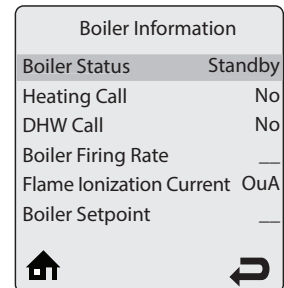

### Boiler Information Logging

Some information items include a logging function which records one sample every 12 minutes to produce a graph of the last 24 hours. Select the information item in Boiler Information then press the **OK** button to view its graph. The following items have a logging function:

- Boiler Firing Rate
- Flame Ionization Current
- Boiler Setpoint
- Boiler Supply Temperature
- Boiler Return Temperature
- Boiler Flue Temperature
- Outdoor Temperature
- DHW Storage Temperature
- External Modulation Signal

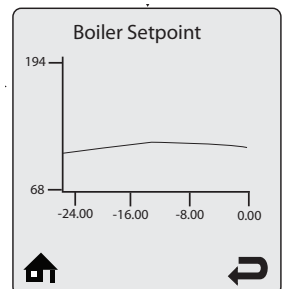



**Information Items**

<b>Information Item</b>	<b>Description</b>
<b>Boiler Status</b>	Displays the current operating state of the Prestige. This is the same as the status line on the home screen.
<b>Heating Call</b>	Displays if a central heating call is present.
<b>DHW Call</b>	Displays if a domestic hot water call is present
<b>Boiler Firing Rate</b>	Displays the current firing rate of the Prestige.
<b>Flame Ionization Current</b>	Displays the current flame ionization current from the ignitor.
<b>Boiler Setpoint</b>	Displays the current setpoint of the Prestige.
<b>Boiler Supply Temperature</b>	Displays the current supply temperature of the Prestige.
<b>Boiler Return Temperature</b>	Displays the current return temperature of the Prestige.
<b>Boiler Flue Temperature</b>	Displays the current flue temperature of the Prestige.
<b>Outdoor Temperature</b>	Displays the current outdoor temperature.
<b>DHW Storage Temperature</b>	Displays the current DHW storage temperature when Indirect Water Heater Sensor PSRKIT22 is installed.
<b>External Modulation Signal</b>	Displays the current external modulation signal being received from an external controller.
<b>CH Ignitions</b>	Displays the number of central heating ignitions since the unit was installed. This counter increases in increments of twenty.
<b>CH Runtime</b>	Displays the number of hours the Prestige has run for a central heating call since the unit was installed.
<b>DHW Ignitions</b>	Displays the number of domestic hot water ignitions since the unit was installed. This counter increases in increments of twenty.
<b>DHW Runtime</b>	Displays the number of hours the Prestige has run for a domestic hot water call since the unit was installed.

---

## TriMax Operation

---

### Lockout History



**Navigation: Home Screen>Main Menu>Boiler Information>Lockout History**

Lockout History records the last eight lockouts. Each line contains a lockout description followed by how long ago the lockout occurred. Six lockouts are displayed on the screen at one time. Press the **UP** or **DOWN** buttons to scroll through additional lockouts. See pages 54 & 55 for a list of lockouts and descriptions.

Lockout History	
1: Low water	5h ago
2: No error	25h ago
3: No error	25h ago
4: No error	25h ago
5: No error	25h ago
6: No error	25h ago

Home icon      Back icon

### Lockout Details

Some information items are recorded at the time of a lockout to aid in diagnosing the cause of the lockout. Select the lockout description in Lockout History then press the **OK** button to view the recorded information. Press the **UP** or **DOWN** buttons to scroll through the recorded information. The following information items are recorded at the time of a lockout:

- Boiler Status
- Heating Call
- Domestic Call
- Boiler Firing Rate
- Flame Ionization Current
- Boiler Setpoint
- Boiler Supply Temperature
- Boiler Return Temperature
- Boiler Flue Temperature
- Outdoor Temperature
- System Temperature

Lockout Details Low Water	
Boiler Status	Standby
Heating Call	No
DHW Call	No
Boiler Firing Rate	—
Flame ionization Current	OuA

Home icon      Back icon

## Lockout Screen

The Lockout Screen replaces the Home Screen if a lockout occurs. The screen backlight will also illuminate constantly while the Prestige is locked out. Pressing any arrow button will return to the Home Screen so that additional troubleshooting can be performed. See pages 54 and 55 for a list of lockouts and descriptions.

The lockout message is displayed at the top of the screen

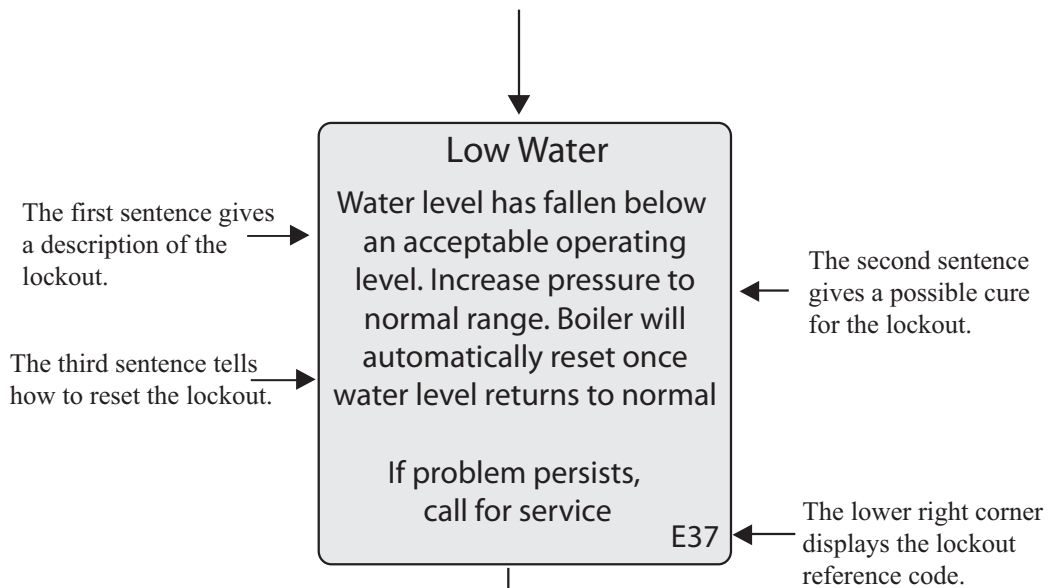

Press any **ARROW** Button

Press any **ARROW** button to return to the Home Screen while locked out. The main menu can then be entered from the Home Screen to help diagnose the problem. Select the Home Screen icon at the bottom of any menu screen to return to the Lockout Screen.

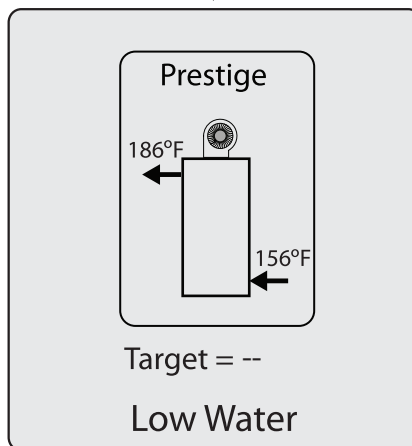

The status line now displays the lockout

**Manual Reset Hard Lockouts**

<b>Code</b>	<b>Lockout Message</b>	<b>Description</b>
<b>E1</b>	<b>Failed Ignition</b>	The burner failed to light after 5 ignition attempts.
<b>E2</b>	<b>False Flame</b>	A flame is being detected prior to ignition.
<b>E3</b>	<b>High Boiler Temperature</b>	Boiler temperature has reached 210°F [99°C]
<b>E5</b>	<b>Blower Speed</b>	Blower is not at correct speed or speed signal is not being received by control module.
<b>E8</b>	<b>Flame Circuit Error</b>	Flame circuit test failed.
<b>E9</b>	<b>Gas Valve Circuit Error</b>	Gas valve circuit test failed.
<b>E13</b>	<b>Reset Limit Reached</b>	Resets are limited to 5 every 15 minutes.
<b>E15</b>	<b>Sensor Drift</b>	Supply or return sensor reading has drifted.
<b>E16</b>	<b>Supply Sensor Stuck</b>	Supply sensor reading is not changing.
<b>E17</b>	<b>Return Sensor Stuck</b>	Return sensor reading is not changing.
<b>E18</b>	<b>Sensor Failure</b>	Supply or return sensor reading changed very rapidly.
<b>E21</b>	<b>Internal Control Fault</b>	A / D conversion error.
<b>E30</b>	<b>Supply Sensor Shorted</b>	A short circuit has been detected in the boiler supply temperature sensor circuit.
<b>E31</b>	<b>Supply Sensor Open</b>	An open circuit has been detected in the boiler supply temperature sensor circuit.
<b>E43</b>	<b>Return Sensor Shorted</b>	A short circuit has been detected in the boiler return temperature sensor circuit.
<b>E44</b>	<b>Return Sensor Open</b>	An open circuit has been detected in the boiler return temperature sensor circuit.
<b>E80</b>	<b>Return &gt; Supply</b>	Return temperature is higher than supply temperature.
<b>E87</b>	<b>External Limit Open</b>	An external manual reset limit has opened

**Automatic Reset Soft Lockouts**

<b>Code</b>	<b>Lockout Message</b>	<b>Description</b>
<b>E7</b>	<b>High Flue Temperature</b>	Flue temperature exceeds high limit.
<b>E12</b>	<b>Internal Control Fault</b>	EEPROM misconfiguration
<b>E25</b>	<b>Internal Control Fault</b>	CRC check error.
<b>E32</b>	<b>DHW Sensor Shorted</b>	A short circuit has been detected in the DHW temperature sensor circuit.
<b>E33</b>	<b>DHW Sensor Open</b>	An open circuit has been detected in the DHW temperature sensor circuit.
<b>E34</b>	<b>Low Voltage</b>	Line voltage has fallen below an acceptable operating level.
<b>E37</b>	<b>Low Water</b>	Water level has fallen below an acceptable operating level.
<b>E45</b>	<b>Flue Sensor Shorted</b>	A short circuit has been detected in the boiler flue temperature sensor circuit.
<b>E46</b>	<b>Flue Sensor Open</b>	An open circuit has been detected in the boiler flue temperature sensor circuit.
<b>E76</b>	<b>External Limit Open</b>	An external automatic reset boiler limit has opened.
<b>E81</b>	<b>Sensor Drift</b>	Supply and return temperatures are not equal.
<b>E89</b>	<b>Incorrect Setting</b>	A parameter setting is in conflict with another setting.
<b>E90</b>	<b>Firmware Mismatch</b>	Control module and display firmware versions are incompatible.
<b>E91</b>	<b>System Sensor Shorted</b>	A short circuit has been detected in the system temperature sensor circuit.
<b>E92</b>	<b>System Sensor Open</b>	An open circuit has been detected in the system temperature sensor circuit.
<b>E93</b>	<b>Outdoor Sensor Shorted</b>	A short circuit has been detected in the outdoor temperature sensor circuit.
<b>E94</b>	<b>Internal Display Fault</b>	Display memory error.
<b>E95</b>	<b>Supply Sensor Error</b>	Supply sensor reading is invalid.
<b>E96</b>	<b>Outdoor Sensor Open</b>	An open circuit has been detected in the outdoor temperature sensor circuit.
<b>E97</b>	<b>Cascade Mismatch</b>	Cascade configuration has changed.
<b>E98</b>	<b>Cascade Bus Error</b>	Communication with other boilers has been lost.
<b>E99</b>	<b>Controller Bus Error</b>	Communication between boiler display and control module has been lost.

---

## Start-Up Preparation

---

### SECTION X - Start-Up Preparation

#### **NOTICE**

**Requirements below must be met for warranty coverage of Prestige heat exchangers. A thorough cleaning of any existing system, using approved heating system cleaning agents is required prior to installation of the Prestige boiler. System should be treated with an approved inhibitor after filling for long term protection.**

#### Check Boiler System Fluid Chemistry

#### **WARNING**

**Do not use petroleum-based cleaning or sealing compounds in the boiler system. Damage to seals and gaskets in the system components could occur, resulting in substantial property damage.**

#### **NOTICE**

**System fluid including additives must be practically non-toxic, having a toxicity rating or Class of 1, as listed in Clinical Toxicology of Commercial Products.**

#### Boiler Fluid pH Level 6.0 to 8.0

Maintain the boiler fluid pH between 6.0 and 8.0. Check using litmus paper or contact a water treatment company for a chemical analysis.

If the pH does not meet this requirement, do not operate the PRESTIGE Solo or leave the unit filled until the condition is corrected.

#### Boiler Fluid Hardness Less Than 7 Grains

For areas with unusually hard water (hardness above 7 grains) consult a water treatment company.

#### Chlorinated Water

Do not use the PRESTIGE Solo to heat a swimming pool or spa directly.

Maintain the chlorine level of the water at levels considered safe for drinking.

#### Flush Boiler to Remove Sediment

The installer must flush the boiler system to remove any sediment to allow proper operation of the PRESTIGE Solo .

Flush the systems until the water runs clean and is free of sediment.

For zoned systems, each zone should be flushed through a purge valve. Purge valves and isolation valves should be installed on each zone to allow proper flushing of the system.

#### Cleaning of Old Boiler/System:

- Drain the existing system.
- Fill system with fresh water and cleaner, place existing boiler in operation and run all zones.
- Follow manufacturer's instructions for proper cleaner concentration and proper cleaning time.
- Thoroughly drain and flush system with fresh water after cleaning.
- Install new boiler, fill system with fresh water and proper amount of inhibitor.
- Verify pH and inhibitor level per inhibitor manufacturer's specs; add inhibitor if necessary.

#### Cleaning of New Boiler/System:

- Install new boiler and flush system with cleaner water to remove any debris.
- Fill system with fresh water and proper amount of inhibitor.
- Verify pH and inhibitor level per inhibitor manufacturer's specs; add inhibitor if necessary.

---

## Start-Up Preparation

---

### Check and Test Antifreeze

For boiler systems containing antifreeze solutions, follow the antifreeze manufacturer's instructions in verifying the inhibitor level and to ensure the fluid characteristics are within specification requirements.

Due to the degradation of inhibitors over time, antifreeze fluids must be periodically replaced. Refer to the manufacturer of the antifreeze for additional instructions.

### Use of Antifreeze in the Boiler System

 **WARNING**

**NEVER use automotive or ethylene glycol antifreeze or undiluted antifreeze in the primary system as freeze protection. This can cause severe personal injury, death or substantial property damage if ignored.**

Determine the antifreeze fluid quantity using the system water content volume and following the antifreeze manufacturer instructions.

The water volume of the PRESTIGE Solo 110 is approximately 3 gallons [12 L]. Remember to include the volume of the expansion tank.

Check with local codes requirements for the installation of backflow preventers or actual disconnection from the boiler's cold water fill or make up water supply line.

**NOTICE**

**Massachusetts Code requires the installation of a backflow preventer if antifreeze is used.**

Ensure the concentration of antifreeze to water does not exceed a 50/50 ratio.

**NOTICE**

**System fluid including additives, must be practically non-toxic, having a toxicity rating or Class of 1, as listed in Clinical Toxicology of Commercial Products.**

### Filling the Boiler System

1. Close the boiler drain valve located on the bottom of the unit and any manual or automatic air vent in the system.
2. Open all system isolation valves.
3. Fill the boiler system to correct system pressure. Correct pressure will vary with each application.

**NOTICE**

**Typical residential system fill pressure is 12 psi. System pressure will increase when system temperature increases. Operating pressure of the system should never exceed 25 psi.**

4. Purge air and sediment in each zone of the boiler system through the purge valve. Open air vents to allow air to be purged in the zones.
5. Once the system is completely filled and purged of all air and sediment, check the system pressure and check/repair any leaks.

 **WARNING**

**Unrepaired system leaks will cause continual makeup water to be added to the boiler. Continual makeup water will cause mineral buildup within the heat exchanger, reducing the heat transfer, causing possible heat buildup and eventual heat exchanger failure.**

---

## Start-Up Preparation

---

### Check Low Water Cut-Off Device

- The PRESTIGE Solo is provided with a factory installed LWCO device that measures system pressure of more than 10 psi.
- Remove the front jacket panel and check for continuity across the low water cut-off device wire terminals. The contacts should be closed when system pressure is greater than 10 psi. See item 6, on Fig. 34 page 78 for location of the LWCO.

### Check For Gas Leaks

 **WARNING**

**Prior to start-up and during initial operation, smell near the floor and around the unit for gas odorant or any unusual odor. Do not proceed with the start-up if there is any indication of a gas leak. Any leaks found must be repaired immediately.**

 **WARNING**

**Propane installations only - The propane supplier mixes an odorant with the propane to make its presence detectable. In some cases the odorant can fade and the gas may no longer have an odor.**

**Prior to start-up of the unit and periodically after start-up have the propane supplier check and verify the odorant level.**

### Check Thermostat Circuit

- Disconnect the external thermostat wires from the low voltage terminal strip.
- Connect a voltmeter across the wire ends of the external thermostat wiring.
- Close each thermostat, zone valve and relay in the external circuit one zone at a time and check the voltage reading across the wire ends.

- There should **NEVER** be voltage measured at the wire ends.
- If voltage is measured at the panel under any condition, check and correct the external wiring.

**NOTICE**

**In systems using 3-wire zone valves, backfeed of voltage to the unit is a common problem. Use an isolation relay to prevent voltage from the external circuit entering the PRESTIGE Solo control panel.**

- Reconnect the external thermostat wires to the low voltage terminal strip.

### Inspection of Condensate Drain Assembly

1. Inspect and ensure the Condensate Drain Assembly is properly installed as described on page 24 and shown in Fig. 14 on page 25.
2. Remove the plug from the Condensate Drain Assembly and fill with fresh water.

**NOTICE**

**The condensate drain assembly must be filled with water when the PRESTIGE Solo is in operation. The condensate drain assembly prevents flue gas emissions from entering the condensate line. Failure to ensure trap is filled with water could result in severe personal injury or death.**

3. Re-Install plug in condensate drain assembly.



---

## Start-Up Procedures

---

### SECTION XI - Start-Up Procedures

#### Final Checks Before Start-Up

- Read page 40 through 55 regarding the operation of the TriMax Boiler Management System.
- Verify the PRESTIGE Solo and the boiler system are full of water and all system components are correctly set for operation, including the minimum flow rate through the boiler, see page 84.
- Verify Start-up Preparation items outlined on pages 56 thru 58 have been completed.
- Verify all electrical connections are correct and securely fastened.
- Inspect vent and combustion air piping for signs of deterioration from corrosion, physical damage or sagging. Verify combustion air and vent piping are intact and correctly installed and supported. Reference the PRESTIGE Solo vent supplement.
- Verify burner configuration - Propane only.
  - Check for proper labeling on the gas valve and the rating label for propane configuration.
  - If there is doubt on the burner configuration, remove the gas valve and check for proper propane gas orifice size: 0.204" (5.2 mm). Refer to Fig. 16, page 29 for location of the propane gas orifice.
- Ensure the vent Condensate Drain Assembly is filled with water.

#### PRESTIGE Solo Start-Up

1. Press the ON-OFF button located on the front control panel to the OFF position. Turn ON the electrical supply/service to the unit.
2. Read and follow the Operating Instructions outlined on page 63.

#### If PRESTIGE Solo Does Not Start Correctly

1. Check for loose electrical connections, blown fuses, (on control module and in terminals) or an open service switch.
2. Verify CH and DHW operation is enabled. A radiator or faucet icon with an X through it indicates that function is disabled.
3. Check continuity across the LWCO device for a closed circuit. See item 6 on Fig. 34, page 78.
4. Is an external limit control (if applicable) open? Ensure the external limit is reset to the closed position.
5. Are the gas supply valves open at the unit and meter?
6. Is incoming gas supply pressure at the unit more than 5" w.c. and less than 13" w.c. for natural or propane with all gas appliances ON or OFF.
7. Are the heating thermostats set above room temperature?

If none of these conditions correct the problem, refer to the PRESTIGE Solo Trouble-Shooting Guide or contact ACV-Triangle Tube Technical Support.

#### Check the PRESTIGE Solo and System

- Check Boiler Piping.

Check Boiler system piping and components for leaks. If found, shut down the unit and repair immediately.

Purge any remaining air from the system piping. Air in the system piping will interfere with circulation creating heat distribution problems and system noise.

## Start-Up Procedures

- Check Vent Piping and Combustion Air Piping.

Check for gas-tight seal at every connection and seam of the venting and combustion air piping.

### WARNING

**Venting system must be sealed gas-tight to prevent flue gas spillage and potential carbon monoxide emissions, which will result in severe personal injury or death.**

- Check Gas Piping

Check around the unit for gas odor following the procedure outlined in this manual on Page 58.

### WARNING

**If any gas leaks are found or suspected, shut the unit down immediately. Use a gas detection device or bubble test to locate the source of the gas leak and repair at once. Do not operate the unit until the leak is corrected. Failure to comply with this procedure could result in severe personal injury, death or substantial property damage.**

- Verify Flame Pattern and Combustion

1. Check the flame pattern through the inspection port of the heat exchanger. The flame should be blue and stable. The flame should be the length of the burner head openings.

### WARNING

**The combustion testing and adjustments must be performed by a qualified installer, service agency or the gas supplier. All combustion measurements must be performed with calibrated equipment to ensure proper reading and accuracy.**

2. Test for CO<sub>2</sub> or O<sub>2</sub> and for CO during high firing rate. The combustion readings should be within the range listed in Table 4. **The CO level should not exceed 100 ppm when combustion is correct.** Perform the following procedure to manually place the burner into high fire.

- a. Press the round **INSTALLER** button. Reference Fig. 31, page 41.
- b. Enter the installer access code “054” by using the **LEFT** and **RIGHT** buttons to select a digit and the **UP** and **DOWN** buttons to change the digit. Press the **OK** button to enter the access code.
- c. Press the **RIGHT** button to highlight the Manual Operation icon  then press the **OK** button.
- d. Press the **OK** button while the FAN icon is highlighted to manually fire the burner and power the CH circulator.

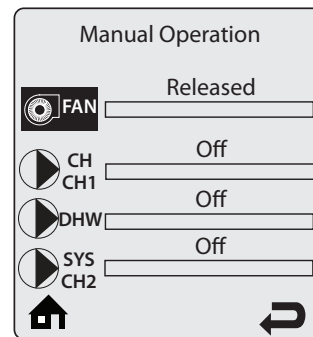

### NOTICE

**An adequate CH load must be present to dissipate the heat generated during the combustion test. If an adequate CH load is not available, an indirect water heater can be used to dissipate the heat by creating a DHW call which will enable the DHW circulator.**

## Start-Up Procedures

- e. Press the **LEFT** and **RIGHT** buttons to adjust the firing rate from 1% to 100%. Hold down the **LEFT** or **RIGHT** button to rapidly increase or decrease the firing rate.

**Table 4: Recommended Combustion Levels**

	Natural Gas	Propane
O2 Min.	2.30%	2.70%
O2 Max.	5.30%	4.70%
CO2 Min.	8.80%	10.70%
CO2 Max.	10.50%	12.00%
CO Max.	100 ppm	100 ppm

- f. Press the **OK** button while the FAN icon is highlighted to shutdown the burner.
- g. Cycle power to the Prestige once combustion testing is complete to return to normal operation.

 **WARNING**

**The combustion levels should be measured at high firing rate. If the combustion levels are not within the range given in Table 4 for the firing rate, shut the boiler down and contact ACV-Triangle Tube Technical Support. Failure to comply with this requirement could result in severe personal injury, death or substantial property damage.**

If the combustion levels during high fire (100%) is outside the recommended combustion settings adjust the **THROTTLE SCREW** (see Fig. 16 page 29) as follows:

**Counter-clockwise adjustment of the throttle screw at High Fire:**

O<sub>2</sub> decreases and CO<sub>2</sub> increases

**Clockwise adjustment of the throttle screw at High Fire:**

O<sub>2</sub> increases and CO<sub>2</sub> decreases

- Once the combustion level is set at high fire (100%), manually place the boiler into low fire (1%) mode by pressing the **LEFT** button to adjust firing rate down.
- If the CO<sub>2</sub> combustion level during low fire (1%) is not within +/- 0.2 of the combustion level measured at high fire, adjust the plastic **OFFSET SCREW** under the cover screw on the top of the gas valve (see Fig. 16 page 29).

**Counter-clockwise adjustment of the OFFSET SCREW at Low Fire:**

O<sub>2</sub> increases and CO<sub>2</sub> decreases

**Clockwise adjustment of the OFFSET SCREW at Low Fire:**

O<sub>2</sub> decreases and CO<sub>2</sub> increases

**Measure Input - Natural Gas Only**

- Ensure the boiler is firing at maximum firing rate. To manually place the boiler into high fire mode, reference page 60.
- Operate the unit for approximately 10 minutes.
- Turn off all gas appliances within the building, except the **PRESTIGE Solo**.
- At the gas meter, record the time required to use one cubic foot of gas.
- Calculate Natural gas input using the following equation:  

$$3600 \times 1000 / \text{number of second recorded for one cubic foot of gas} = \text{BTU/H.}$$
- The BTU/H calculated should approximate the input rating listed on the unit.







---

## Start-Up Procedures

---

### ☐ Test High Temperature Limit

The high temperature limit can be temporarily lowered from 210°F [99°C] to 102°F [39°C] for testing.

1. Press the round **INSTALLER** button. Reference Fig. 31, page 41.
2. Enter the installer access code “054” by using **LEFT** and **RIGHT** buttons to select a digit and the **UP** and **DOWN** buttons to change the digit. Press the **OK** button to enter the access code.
3. Press the **OK** button while CH & DHW Settings icon  is highlighted.
4. Press the **DOWN** button to highlight the Boiler Settings icon  then press the **OK** button.
5. Press the **DOWN** button to highlight Lockout Temperature then press the **OK** button.
6. Press the **UP** button to highlight 102°F [39°C] then press the **OK** button.
7. Press the **DOWN** button twice to highlight the Home Screen icon  then press the **OK** button.
8. Initiate a CH or DHW call and confirm that a High Boiler Temperature lockout occurs once the supply temperature reaches 102°F [39°C].
9. Press any **ARROW** button to return to the Home Screen.
10. Press the round **INSTALLER** button.
11. Press the **OK** button while the CH & DHW Settings icon  is highlighted.
12. Press the **DOWN** button to highlight the Boiler Settings icon  then press the **OK** button.
13. Press the **DOWN** button to highlight Lockout Temperature, then press the **OK** button.
14. Press the **DOWN** button to highlight 210°F [99°C] then press the **OK** button.
15. Press the **DOWN** button twice to highlight the Home Screen icon  then press the **OK** button.
16. Press the **OK** button to reset the lockout and return the unit to service.

## Start-Up Procedures

### FOR YOUR SAFETY READ BEFORE LIGHTING





#### WARNING

If you do not follow these instructions exactly, a fire or explosion may result causing property damage, personal injury or loss of life.

- A. This appliance does not have a pilot. It is equipped with an ignition device which automatically lights the burner. **DO NOT** try to light the burner by hand.
- B. BEFORE OPERATING, smell all around the appliance area for gas. Be sure to smell next to the floor because some gas is heavier than air and will settle on the floor.  
**WHAT TO DO IF YOU SMELL GAS**
  - Do not try to light any appliance.
  - Do not touch any electric switch; do not use any phone in your building
  - Immediately call your gas supplier from a neighbor's phone. Follow the gas supplier's instructions.
- If you cannot reach your gas supplier, call the fire department.
- C. Use only your hand to turn the external manual gas valve. Never use tools. If the valve will not turn by hand, don't try to repair it; call a qualified service technician. Force or attempted repair may result in a fire or explosion.
- D. Do not use this appliance if any part has been under water. Immediately call a qualified service technician to inspect the appliance and to replace any part of the control system and any gas control which has been under water.

### OPERATING INSTRUCTIONS

1. **STOP!** Read the safety information above. This appliance is equipped with an ignition device which automatically lights the burner. **DO NOT** try to light the burner by hand.
2. Set room thermostat(s) to lowest setting. Turn the external manual gas valve handle clockwise  "CLOSE" (valve handle shall be perpendicular to gas piping).
3. Turn the service switch on the PRESTIGE control panel OFF.
4. Remove the front jacket panel on the unit.
5. Turn the external manual gas valve handle counter clockwise  to "OPEN" gas supply (valve handle shall be parallel to gas piping).
6. Wait five (5) minutes to clear out any gas. If you then smell gas in the jacket enclosure or around the unit, **STOP!** Follow "B" in the safety information above. If you don't smell gas, go to the next step.
7. Turn the service switch on the PRESTIGE control panel "ON".
8. Set room thermostat(s) to desired setting(s).
9. The PRESTIGE control panel display will show the current operating status on the Status Line at the bottom of the screen. "Standby" means there is no call for heat (all thermostats are satisfied). "CH Demand" indicates a space heating call has been received. "DHW Demand" indicates a domestic hot water call has been received. A flame icon will be displayed when the unit is fired.
10. If the unit will not operate with a call for heat and the system piping is not hot, follow the instructions "To Turn Off Gas to Appliance", below and call your service technician or gas supplier.
11. Replace the front jacket panel. Make sure the panel is seated firmly in place and all mounting screws are tightened.

### TO TURN OFF GAS TO APPLIANCE

1. Set the room thermostat to lowest setting.
2. Turn the service switch on the PRESTIGE control panel to "OFF"
3. Turn the external manual gas valve handle clockwise  to "CLOSE".

---

## Outdoor Reset Control

---

### SECTION XII - Outdoor Reset Control

The use of the outdoor reset function is required to optimize boiler efficiency, see notice below. If the outdoor sensor is not installed before turning on the boiler, an Outdoor Sensor Open error (E96) will be displayed. The error will not prevent the boiler from operating. The error will automatically reset once the outdoor sensor is installed or if the outdoor reset function is disabled. Reference TriMax Operation - EZ Setup section for information on disabling the outdoor reset function. The outdoor reset function can only be disabled if the boiler installation meets one of the exceptions listed in the notice.

#### Mounting the Outdoor Sensor

1. The exterior wall selected for mounting the outdoor sensor should represent the heat load of the building. Typically a northern or northeastern wall will suit most buildings. A southern facing wall for those buildings, which may have large glass walls or windows on the southern face.
2. Ensure the outdoor sensor is shielded from direct sunlight or the effects of heat or cold from other sources (exhaust fans, appliance vents...) to prevent false temperature sensing.
3. Mount the outdoor sensor at an elevation on the exterior wall to prevent accidental damage or tampering.

4. Avoid mounting the outdoor sensor in areas subjected to excessive moisture.
5. Once an area on the exterior wall has been determined, follow the mounting instructions included with the outdoor sensor.

#### Wiring the Sensor

1. Connect 18 AWG 2-wire cable or similar cable to the outdoor sensor.
2. Route the cable back to the PRESTIGE Solo boiler, ensuring the wires are not run parallel to telephone or power cables.

**NOTICE**

**If the sensor wires are located in an area with sources of potential electromagnetic interference (EMI) the sensor wires should be shielded or the wires should be routed in a grounded metal conduit. If using shielded cable, the shielding should be connected to the common ground of the unit.**

3. Connect the outdoor sensor wires to the outdoor sensor terminals on the low voltage terminal strip located inside the boiler enclosure (see Fig. 19 page 31). The outdoor sensor wires do not have polarity.

### IMPORTANT

In accordance with Section 325 (f) (3) of the Energy Policy and Conservation Act, this boiler is equipped with a feature that saves energy by reducing the boiler water temperature as the heating load decreases. This feature is equipped with an override which is provided primarily to permit the use of an external energy management system that serves the same function.

**THIS OVERRIDE MUST NOT BE USED UNLESS AT LEAST ONE OF THE FOLLOWING CONDITIONS IS TRUE.**

- An external energy management system is installed that reduces the boiler water temperature as the heating load decreases.
- This boiler is not used for any space heating
- This boiler is part of a modular or multiple boiler system having a total input of 300,000 BTU/hr or greater.
- This boiler is equipped with a tankless coil.

---

## External Modulating Control

---

### SECTION XIII - External Modulating Control

The boiler can directly accept an analog 0-10 VDC signal to control the firing rate from an external modulating boiler controller such as the Optima SCC4.

#### Wiring the Modulating Controller

Run two 18 gauge wires from the external modulating boiler controller's 0-10 VDC boiler output to the modulation signal terminals on the low voltage terminal strip inside the boiler. (see boiler wiring diagram, Fig. 19 page 31). This signal will both enable and modulate the boiler. No wiring is required at the thermostat terminals.

**NOTICE**

**Ensure that the polarity of the connections from the external modulating boiler controller to the boiler are correct. Reversed polarity will lead to no response from the boiler.**

#### TriMax Adjustment

The TriMax control must be programmed to accept the 0-10 VDC signal from the external modulating boiler control.

1. Use the Heating EZ Setup function to set the CH Demand to 0-10V Modulation Signal. Reference page 46 for the Heating EZ Setup function.

#### Programming of External Modulating Control

The external modulating control must be programmed to send 2 VDC to enable the boiler and run it at low fire, and 10 VDC to run the boiler at high fire. Once the control enables the boiler, it must wait 30 seconds to allow the burner to stabilize before modulating the boiler.

## External Modulating Control

### Factory TriMax Setting

<u>HEATING SETTING</u>	<u>FACTORY DEFAULT</u>	<u>EZ SETUP RESET</u>	<u>INSTALLER RESET</u>
Heating Operation	Enabled		✓
Demand	Switch & Outdoor Reset	✓	✓
Absolute Max CH Setpoint	188°F [87°C]		✓
CH1 Maximum Setpoint	180°F [82°C]	✓	✓
CH1 Minimum Setpoint	120°F [49°C]	✓	✓
Reset Curve Coldest Day	0°F [-18°C]		✓
Reset Curve Warmest Day	64°F [18°C]		✓
CH2 Circuit	Enabled		✓
CH2 Maximum Setpoint	140°F 60°C]	✓	✓
CH2 Minimum Setpoint	80°F [27°C]	✓	✓
Warm Weather Shutdown	OFF	✓	✓
Pump Constant Circulation	Disabled		✓
CH Post Pump Time	1 minute		✓
Freeze Protection	Enabled		✓
Frost Protection Setpoint	-22°F [-30°C]		✓
Parallel Shift Value	0°F [0°C]		✓
CH Call Blocking	1 minute		✓
System Pump	CH1/CH2		✓
<u>DOMESTIC SETTING</u>	<u>FACTORY DEFAULT</u>	<u>EZ SETUP RESET</u>	<u>INSTALLER RESET</u>
DHW Operation	Enabled		✓
Demand	Switch	✓	✓
Boiler DHW Setpoint	186°F [86°C]	✓	✓
DHW Storage Setpoint	140°F [60°C]	✓	✓
DHW On Differential	6°F [3°C]		✓
DHW Storage Adder	46°F [25°C]		✓
DHW Post Pump Time	1 minute		✓
DHW Priority Timeout	OFF	✓	✓
DHW Priority	Enabled		✓
DHW Call Blocking	0 minute		✓
DHW to CH Call Blocking	1 minute		✓
Antilegionella Function	Disabled		✓
<u>BOILER SETTING</u>	<u>FACTORY DEFAULT</u>	<u>EZ SETUP RESET</u>	<u>INSTALLER RESET</u>
Prestige Model	Solo		✓
Lockout Temperature	210°F [99°C]		✓
Modbus Address	0=BCST		✓



---

## Check-Out Procedures

---

### SECTION XIV- Check-Out Procedures

<b>NOTICE</b>
---------------

**Perform the following check-out procedures as outlined and check off items as completed. When procedures are completed, the installer should complete the installation record on page 68.**

#### Check-Out Procedures

- Boiler system fluid chemistry checked and verified as outlined on page 56.
- Boiler system was completely flushed to remove any debris/sediment.
- Any automatic air vents placed within the system are open one full turn.
- Air is purged from the heating zones and boiler system piping.
- If applicable, confirm that the burner has been properly configured for Propane as outlined on page 28.
- Thermostat circuit wiring checked and verified that no voltage is present to the low voltage terminals as outlined on page 58.
- Operating Instructions on page 63 were followed during start-up.
- Combustion levels and flame pattern verified as outlined on page 60.
- Measured the rate of input on Natural Gas as outlined on page 61.
- Test high temperature limit as outlined on page 62.
- Checked the incoming gas pressure to the PRESTIGE Solo to ensure a minimum pressure of 5" w.c during flow conditions to all gas appliances and a maximum pressure of 13" w.c during non-flow conditions for Natural and Propane.
- Adjusted balancing valves and system limit controls to provide design temperatures to the primary space heating system.
- In multiple zone applications, adjusted for correct flow of boiler water to each zone.
- Checked and verified room thermostat(s) function properly and the thermostat(s) heat anticipator (if used) was properly set.
- Observed several operating cycles for proper operation of the PRESTIGE Solo and the system.
- Set the room thermostat(s) to the desired room temperature.
- Reviewed all instructions shipped with the PRESTIGE Solo with the homeowner or maintenance personnel.
- Completed the Installation Record on page 68.
- Ensure all manuals and other documents are returned to the Installation envelope and given to the owner for safekeeping.

---

**Installation Record**

---

**SECTION XV - Installation Record**

PRESTIGE Model Number: \_\_\_\_\_

Serial Number: \_\_\_\_\_

Date of Installation: \_\_\_\_\_

Fuel:     Natural Gas     Propane

Measured Rate of Input: \_\_\_\_\_ Btu/hr

Combustion Readings:

CO<sub>2</sub>    \_\_\_\_\_ %

O<sub>2</sub>    \_\_\_\_\_ %

CO    \_\_\_\_\_ ppm

The following items were completed during installation:

- Installation instructions have been followed and completed
- Check-out procedures have been followed and completed
- Information regarding the unit and installation received and left with owner / maintenance personnel.

Installer Information

(Company) \_\_\_\_\_

(Address) \_\_\_\_\_

(Address) \_\_\_\_\_

(Phone Number) \_\_\_\_\_

---

## Maintenance Schedules

---

### SECTION XVI - Maintenance Schedule

#### Service Technician

At least on an annual basis the following maintenance should be performed by a qualified service technician:

#### General

- Attend to any reported problems.
- Inspect the interior of the boiler jacket area; clean and vacuum if necessary.
- Clean the condensate drain assembly and fill with fresh water.
- Check boiler fluid pH on systems.
- Check for leaks: water, gas, flue and condensate.
- Verify flue vent piping/gaskets and air inlet piping are in good condition, sealed tight and properly supported.
- Check boiler water pressure, piping and expansion tank.
- Check control settings.
- Check ignition electrode (sand off any white oxide; clean and reposition).
- Check ignition wiring and ground wiring.
- Check all control wiring and connections.
- Check burner flame pattern (stable and uniform).

Additional items if combustion or performance is poor:

- Clean heat exchanger and flue ways.
- Remove burner assembly and clean burner head using compressed air only.

Once the maintenance items are completed, review the service with the owner.

#### Owner Maintenance

Periodically:

- Check the area around the unit.
- Check and remove any blockage from the combustion air inlet and ventilation openings.
- Check the temperature and pressure gauges.

Monthly:

- Check vent piping.
- Check combustion air inlet piping.
- Check the pressure relief valve.
- Check the condensate drain system.

Every 6 months:

- Check boiler piping and gas supply piping for corrosion or potential signs of leakage.
- Operate the pressure relief valve.



**Follow the maintenance procedures given throughout this manual. Failure to perform the service and maintenance or follow the directions in this manual could result in damage to the PRESTIGE Solo or in system components, resulting in severe personal injury, death or substantial property damage.**

---

## Maintenance Procedures

---

### SECTION XVII- Maintenance Procedures

#### Maintenance Procedures

 **WARNING**

The PRESTIGE Solo should be inspected and serviced annually, preferably at the start of the heating season, by a qualified service technician. In addition, the maintenance and care of the unit as outlined on page 69 and further explained on pages 70 through 75 should be performed to assure maximum efficiency and reliability of the unit. Failure to service and maintain the PRESTIGE Solo and the system components could result in equipment failure, causing possible severe personal injury, death or substantial property damage.

**NOTICE**

The following information provides detailed instruction for completing the maintenance items outline in the maintenance schedule on page 69. In addition to this maintenance, the PRESTIGE Solo should be serviced at the beginning of the heating season by a qualified service technician.

#### Reported Problems

Any problems reported by the owner should be checked, verified and corrected before proceeding with any maintenance procedures.

#### Check Surrounding Area

Verify that the area surrounding the PRESTIGE Solo is free of combustible / flammable materials or flammable vapors or liquids. Remove immediately if found.

Verify that combustion air inlet area is free of any contaminants. Refer to the materials listed on page 5 of this manual. If any of these products are in the area from which the unit takes its combustion air, they must be removed immediately or the combustion air intake must be relocated to another area.

#### Inspect Burner Area

Remove the boiler front jacket panel and venturi inlet elbow.

Vacuum any dirt or debris from the burner/blower components.

Check the burner plate mounting nuts for tightness.

Check burner plate gasket for discoloration or damage.

Re-install venturi inlet elbow and front jacket panel when completed.

 **WARNING**

Do not use solvents to clean any of the burner components. The components could be damaged, resulting in unreliable or unsafe operation.

#### Check System Piping

Inspect all piping (water and gas) on the boiler system for leaks and verify that the piping is leak free and properly supported.

Inspect the fittings and components on the unit and verify they are leak free.

 **WARNING**

Eliminate all boiler water system leaks. Continual fresh make-up water will reduce the heat exchanger life causing boiler failure. Leaking water may also cause severe property damage to the surrounding area. Inspect the gas supply piping using the procedure outlined on Page 60.

---

## Maintenance Procedures

---

### Clean Condensate Drain Assembly

1. Loosen the retaining nut from the condensate drain assembly and disconnect the assembly from the boiler.
2. Empty any water from the trap and drain assembly. Flush with fresh water as necessary to clean.
3. Check the drain piping from the condensate drain assembly to the drain. Flush to clean as necessary.
4. Reassemble the condensate drain assembly onto the boiler by tightening the retaining nut with rubber seal onto the boiler. Hand tight only.
5. Remove the fill plug on the condensate drain assembly and fill with water. See Fig. 14 on page 25.
6. Replace the fill plug on drain assembly.

### Check Ventilation Air Openings

Verify that all ventilation openings to the mechanical room or building are open and unobstructed. Check the operation and wiring of any automatic ventilation dampers.

Check and verify the vent discharge and the combustion air intake are free of debris and obstructions.

### Inspect Vent and Combustion Air Piping

Visually inspect the venting system and combustion air piping for blockage, deterioration of gasket or leakage. Repair any deficiencies.

Verify that the combustion air inlet piping is connected, sealed and properly supported.



**Failure to inspect the vent system and combustion air inlet piping and to have any conditions repaired, can result in severe personal injury or death.**

### Check Boiler System

Verify all system components are correctly installed and operating properly.

Check the cold fill pressure for the system, typical cold water fill pressure is 12 psig.

Verify the system pressure, as the unit operates at high temperature, to ensure the pressure does not exceed 25 psig. Excessive pressure reading indicates expansion tank sizing is incorrect or system performance problems.

Inspect air vent and air separators in the system. Remove the caps on automatic air vents and briefly depress the valve stem to flush vent. Replace the cap when completed. Ensure vents do not leak, replace any leaking vents.

Verify boiler fluid pH level is between 6.0 and 8.0.

Check and verify inhibitor /antifreeze concentration within the boiler water meets inhibitor/antifreeze manufacturer's specifications.

If necessary contact a boiler water treatment company for a chemical analysis.

---

## Maintenance Procedures

---

### Check Expansion Tank

Refer to Section IV - Boiler Piping for recommended location of the expansion tank and air eliminators.

#### Closed -Type Tank:

- Ensure tank is partially filled with water leaving an air gap as a cushion. Refer to the manufacturer's instruction for proper fill level.
- Ensure the tank is fitted with a device that reduces gravity circulation of air-saturated tank water back into the system. This device prevents air from bubbling up through the water as it returns from the system.
- Ensure no automatic air vents are used in the system. This will allow air to escape from the system instead of returning to the tank.

#### Diaphragm Tank:

- Ensure the system contains a minimum of one automatic air vent. Recommended location of the air vent should be atop an air eliminator.
- Remove the tank from the system and check the charge pressure. For residential applications the charge pressure is typically 12 psig. If tank does not hold a charge pressure, then the membrane is damaged and the tank should be replaced.

### Check Boiler Relief Valve

Inspect the relief valve and lift the lever to verify flow at least annually or as recommended on the warning tag of the valve.



**Before manually operating the pressure relief valve, ensure the discharge piping is directed to a suitable place of disposal to avoid a potential scald hazard. The discharge piping must be full size without restriction and installed to permit complete drainage of both the valve and line.**

If after closing the valve, the valve fails to seat properly or continually weeps, replace the relief valve. Ensure the cause of the relief valve to weep is the valve itself, not due to system over-pressurization caused by an expansion tank that is waterlogged or undersized.

### Inspection of Ignition Electrode

Remove the ignition electrode from the burner mounting plate.

Remove any white oxides accumulated on the electrode using fine grit sandpaper or steel wool. If the electrode does not clean to a satisfactory condition, replace the ignitor.

When replacing the ignition electrode, ensure the gasket is in good condition and correctly positioned, replace gasket if necessary.

### Check Ignition Wiring and Ground Wiring

Inspect the ignition cable from the ignitor to the TriMax control module.

Inspect the ground wire from the ignitor to the boiler jacket ground terminals.

Ensure wiring is in good condition and securely connected.

Check ground continuity of the wiring to the boiler jacket or piping using a continuity meter.

Replace and correct ground wire if ground continuity is not completed and satisfactory.

---

## Maintenance Procedures

---

### Check Control Wiring

Inspect all control wiring. Ensure wiring is in good condition and properly connected.

### Check Control Settings

1. Review all boiler settings in the Heating & DHW EZ Setup menus. Adjust settings as necessary, see page 46-49
2. Check any external limit control settings (if used). Adjust settings as necessary.

### Perform Start-up and Checkout Procedures

Start the unit and perform the start-up procedure as listed in this manual.

Verify the cold water fill pressure is correct and the operating pressure of the boiler is within normal operating range.

Complete the checkout procedures as referenced in this manual.

### Check Burner Flame

Inspect the burner flame through the observation port on the heat exchanger.

If flame pattern is not fully blue and covers the entire burner surface during high fire, shut the unit down and allow it to cool thoroughly before disassembly.

Close the external manual gas valve on the gas supply line and disconnect the gas piping and gas valve wire harness connector.

Disconnect the wiring harness connectors from the blower and remove the blower retaining screws or nuts. Remove the blower from the unit.

Remove the mounting nuts securing the burner mounting plate to the heat exchanger and set aside.

Carefully remove the burner mounting plate assembly from the heat exchanger. Ensure combustion chamber insulation is not damaged during removal of burner mounting plate assembly. See WARNING on page 75.

Remove the burner head mounting screws and remove the burner head. Inspect the burner head for deterioration. Use compressed air or a vacuum to clean the burner head.

Remove the venturi and gas valve assembly from the blower.

Use a vacuum cleaner or compressed air to clean the interior of the blower assembly. Inspect the blower blades to ensure they are clean and not damaged.

Re-assemble the venturi and gas valve onto the blower. Ensure the venturi gasket is in good condition, positioned correctly and replace gasket if necessary.

Re-assemble the burner head onto the burner mounting plate. Ensure the burner head gasket is in good condition, positioned correctly and replace gasket if necessary.

Re-assemble the burner mounting plate assembly onto the heat exchanger. Ensure the burner plate gasket and combustion chamber insulation is in place and not damaged, replace gasket and insulation if necessary. See WARNING on page 75.

Re-assemble the blower onto the burner mounting plate and reconnect the wiring harness connectors.

Re-assemble the gas supply connection and wire harness to gas valve. Open the external manual gas valve. Check gas piping for any leaks as outlined on page 58 and repair if necessary. Place the unit back into service.

---

## Maintenance Procedures

---

### Check Flame Signal

The flame signal can be read from the Boiler Information screen. It should be a min. 1 $\mu$  A –DC.

Check the ignitor for fouling or damaged insulation if a low flame signal is read.

Check ground wiring and continuity as a cause for low flame signal. Replace ignitor if conditions are satisfactory.

### Check Combustion Levels

Refer to page 60 of this manual for measuring combustion levels and burner adjustments.

### Check Flue Gas Temperature

1. Manually place the boiler into high fire. See page 60 for procedure.
2. Navigate to the Boiler Information Menu to observe the flue gas temperature. See page 50 for procedure.
3. If the flue gas temperature is more than 54°F [30°C] above the supply water temperature, shut the boiler down and follow the heat exchanger cleaning procedure below.

### Clean Heat Exchanger

1. Shut down the boiler:
  - Follow the instructions on Page 63 "To Turn Off Gas to Appliance"
  - Do not drain the boiler unless the boiler will be subject to freezing conditions.
  - Do not drain the boiler if freeze protection fluid is used in the system.
2. Allow the boiler to cool down to room temperature before servicing.
3. Disconnect the gas piping and gas valve wire harness connector.

4. Disconnect the wiring harness connectors from the blower and remove the blower retaining screws or nuts. Remove the blower from the unit.
5. Remove the mounting nuts securing the burner mounting plate to the heat exchanger and set aside.
6. Carefully remove the burner mounting plate assembly from the heat exchanger. Ensure combustion chamber insulation is not damaged during removal of burner mounting plate assembly. See WARNING on page 75.
7. Carefully remove the combustion chamber insulation from the heat exchanger and set aside. See WARNING on page 75.
8. Use compressed air or water to remove any accumulation from the heat exchanger flue ways.
9. Re-install the combustion chamber insulation onto the heat exchanger.
10. Re-assemble the burner mounting plate assembly onto the heat exchanger. Ensure the burner plate gasket and combustion chamber insulation is in place and not damaged, replace gasket and insulation if necessary. See WARNING on page 75.
11. Re-assemble the blower onto the burner mounting plate and reconnect the wiring harness connectors.
12. Reconnect the gas piping and wire harness to gas valve. Check for leaks, repair if necessary.
13. Close isolation valves on the boiler water piping to isolate the boiler from the heating system.
14. Attach a hose to the boiler drain valve and flush the boiler thoroughly with fresh water by using the purge valves to allow water to enter through the make-up water line to the boiler.



---

## Maintenance Procedures

---

15. Once the boiler has been completely flushed, return the boiler and system piping back to operation.
16. Perform the required startup and checkout procedures as outlined on pages 56 to 67.

### Review With Owner

Ensure the owner understands the importance to perform the maintenance schedule specified in this manual.

Remind the owner of the importance to call a licensed contractor should the unit or system exhibit any unusual behavior.

### Handling Previously Fired Combustion Chamber Insulation

 **WARNING**

**The combustion chamber insulation contains ceramic fibers, which are classified as a possible human carcinogen. When exposed to extremely high temperatures, the ceramic fibers, which contain crystalline silica, can be converted into cristobalite.**

#### Avoid Breathing and Contact with Skin and Eyes

When removing or repairing the combustion chamber insulation follow these precaution measures:

1. Use a NIOSH approved respirator which meets OSHA requirements for cristobalite dust, similar to N95. Contact NIOSH at 1-800-356-4676 or on the web at [www.cdc.gov/niosh](http://www.cdc.gov/niosh) for latest recommendations.

2. Wear long sleeved, loose fitting clothing, gloves and eyes protection.
3. Assure adequate ventilation.
4. Wash with soap and water after contact.
5. Wash potentially contaminated clothes separately from other laundry and rinse washing machine thoroughly.
6. Discard used insulation in an air tight plastic bag.

#### NIOSH Stated First Aid:

Eye/Skin: Immediately irrigate

Breathing: Clean fresh air

---

## Replacement Parts

---



**Replacement parts must be purchased through a local ACV-Triangle Tube distributor. When ordering part please provide the model number and description and/or part number of replacement part. Use only genuine ACV-Triangle Tube replacement parts to ensure warranty coverage and to avoid damage to appliance and improper operation of appliance. Contact ACV-Triangle Tube at 856-228-8881 or [www.triangletube.com](http://www.triangletube.com) for list of distributors nearest you.**

## Replacement Parts

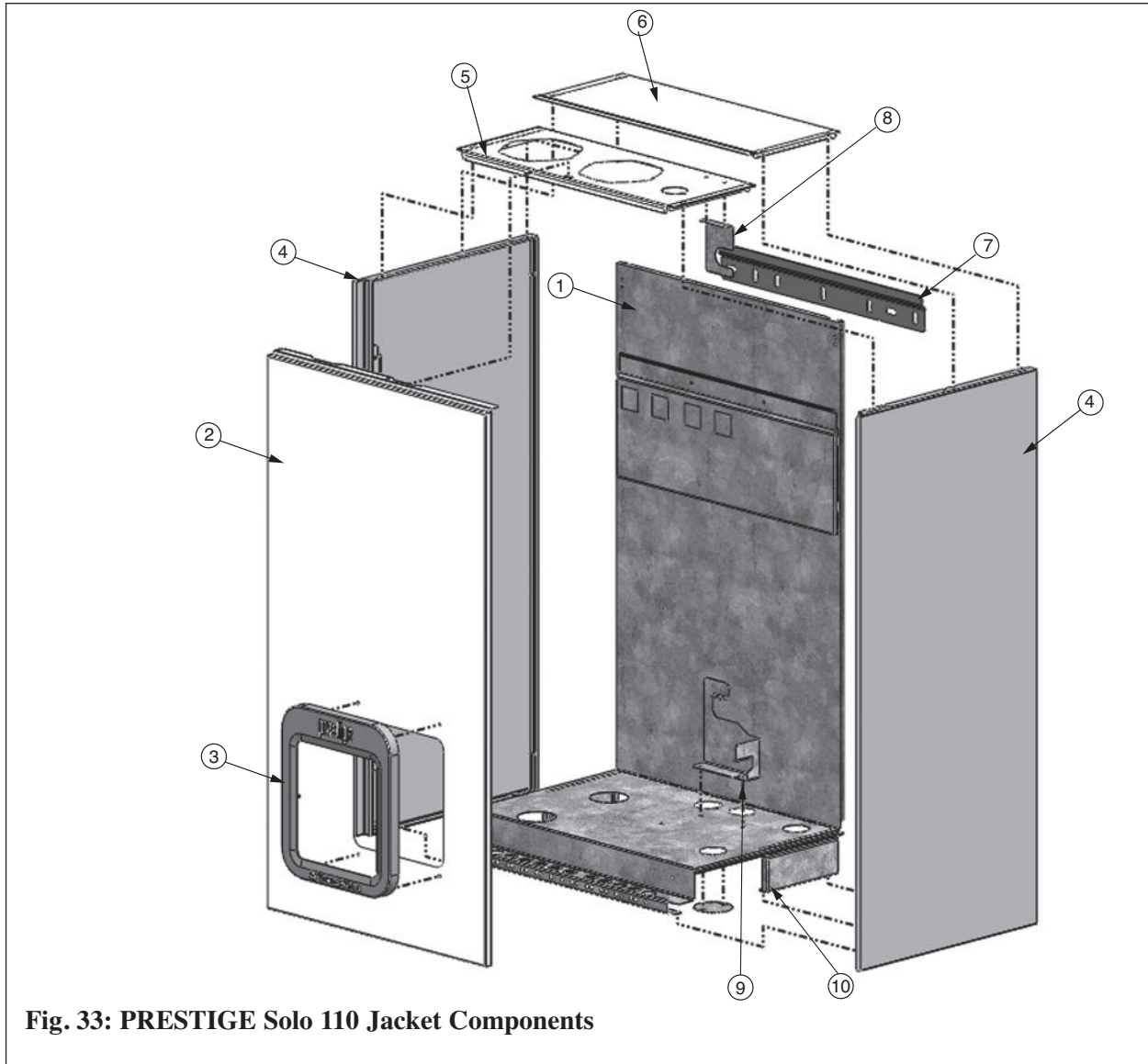

**Fig. 33: PRESTIGE Solo 110 Jacket Components**

Item	Part #	Description
1	PTJKT10R	Rear Panel
2	PTJKT08F	Front Jacket Panel
3	PTRKIT129	Control Enclosure Bezel
4	PTJKT22S	Side Jacket Panel (Left or Right)
5	PTJKT14T	Top Jacket Panel
6	PTJKT18T	Top Jacket Access Panel
7	PSRKIT21	Wall Mounting Bracket with Hardware
8	PTJKTSUP02	Support - Boiler Supply Piping
9	PTJKTSUP03	Support - Boiler Return Piping
10	PTJKTSUP01	Support - Jacket

## Replacement Parts

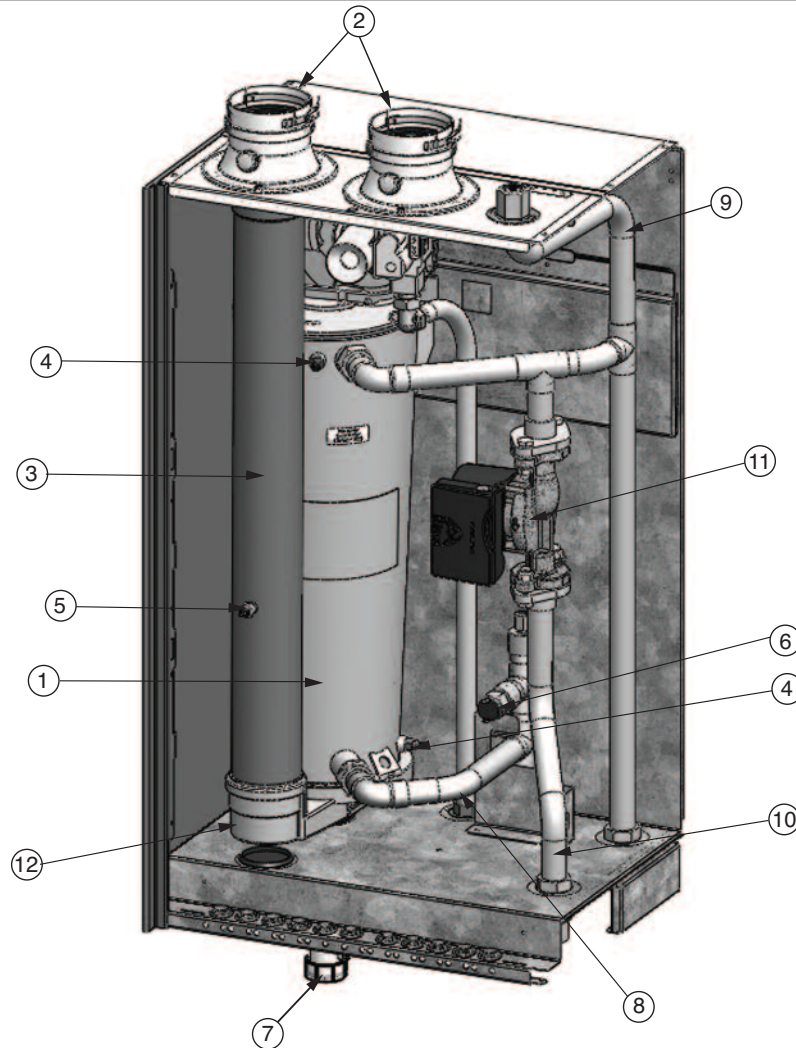

**Fig. 34: PRESTIGE Solo 110 Internal Components**

Item	Part #	Description
1	PTRKIT124	Heat Exchanger Body - Natural
	PTRKIT125	Heat Exchanger Body - Propane
2	PTADPT07	Vent Outlet/ Combustion Air Inlet Adapter
3	PTRKIT115	Polypropylene Vent Pipe
4	PTRKIT122	Supply / Return Temperature Sensor
5	PTRKIT123	Flue Temperature Sensor
6	PGRKIT20	LWCO Pressure Device
7	PSRKIT05	Condensate Drain Assembly
8	PSRKIT06	Boiler Piping - Return Assembly
9	PSRKIT08	Boiler Piping - Supply Long Assembly
10	PSRKIT07	Boiler Piping - Supply Short Assembly
11	HMCIR01	Circulator
12	PTRKIT119	Polypropylene Condensate Pan

# Replacement Parts

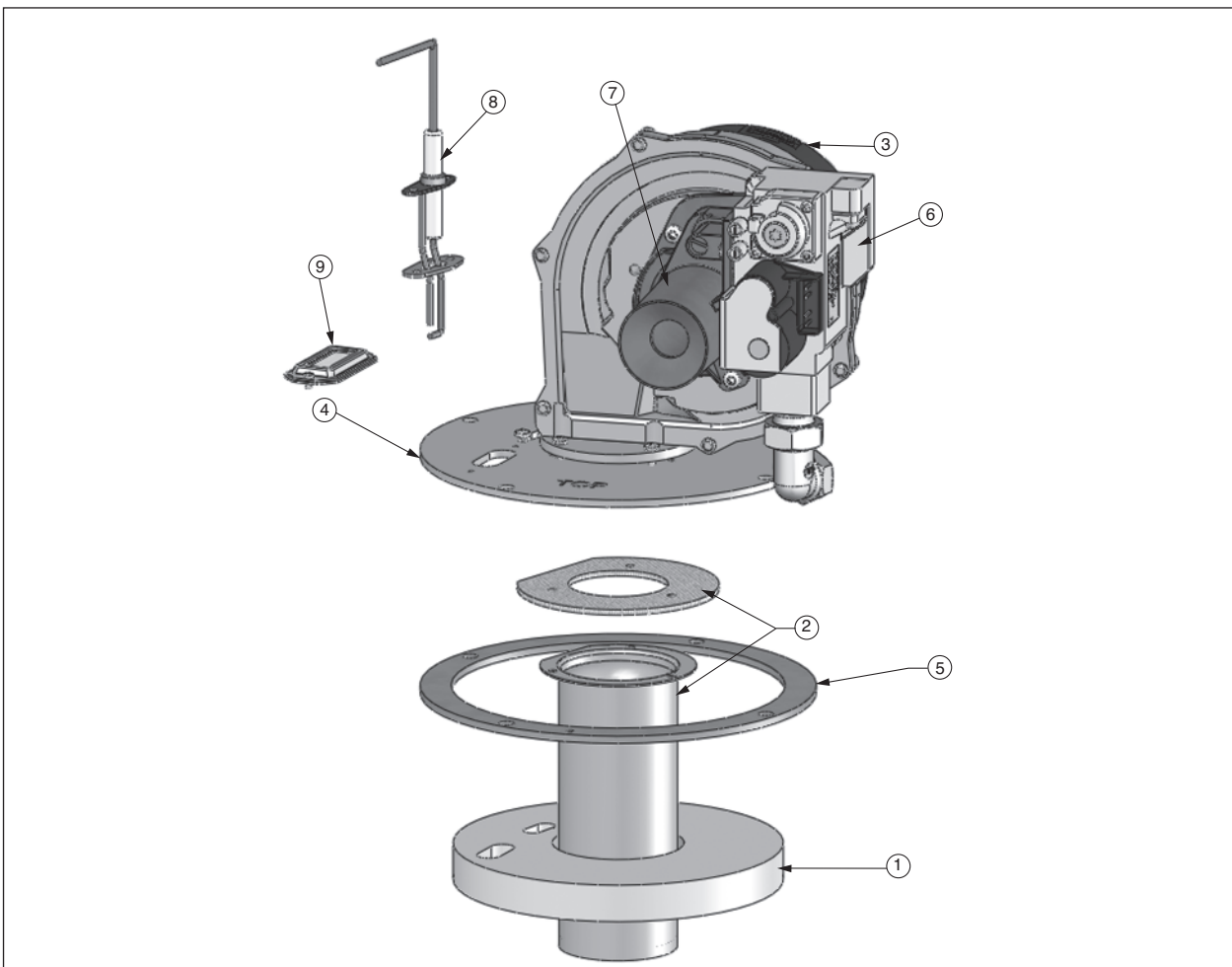

**Fig. 35: PRESTIGE Solo 110 Burner Components**

Item	Part #	Description
1	PSRKIT09	Combustion Chamber Insulation
2	PSRKIT10	Burner Head with Gasket - Natural
	PSRKIT11	Burner Head with Gasket - Propane
3	PTRKIT114	Blower with Gasket
4	PSRKIT12	Burner Plate
5	PSGSK15	Burner Plate Gasket
6	PTRKIT111	Gas Valve
7	PSRKIT81	Venturi - 002
8	PTRKIT313	Igniter and Cable with Gasket
9	PSRKIT16	Sight Glass Assembly (Glass, Gasket and Bracket)

## Replacement Parts

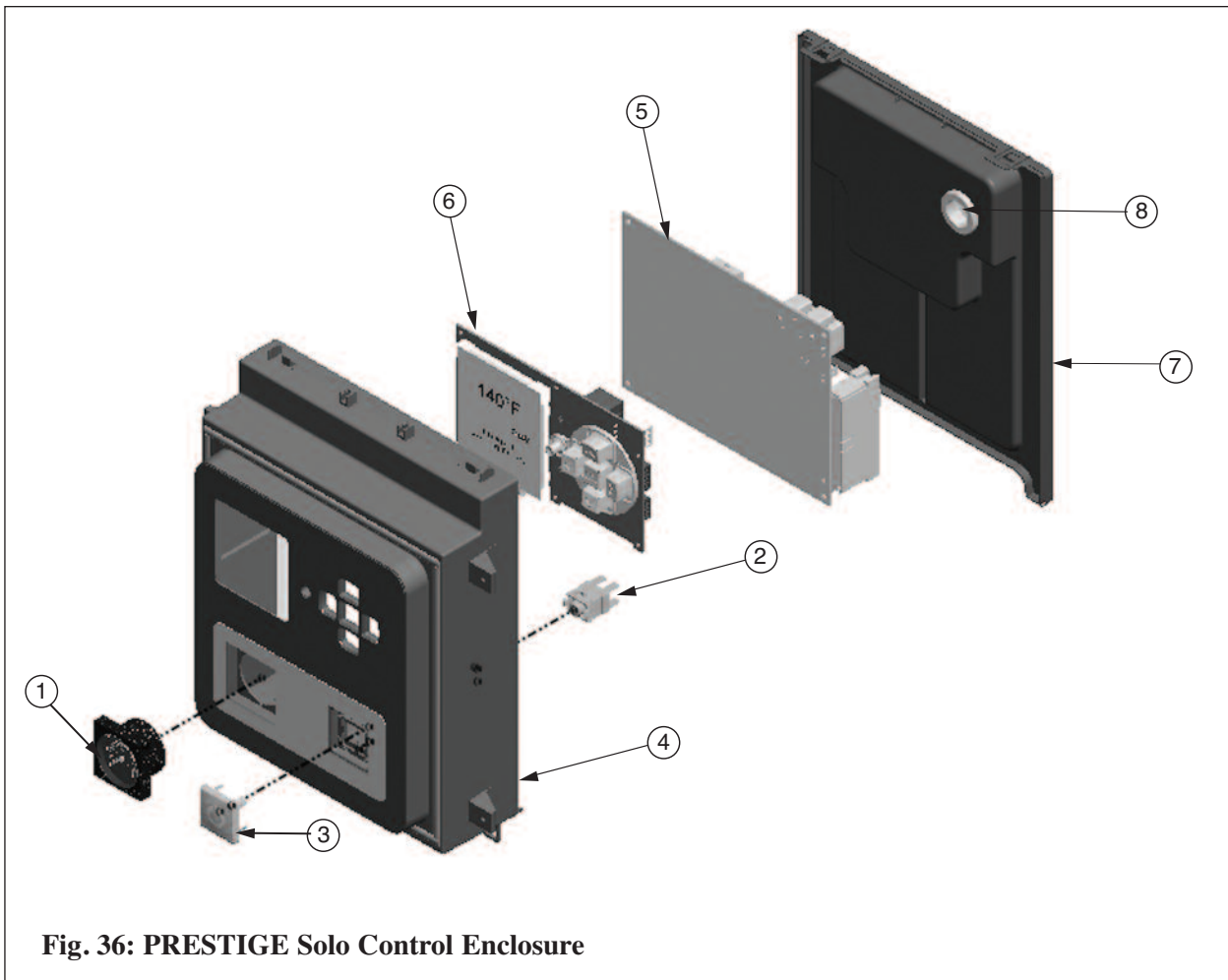

**Fig. 36: PRESTIGE Solo Control Enclosure**

Item	Part #	Description
1	PTRKIT109	Pressure Gauge and Fitting
2	PTSWI01	Power Switch
3	PTSWI02	Power Switch Cover
4	PTRKIT108	Control Enclosure
5	PTRKIT205	TriMax Control Module
6	PTRKIT207	TriMax Display Module
7	PTCON19	Control Enclosure Cover
8	PTGRO01	Igniter Cable Grommet
9	PTFUSE02	TriMax Control Module 5A Fuse (Not Shown)
10	PTFUSE01	Circulator 2.5A Fuses (Not Shown)
11	PTFUSE03	In-Line Voltage 8A Fuse (Not Shown)

**Product Specifications**

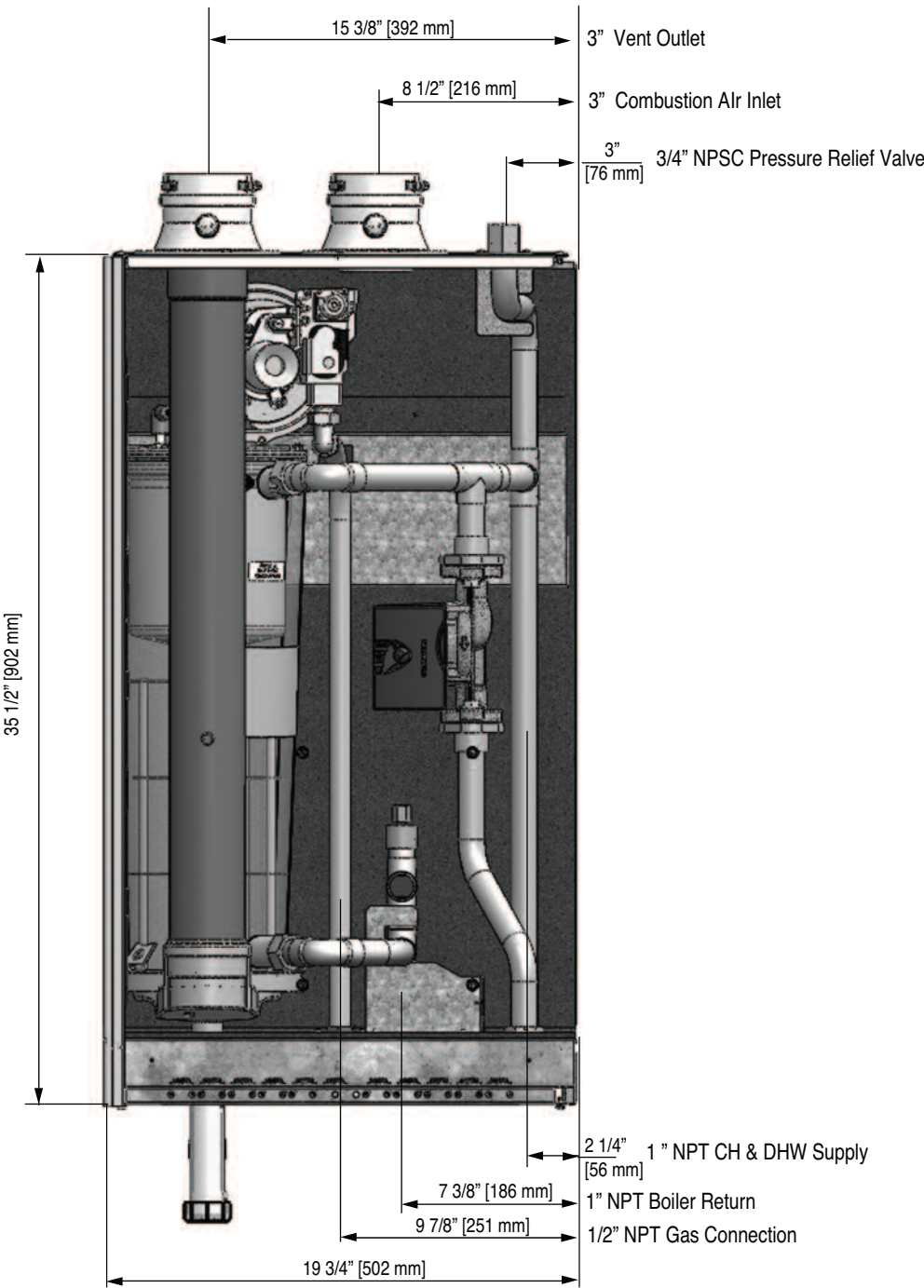

**Front View PRESTIGE Solo 110**

**Product Specifications**

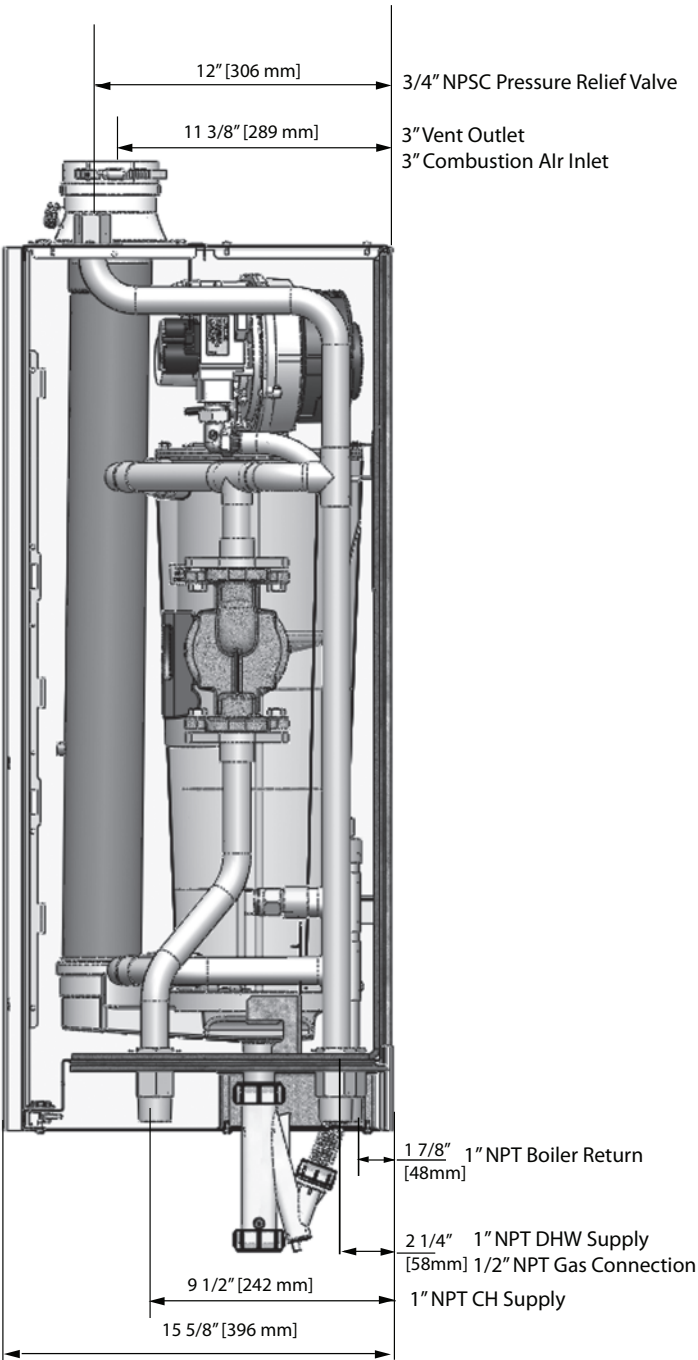

**Side View PRESTIGE Solo 110**



# Product Specifications

Boiler Model	Fuel	DOE Heating Capacity Note 1 & 4	Input Note 4	Net AHRI Rating Note 2	DOE Seasonal Efficiency AFUE Note 3	Shipping Weight Lbs/Kg
SOLO 110	Natural	99,000	110,000	86,000	95%	106/48
SOLO 110	Propane	87,000	97,000	76,000	95%	106/48

**Note 1:** The heating capacity of the PRESTIGE Solo 110 is based on the test requirements of the U.S. Department of Energy.

**Note 2:** The AHRI rating is based on a piping and pick up allowance of 1.15. This allowance should be sufficient for the standard radiation requirements for a building load.

**Note 3:** Based on the given AFUE the PRESTIGE Solo 110 meets the energy efficiency guidelines established by Energy Star.

**Note 4:** Input and output ratings are shown for sea level applications. The PRESTIGE Solo automatically derates the input at approximately 2% for every 1,000 Ft. of altitude. No alterations to the boiler or burner system is required.



**Product Specifications**

**Graph 2: Pressure Drop Comparison Solo 110 vs Grundfos UPS 15-58F**

Delta T	GPM	Available System Head in Feet		
		Spd1	Spd 2	Spd 3
20	8.7	---	---	4.5
30	5.8	1.7	7.7	11.2
40	4.3	4.7	10.9	14.2

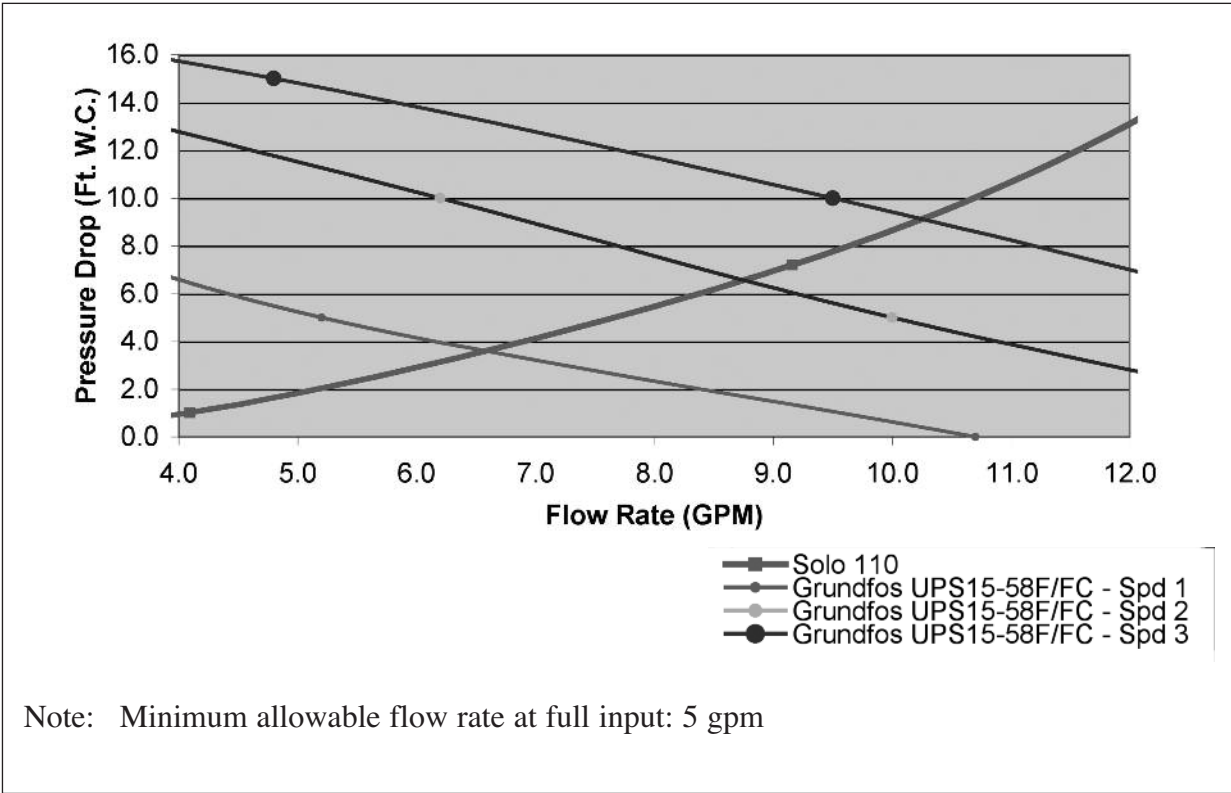

---

## Notes

---



---

## Notes

---



---

## Notes

---



---

## Notes

---



## Additional quality water heating equipment available from ACV-Triangle Tube

### Maxi-Flo and Spa Heat Exchangers



- Construction of high quality corrosion resistant stainless steel (AISI 316) or titanium
- Specially designed built-in flow restrictor to assure maximum heat exchange
- Compact and light weight
- Available in 8 sizes that can accommodate any size pool or spa

### SMART Indirect Fired Water Heaters



- Exclusive Tank-in-Tank design
- Stainless steel construction
- Available in 7 sizes
- Limited LIFETIME residential warranty
- 6 year limited commercial warranty
- Self cleaning/self descaling design

### TTP Brazed Plate Heat Exchangers

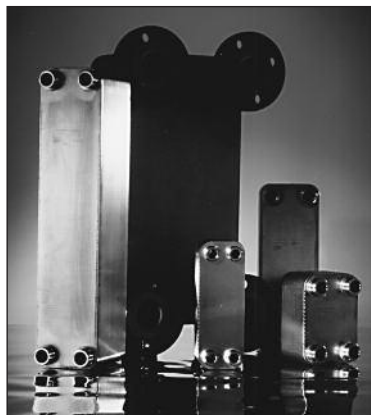

- For domestic water, snow melting, radiant floor, refrigeration
- Plates made of stainless steel, with a 99.9 % copper and brazed, ensuring a high resistance to corrosion
- Self cleaning and self descaling
- Computerized sizing available from ACV-Triangle Tube
- Available in capacities from 25,000 BTU/hr to 5,000,000 BTU/hr



Triangle Tube - 1 Triangle Lane - Blackwood, NJ 08012 - Tel: (856) 228 8881 - Fax: (856) 228 3584  
<http://www.triangle tube.com> - E-mail: [Info@triangle tube.com](mailto:Info@triangle tube.com)