

Connector 1, Battery Selector to Deck Harness Male with Pins		
1	2	3
Or/Bk 16 Cockpit Refrigerator	Pk/Rd 14 Stereo Memory	Or/Bk 10 Mascerator Brkr Power
4		
Bn/Bk 10 Mascerator	5	6
Switched Pwr		

Connector 2, Isolator Harness to Battery Selector Panel Male with Pins		
1	2	3
Rd/Gn 14 Cabin Refrig Power	Bn/Or 10 Aft Bilge Auto/Switch Pwr	Pk/Wt 16 High Water Alarm Power
4	5	6
Or/Bn 10 Fwd Bilge Auto/Switch Pwr	Rd/Yl 14 Vac Flush Brkr Pwr	Bk 10 Hatch Override, Up
7	8	9
Gn 10 Hatch Override, DN	Bn/Bk 10 Mascerator Power	Pk/Or 16 CO Detector

Connector 3, Isolator Harness to DSR Panel Male with Pins		
1	2	3
Yl/Rd 16 Gen Start/Stop Signal	Gy/Bk 16 Gen Start/Stop Comm	Pu/Yl 16 Gen 'ON' Lt Power
4	5	6
Bk/Wt 16 Gen 'ON' Lt Ground	Or/Yl 10 Blower Breaker Pwr	Yl 12 Blower Power
7	8	9
Bk 16 Ground 1 (blower switch)		

Connector 4, Switch Panel to Breaker Panel Male with Pins		
1	2	3
Or/Gn 16 Nav/Anc Lts Brkr Pwr	Or/Wt 16 Cockpit Lts Brkr Pwr	Or/Bk 16 Transom Lt Brkr Pwr
4	5	6
Or/Gy 16 Step Light Brkr Pwr	Or/Lt Bu 16 Accd(Swim Lt)	Rd/Bk 12 Hatch Brkr Pwr
7	8	9
Or 16 Wiper Brkr Pwr(Park)	Or/Rd 16 Accd/Ckpt Wash) Pwr	Or/Gn 16 Galley Pump Brkr Pwr
10	11	12
Rd/Gn 16 GPS/Radar Brkr Pwr	Tn/Or 16 Hom Brkr Pwr	Or/Yl 12 Blower Brkr Pwr
13	14	15
Rd/Pu 14 Ignition Pwr (Hot)	Rd/Pu 14 Ignition Pwr (Protected)	Rd 14 12V DC Pwr

Connector 5, Switch Panel to Breaker Panel Male with Pins		
1	2	3
Rd 10 Aft TV Brkr Pwr	Rd/Pu 10 Salon TV Brkr Pwr	Bu/Rd 10 Cabin Light Brkr Pwr
4	5	6
Or 16 TV Pre-Amp Brkr Pwr	Bu/Bn 16 Head Lights Brkr Pwr	Or/Rd 12 Cabin 12V DC Pwr
7	8	9
Bn/Gy 16 Shower Sump Brkr Pwr	Rd/Yl 12 Trim Tabs Brkr Pwr	Rd/Bk 16 VHF Brkr Pwr
10		
Rd/Or 16 Spot Light Brkr Pwr	11	12

Connector 6, Switch Panel to Ignition Panel Male with Pins		
1	2	3
Yl 12 Blower Sw. Pwr	Or/Yl 12 Blower Brkr Pwr	Rd 14 12V DC Pwr
4	5	6
Bu 16 Panel Lts	Bk 16 Ground	Or/Gn 16 Stereo "On"
7	8	9
Rd/Pu 16 Ign Power	Bk/Yl 16 Fireboy	

Connector 7, Gauge Panel to Switch Panel Male with Pins			
1	2	3	4
Rd/Pu 16 Ignition Pwr	Pk 16 Fuel Signal	Bu 16 Panel Lights	Bk 16 Ground

Connector 8, Switch Panel to Gauge Panel Male with Pins		
1	2	3
Pu 16 Ignition	Yl/Rd 16 Engine Crank	Tn/Bu 16 Warning Signal

Connector 5, Switch Panel to Breaker Panel Male with Pins		
1	2	3
Rd 10 Aft TV Brkr Pwr	Rd/Pu 10 Salon TV Brkr Pwr	Bu/Rd 10 Cabin Light Brkr Pwr
4	5	6
Or 16 TV Pre-Amp Brkr Pwr	Bu/Bn 16 Head Lights Brkr Pwr	Or/Rd 12 Cabin 12V DC Pwr
7	8	9
Bn/Gy 16 Shower Sump Brkr Pwr	Rd/Yl 12 Trim Tabs Brkr Pwr	Rd/Bk 16 VHF Brkr Pwr
10		
Rd/Or 16 Spot Light Brkr Pwr	11	12

Connector 6, Switch Panel to Ignition Panel Male with Pins		
1	2	3
Yl 12 Blower Sw. Pwr	Or/Yl 12 Blower Brkr Pwr	Rd 14 12V DC Pwr
4	5	6
Bu 16 Panel Lts	Bk 16 Ground	Or/Gn 16 Stereo "On"
7	8	9
Rd/Pu 16 Ign Power	Bk/Yl 16 Fireboy	

Rinker
Time Well Spent
300 V Chicago St. - Syracuse, IN 46567

Title	Connector Descrip 1-8	Sheet	1 of 1
Drawing Number	280-2007-SDCD01	Size	A

Connector 9, Engine Harness to Dash Harness Male with Pins		
1	2	3
Rd/Pu 14 Ignition Bkr Power	Pu 16 Ignition	Lt B1 16 Oil Pressure Signal
4	5	6
W/Pu 16 Trim Signal	Tn/B1 16 Audio Warning	Gy 16 Tach Signal
7	8	9
Yl/Rd 16 Crank	Tn 16 Temperature Signal	

Connector 10, Isolator Harness to Dash Harness Male with Pins		
1	2	3
Or/Rd 12 Cabin 12V Outlet Power	Bn/Gn 14 Fresh Water Pump Power	Pk 16 Fuel Level Signal
4	5	6
Bn/Or 10 Aft Bilge Auto/Bkr Pwr	Bn 10 Aft Bilge Pump Manual Pwr	Or/Y1 10 Blower Bkr Power
7	8	9
Y1 12 Blower Power	B1 10 Engine Hatch Up Power	Gn 10 Engine Hatch DN Power
10	11	12
B1/Lt B1 16 Swim Light	Bk/Y1 16 Fireboy Light Ground	Or/Bn 10 Fwd Bilge Auto/Bkr Pwr
13	14	15
Bn/Rd 10 Fwd Bilge Manual Pwr	Bn/Gy 16 Shower Sump Power	Rd/Bn 14 Cockpit Wash Pump

Connector 11, Isolator Hrms to Dash Hrm Male with Pins	
1	2
B1/Gy 16 Sleep Light Power	

Connector 12, Deck Harness to Dash Harness Male with Pins		
1	2	3
Gy/Gn 14 Nav Lis Power	Rd 10 Aft Cabin TV Power	Bk 10 Ground 3
4	5	6
Bk 10 Ground 4		

Connector 13, Deck Harness to Dash Harness Male with Pins		
1	2	3
Or/Gn 16 Stereo 'ON' Signal	Lt B1/Wt 16 Remote Illumination	Gy/B1 16 Anchor Lt Power
4	5	6
Gy/Bk 16 Transom Lt Power	B1/Wt 16 Cockpit Lt Power	Or/B1 10 Cabin Lights Power
7	8	9
Tn/Wt 14 Horn Power	Or 14 Wiper Park	Or/Wt 14 Wiper Switched Pwr
10	11	12
Rd/Pu 10 Salon TV Power	Or 16 TV Pre-Amp Power	B1/Bn 16 Head Lis Power

Connector 14, Deck Harness to Stereo Harness Male with Pins		
1	2	3
Pk/Rd 14 Stereo Memory	Or/Gn 16 Stereo 'ON' Signal	Bk 10 Stereo Ground
4	5	6
Gy 16 Cabin Sbd Speaker	Gy/Bk 16 Cabin Sbd Speaker	Pu 16 Cockpit Fwd Sbd Spkr
7	8	9
Pu/Bk 16 Cockpit Fwd Sbd Spkr	Bn 16 Cockpit Aft Sbd Spkr	Bn/Bk 16 Cockpit Aft Sbd Spkr
10	11	12
Wt 16 Cabin Port Speaker	Wt/Bk 16 Cabin Port Speaker	Gn 16 Cockpit Fwd Port Spkr
13	14	15
Gn/Bk 16 Cockpit Fwd Port Spkr	Or 16 Cockpit Aft Port Spkr	Or/Bk 16 Cockpit Aft Port Spkr

Connector 15, Deck Hrm to Stereo Hrms Male with Pins	
1	2
Lt B1/Wt 16 Remote Illumination	

Rinker
Time Well Spent
300 W Chicago St. - Syracuse, IN 46567

Title Connector Sescrip 9-15
Drawing Number 280-2007-SDCD02
Sheet 1 of 1
Size A



Surface Mount
Outlet

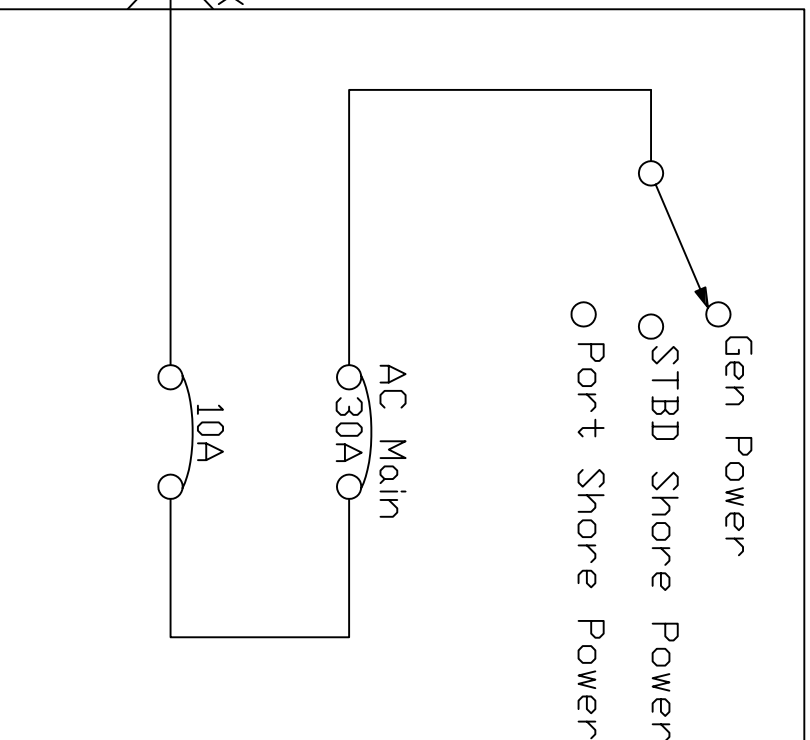
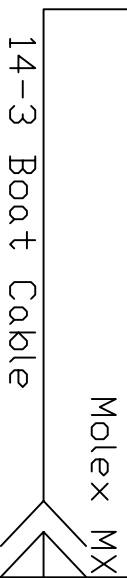

Rinker

300 W Chicago St. - Syracuse, IN 46567
Time Well Spent

Title	Cabin Refrigerator			Sheet	1	of	1
Drawing Number	280-2007-SDAC01			Size	A		
Date	11-04	Sheet	1	of	1		

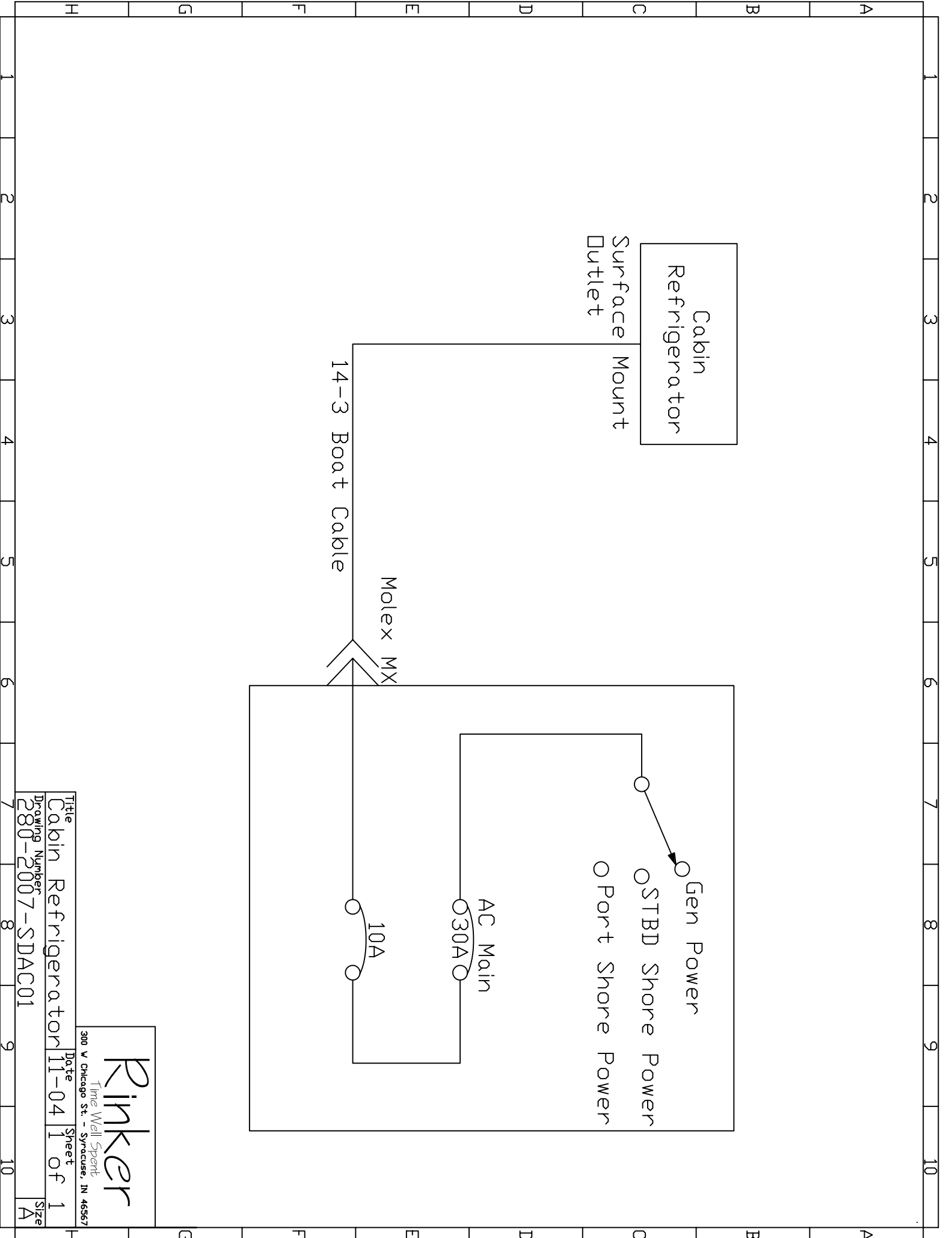

Cockpit
Refrigerator
Ice Maker

Surface Mount
Outlet

14-3 Boat Cable
Molex MX

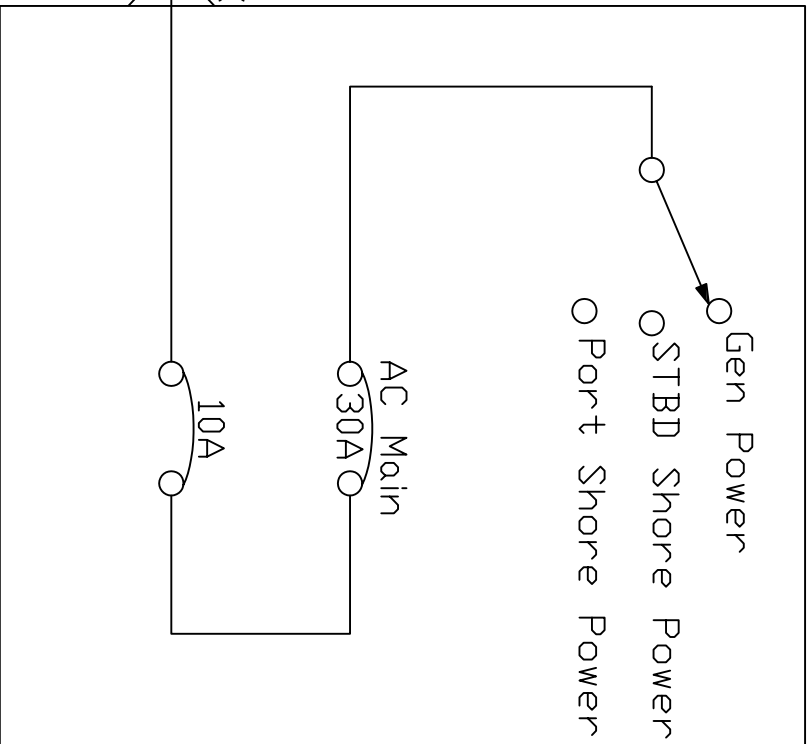

Rinker

Time Well Spent
300 W Chicago St. - Syracuse, IN 46567

Title
Ckpt Refrigerator/Ice Maker
Drawing Number
280-2007-SDAC02

Size
A

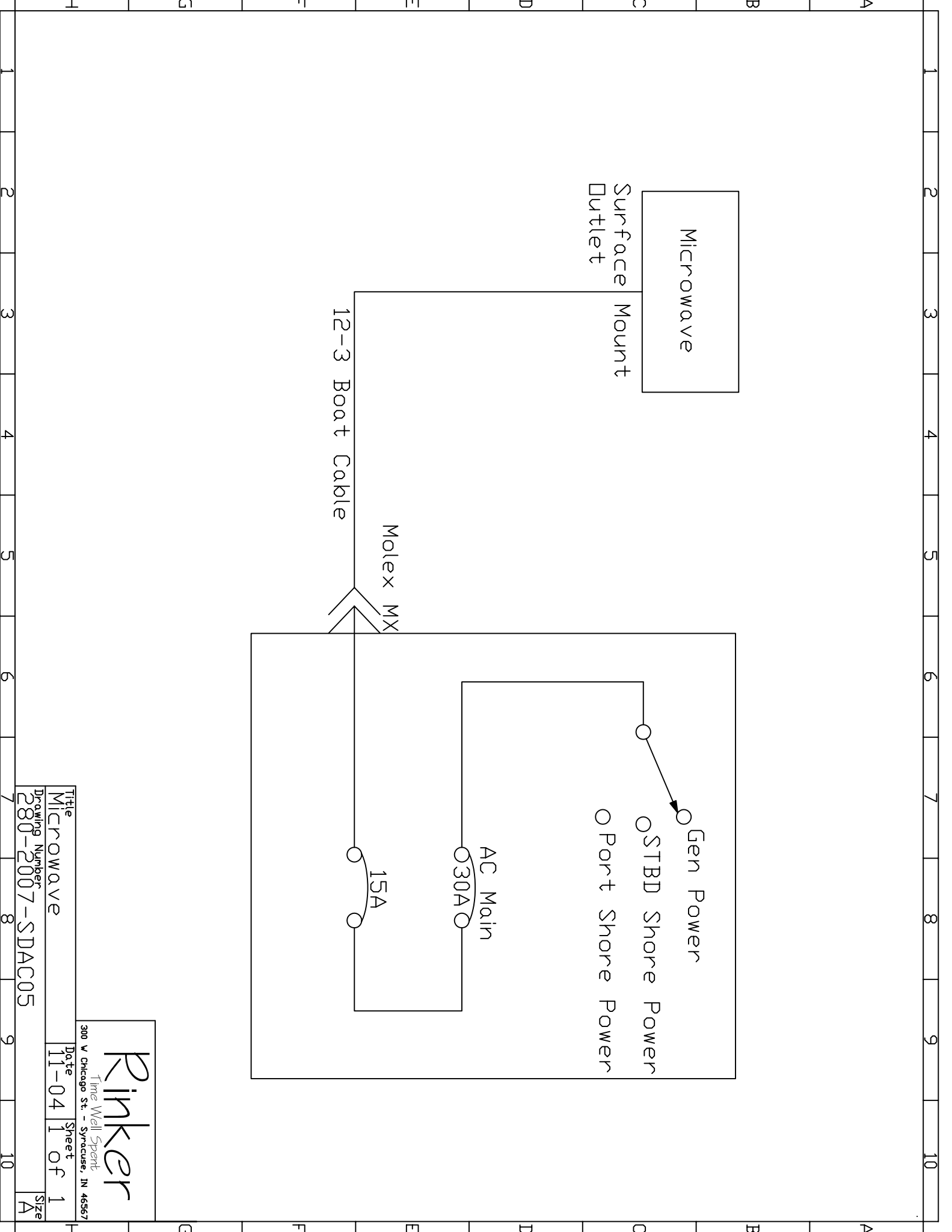

Title
Microwave
Drawing Number
280-2007-SDAC05

Rinker
 300 V Chicago St. - Syracuse, IN 46567
 Time Well Spent
 Date 11-04 Sheet 1 of 1
 Size A

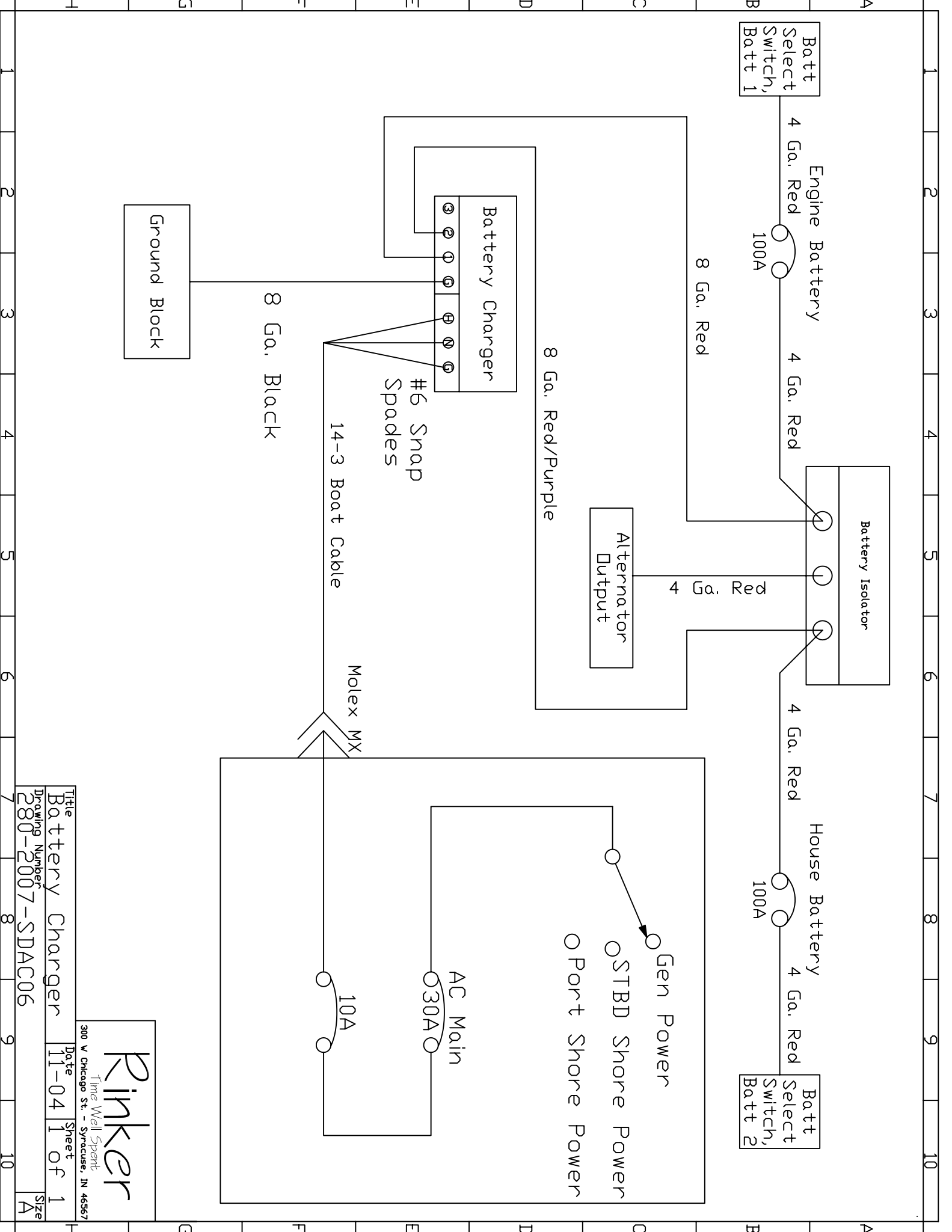

Title
Battery Charger
Drawing Number
280-2007-SDAC06

Date
11-04
Sheet
1 of 1

Rinker
Time Well Spent
300 V Chicago St. - Syracuse, IN 46567

Size
A

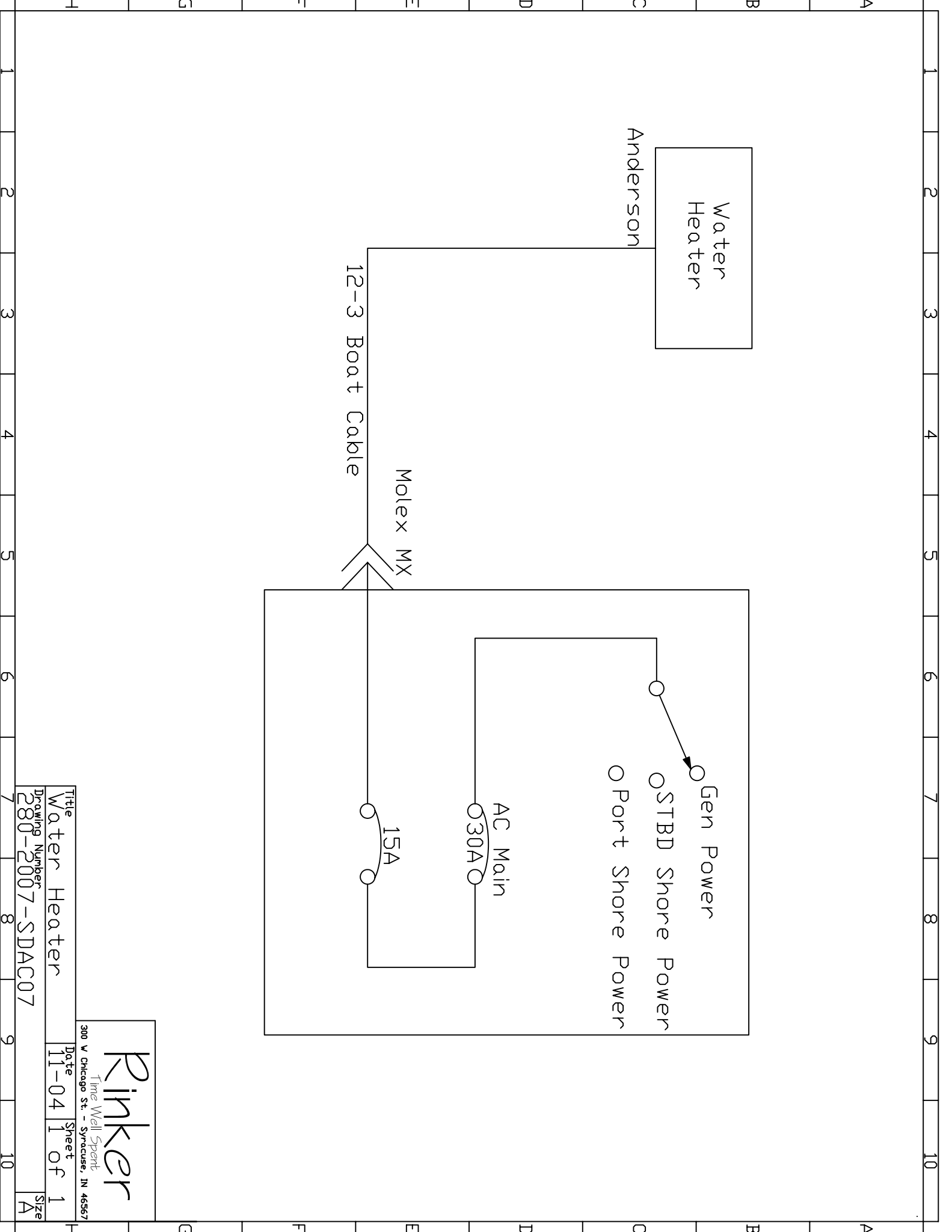

<h1 style="text-align: center;">Rinker</h1> <p style="text-align: center; font-size: small;">300 V Chicago St. - Syracuse, IN 46567 Time Well Spent.</p>		Title	Date	Sheet	Size
		Water Heater	11-04	1 of 1	
<p style="font-size: small;">Drawing Number</p> <p style="font-size: x-large; font-weight: bold;">280-2007-SDAC07</p>					

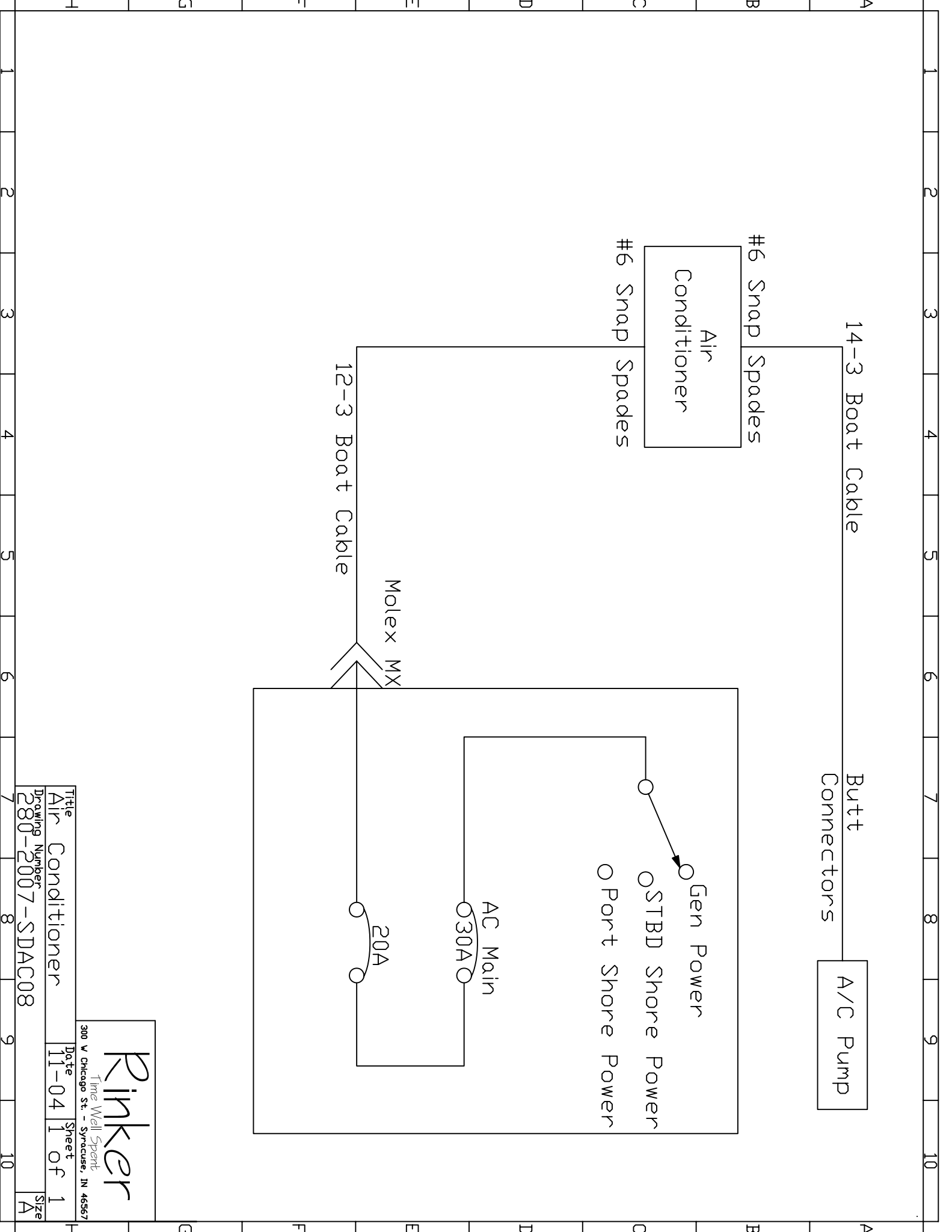

Title	Air Conditioner		
Drawing Number	280-2007-SDAC08		
Date	11-04	Sheet	1 of 1
Size	A		

Rinker
 Time Well Spent
 300 W Chicago St. - Syracuse, IN 46567

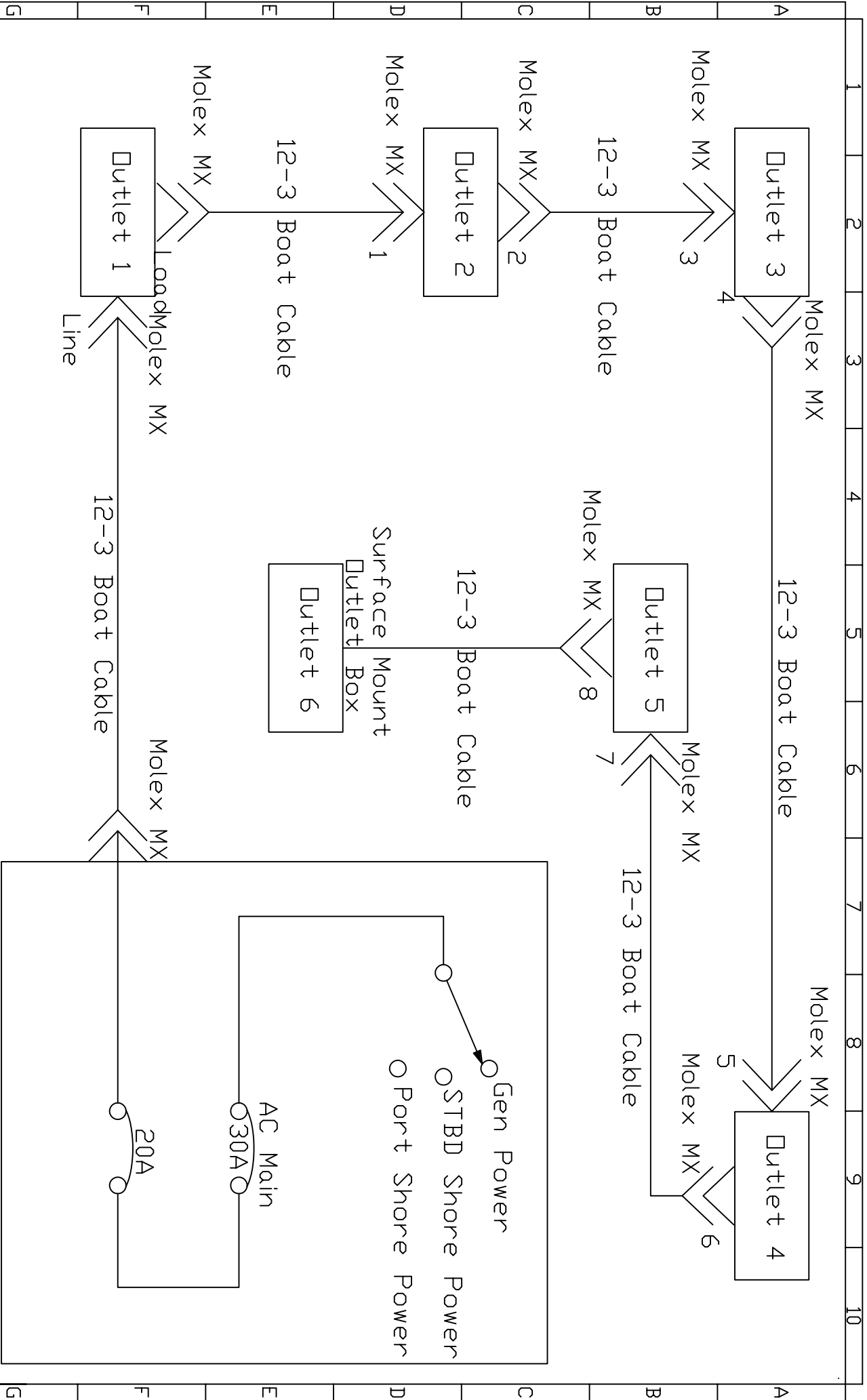

<h1>Rinker</h1> <p>Time Well Spent. 300 W Chicago St. - Syracuse, IN 46567</p>	
Title Outlets	Date 11-04
Drawing Number 280-2007-SDAC09	Sheet 1 of 1
Size A	

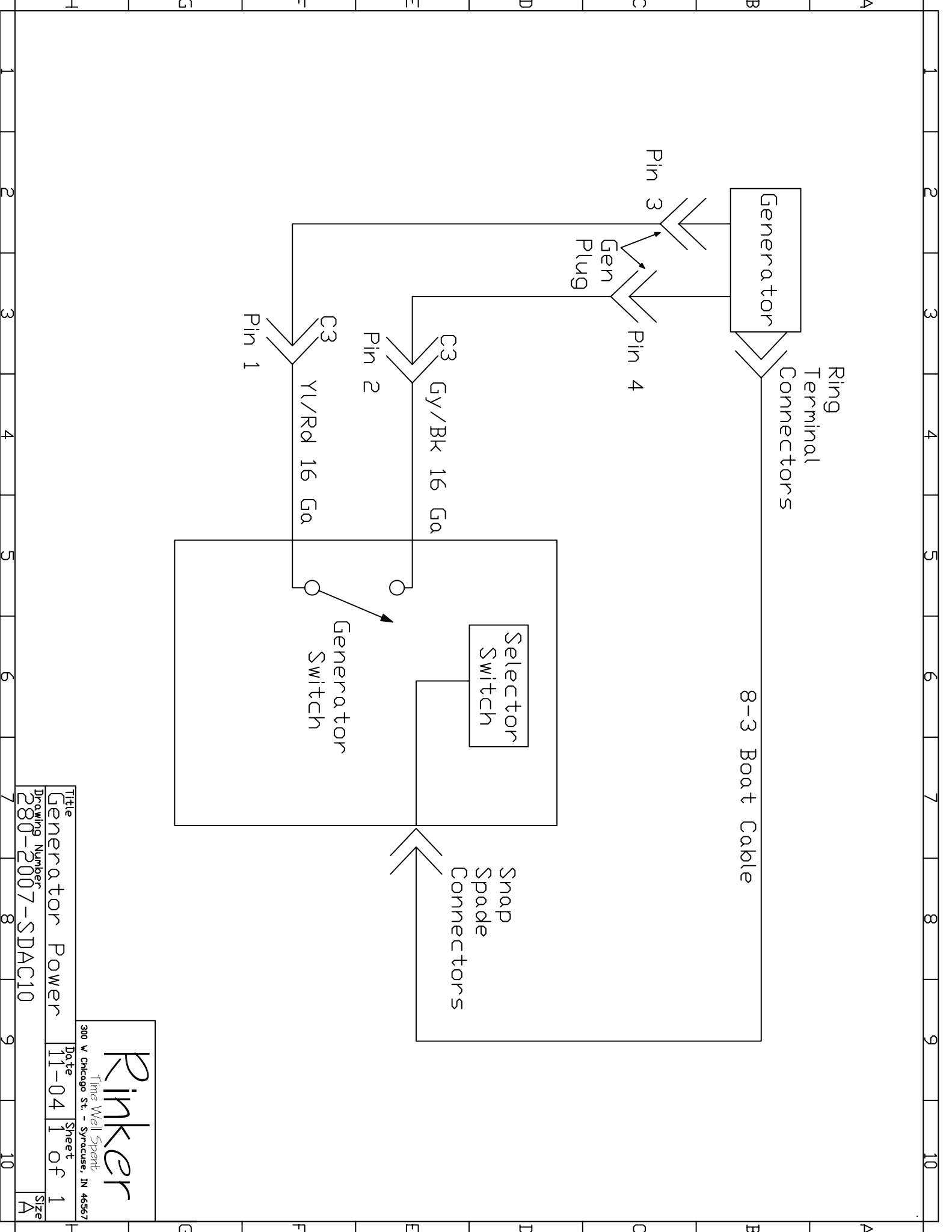

Title
 Generator Power
 Drawing Number
 280-2007-SDAC10

Date
 11-04
 Sheet
 1 of 1

Rinker
 Time Well Spent
 300 V Chicago St. - Syracuse, IN 46567

Size
 A

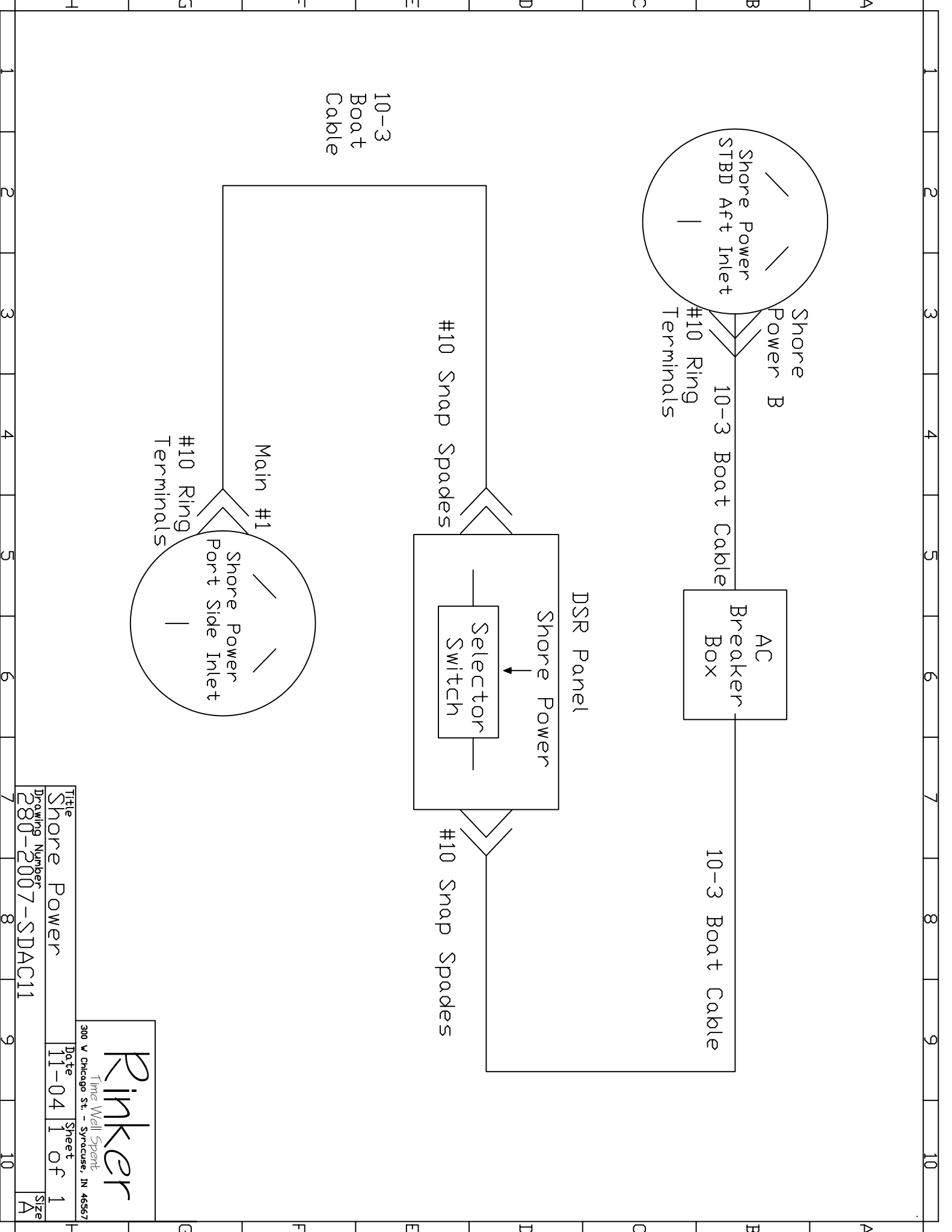

10-3
Boat
Cable

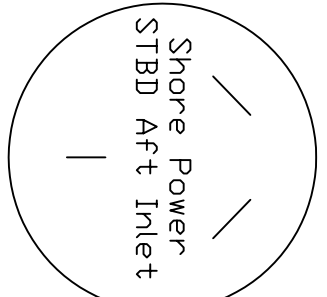

Shore Power B
#10 Ring Terminals

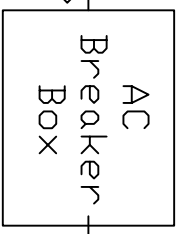

AC Breaker Box

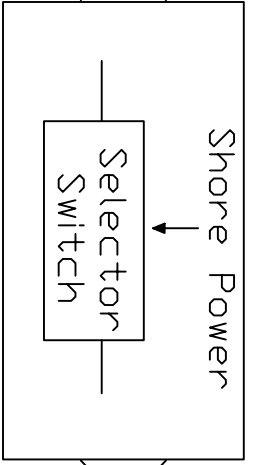

DSR Panel

#10 Snap Spades

#10 Snap Spades

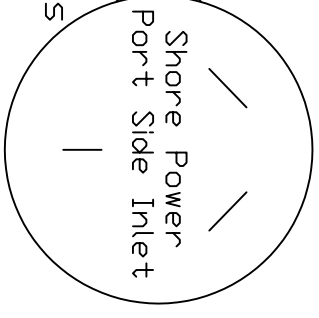

Main #1
#10 Ring Terminals

Shore Power Port Side Inlet

Title	Shore Power		
Drawing Number	280-2007-SDAC11		

Rinker
Time Well Spent
300 V Chicago St. - Syracuse, IN 46567

Date	11-04	Sheet	1 of 1
Size	A		

Batt
Select
Switch,
House
Switched

Rd 14 Ga



Rd/Pu 14 Ga

Ca thode

Rinker

Time Well Spent
300 V Chicago St. - Syracuse, IN 46567

Date 11-04 Sheet 1 of 1

Title
Ca thode
Drawing Number
280-2007-SD01

Size
A

Batt
Select
Switch,
House
Switched

Rd 8 Ga

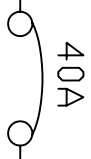

Rd 8 Ga

Amplifier

Ground
Block

Bk 8 Ga

Rinker

Time Well Spent
300 V Chicago St. - Syracuse, IN 46567

Date 11-04 Sheet 1 of 1

Title Amplifier
Drawing Number 280-2007-SD02

Size A

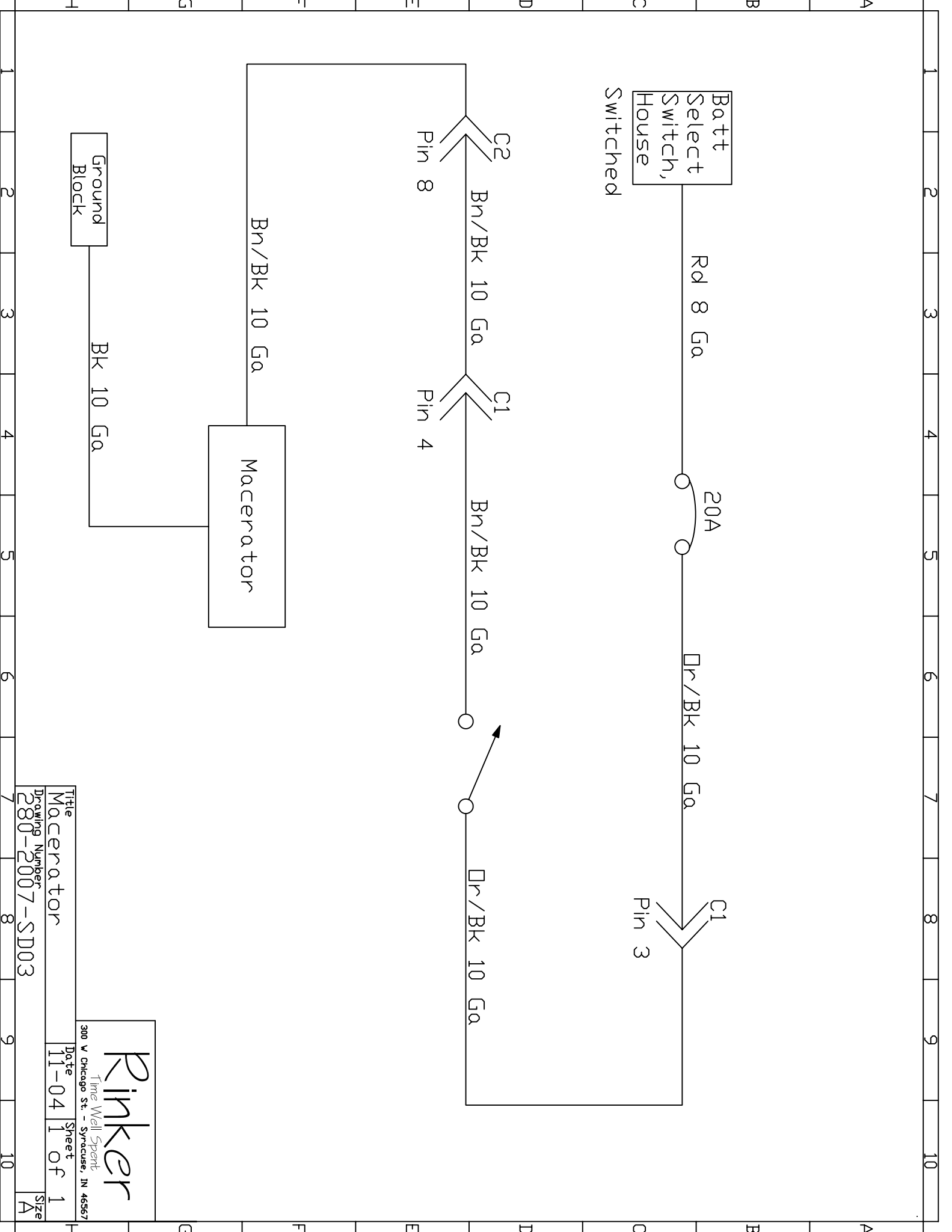

Batt
Select
Switch,
House
Switched

Rd 8 Ga

20A

Dr/Bk 10 Ga

C1
Pin 3

C2
Pin 8

Bn/Bk 10 Ga

C1
Pin 4

Bn/Bk 10 Ga

O

O

Dr/Bk 10 Ga

Bn/Bk 10 Ga

Macerator

Ground
Block

BK 10 Ga

Rinker
Time Well Spent
300 V Chicago St. - Syracuse, IN 46567

Title
Macerator

Drawing Number
280-2007-SD03

Date
11-04

Sheet
1 of 1

Size
A

Batt
Select
Switch,
House

Switched

Rd 14 Ga



PK/Dr 16 Ga

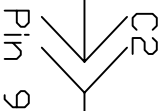

PK/Dr 16 Ga

Ground
Block

Bk 16 Ga

CD Detector

PK/Dr 16 Ga

Rinker

Time Well Spent
300 V Chicago St. - Syracuse, IN 46567

Date 11-04 Sheet 1 of 1

Title CD Detector
Drawing Number 280-2007-SD04

Size A

Batt
Select
Switch,
House

Switched

Rd 14 Ga



Rinker

300 V Chicago St. - Syracuse, IN 46567
Time Well Spent

Title	Acc Battery Panel	Date	11-04	Sheet	1 of 1	Size	A
Drawing Number	280-2007-SD05						

Batt
Select
Switch,
House

Switched

Rd 14 Ga



Rd/Gn 14 Ga

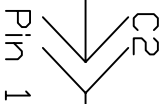

Rd/Gn 14 Ga

Bk 14 Ga

Cabin
Refrigerator

Rd/Gn 14 Ga

Bk 14 Ga

Ground
Block

Rinker

300 V Chicago St. - Syracuse, IN 46567
Time Well Spent

Title	Cabin Refrigerator	Date	11-04	Sheet	1 of 1	Size	A	
Drawing Number	280-2007-SD06							

Batt
Select
Switch,
House
Switched

Rd 14 Ga



Dr/Bu 16 Ga

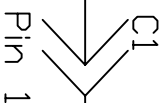

Dr/Bu 16 Ga

Bk 16 Ga

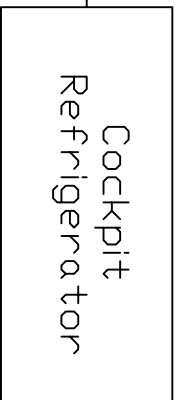

Dr/Bu 16 Ga

Bk 16 Ga



Rinker
Time Well Spent
300 W Chicago St. - Syracuse, IN 46567

Title	Cockpit Refrigerator	Sheet	1 of 1
Drawing Number	280-2007-SD07	Size	A

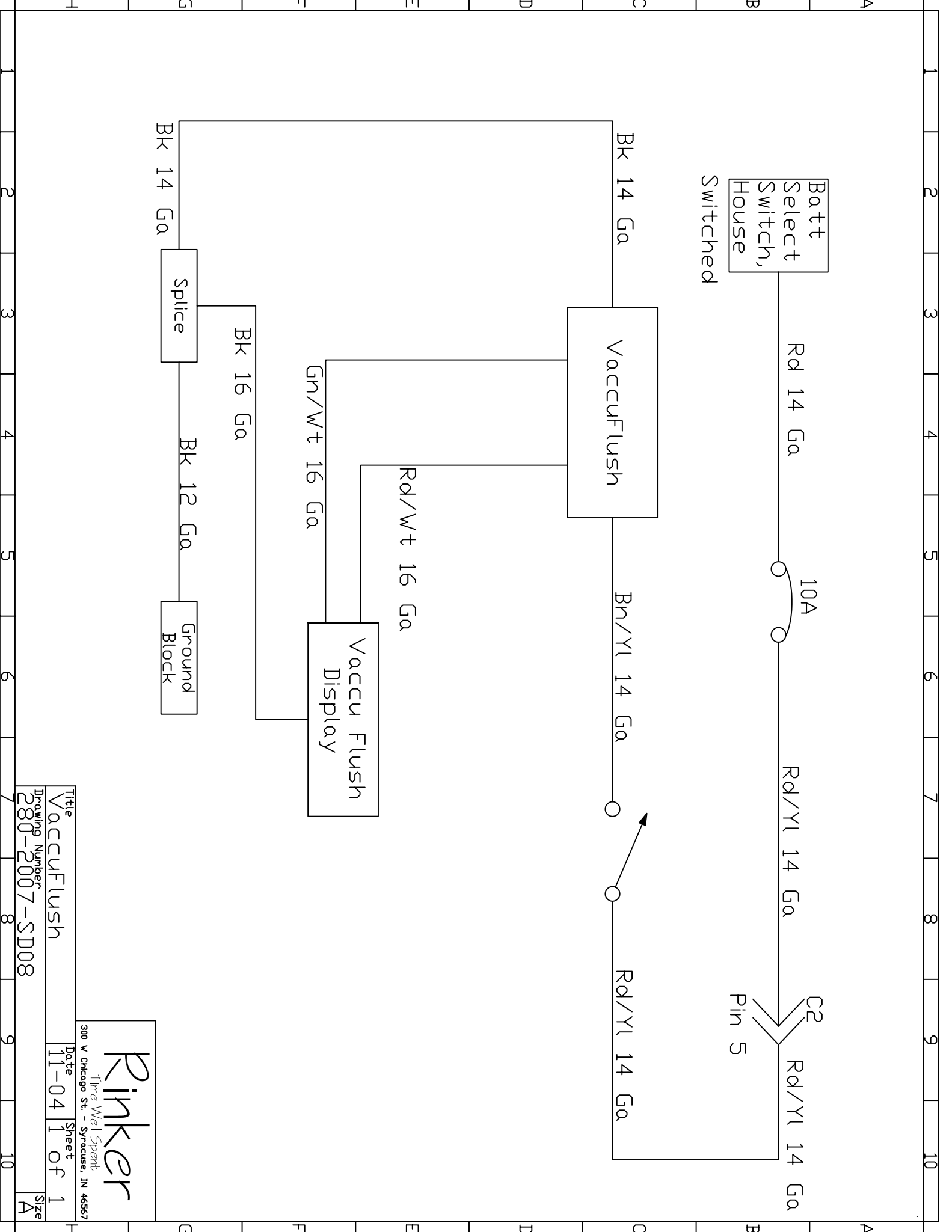

Title		VaccuFlush	
Drawing Number		280-2007-SD08	
Date	11-04	Sheet	1 of 1
Rinker Time Well Spent 300 W Chicago St. - Syracuse, IN 46567			

H
G
F
E
D
C
B
A

H
G
F
E
D
C
B
A

1 2 3 4 5 6 7 8 9 10

1 2 3 4 5 6 7 8 9 10

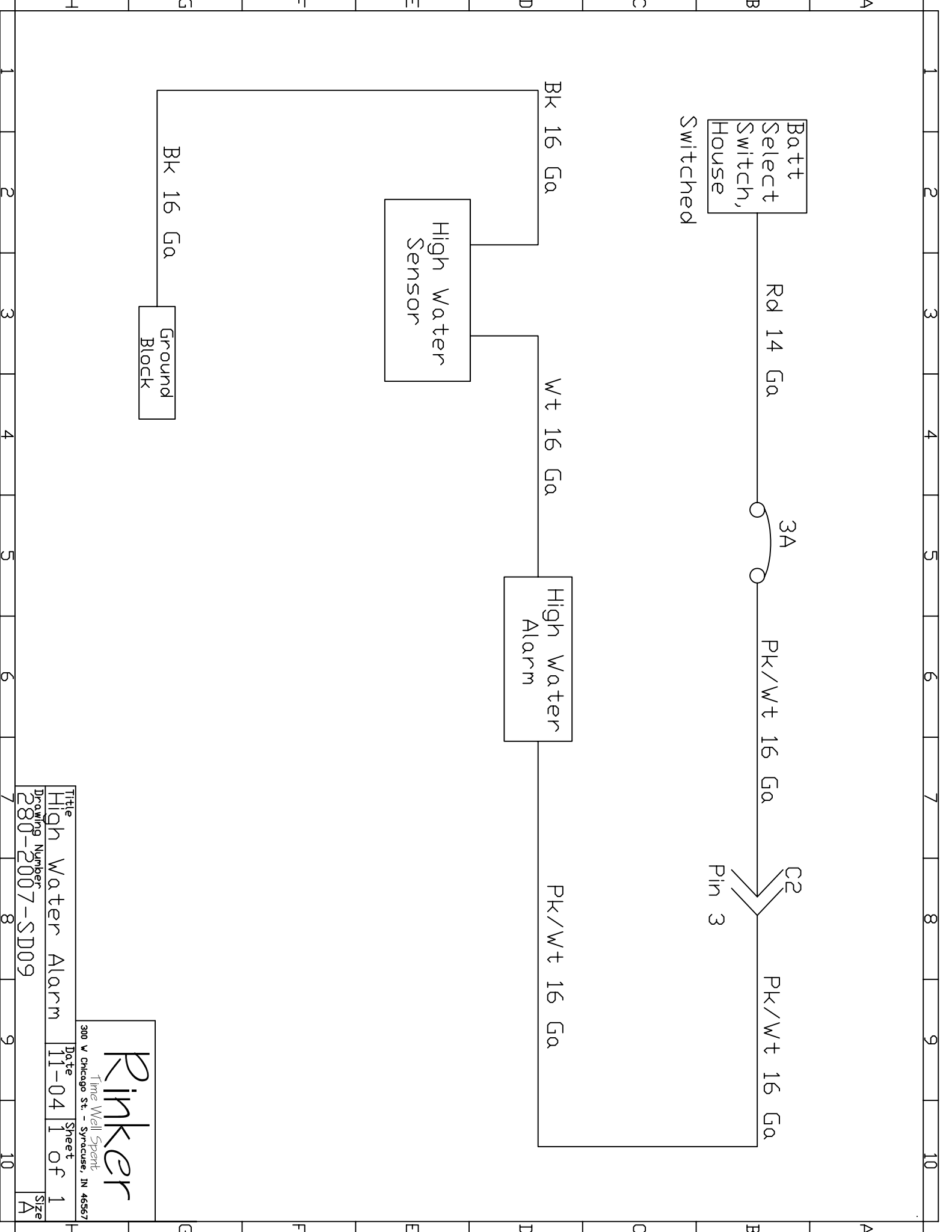

Batt
Select
Switch,
House

Switched

Rd 14 Ga

3A

PK/Wt 16 Ga

C2
Pin 3

PK/Wt 16 Ga

Bk 16 Ga

Wt 16 Ga

PK/Wt 16 Ga

High Water
Sensor

High Water
Alarm

Ground
Block

Bk 16 Ga

Rinker
Time Well Spent
300 V Chicago St. - Syracuse, IN 46567

Title	High Water Alarm	Date	11-04	Sheet	1 of 1	Size	A
Drawing Number	280-2007-SD09						

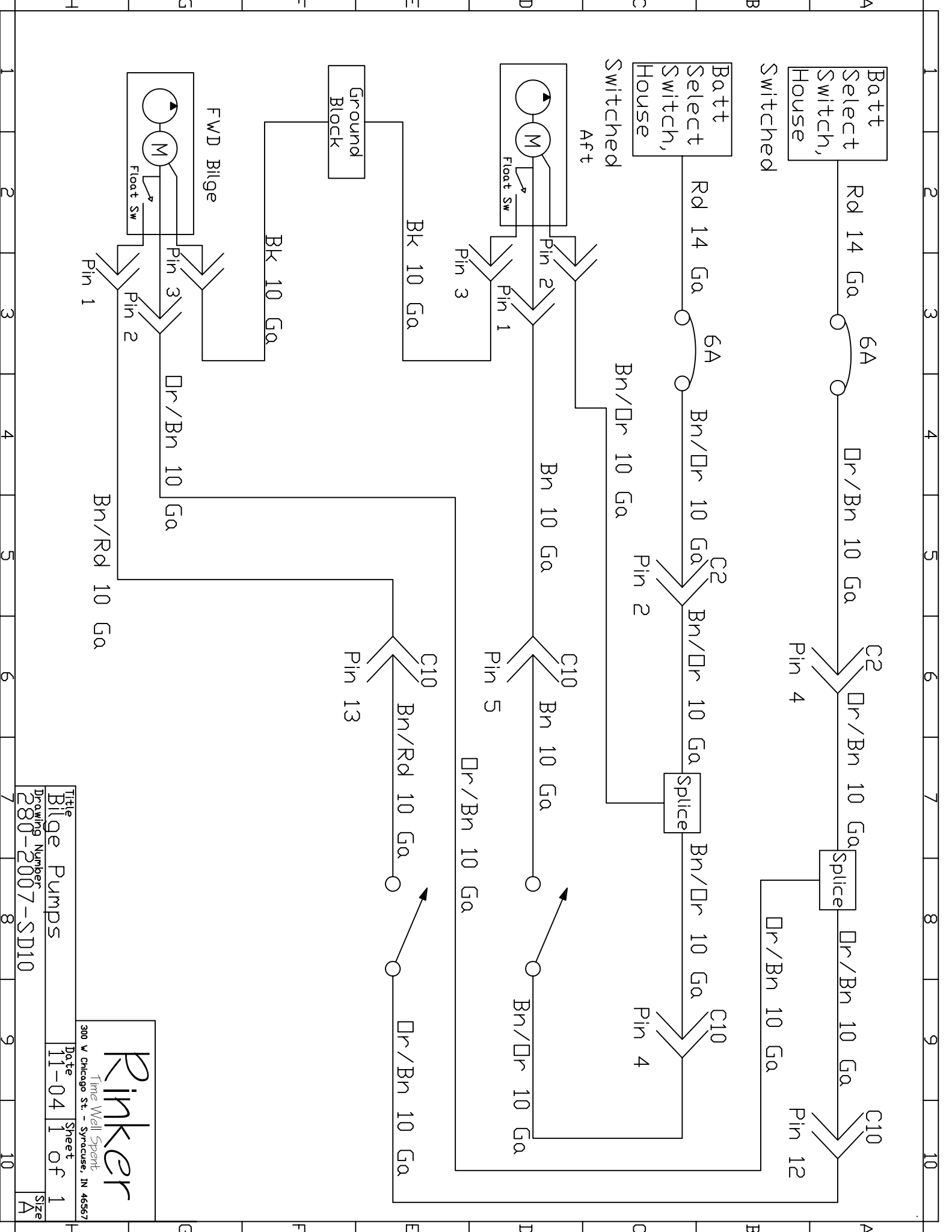

Title		Blige Pumps	
Drawing Number		280-2007-SD10	
Date	11-04	Sheet	1 of 1
300 V Chicago St. - Syracuse, IN 46567		Rinker Time Well Spent	
Size		A	

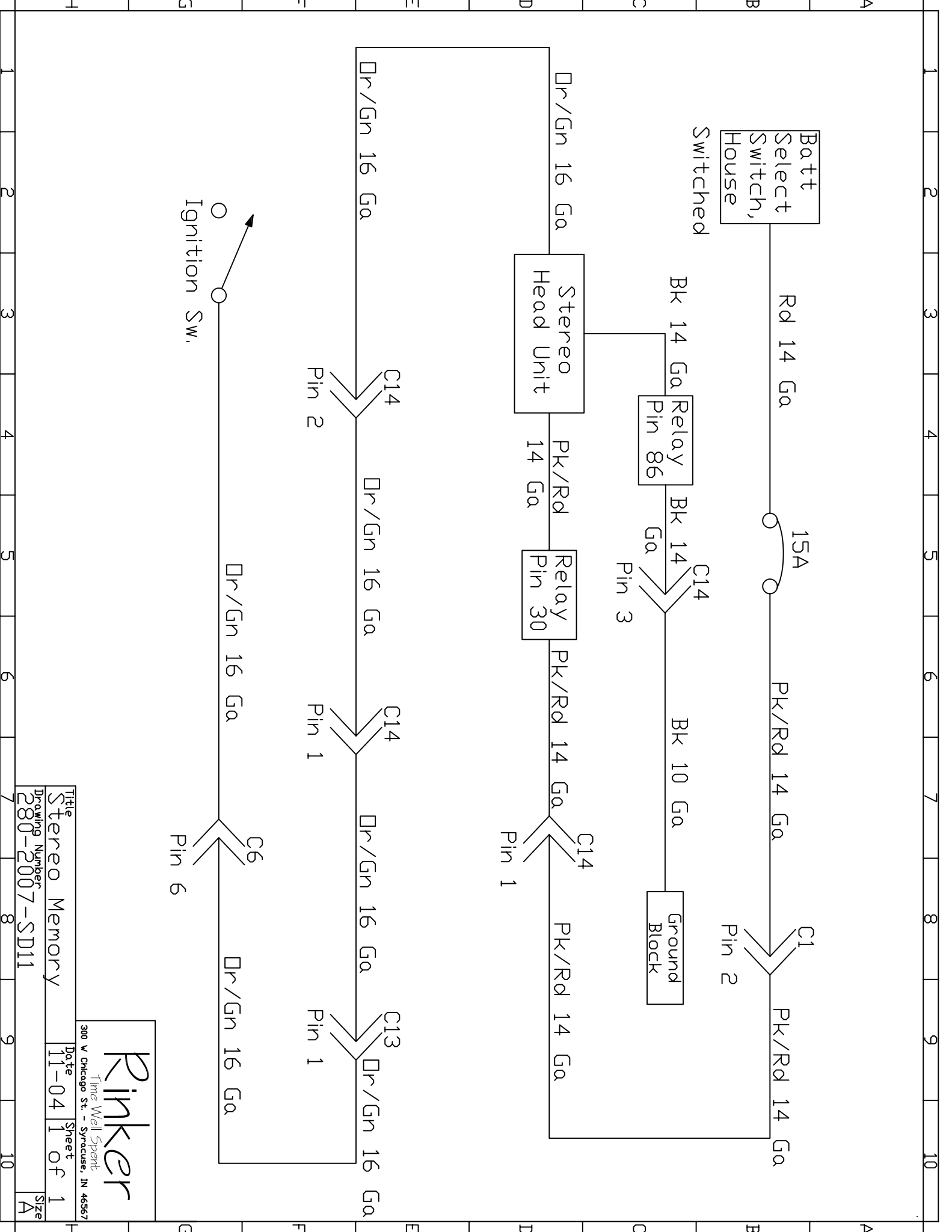

Title	Stereo Memory
Drawing Number	280-2007-SD11
Date	11-04
Sheet	1 of 1
Size	A

Rinker
 Time Well Spent
 300 W Chicago St. - Syracuse, IN 46567

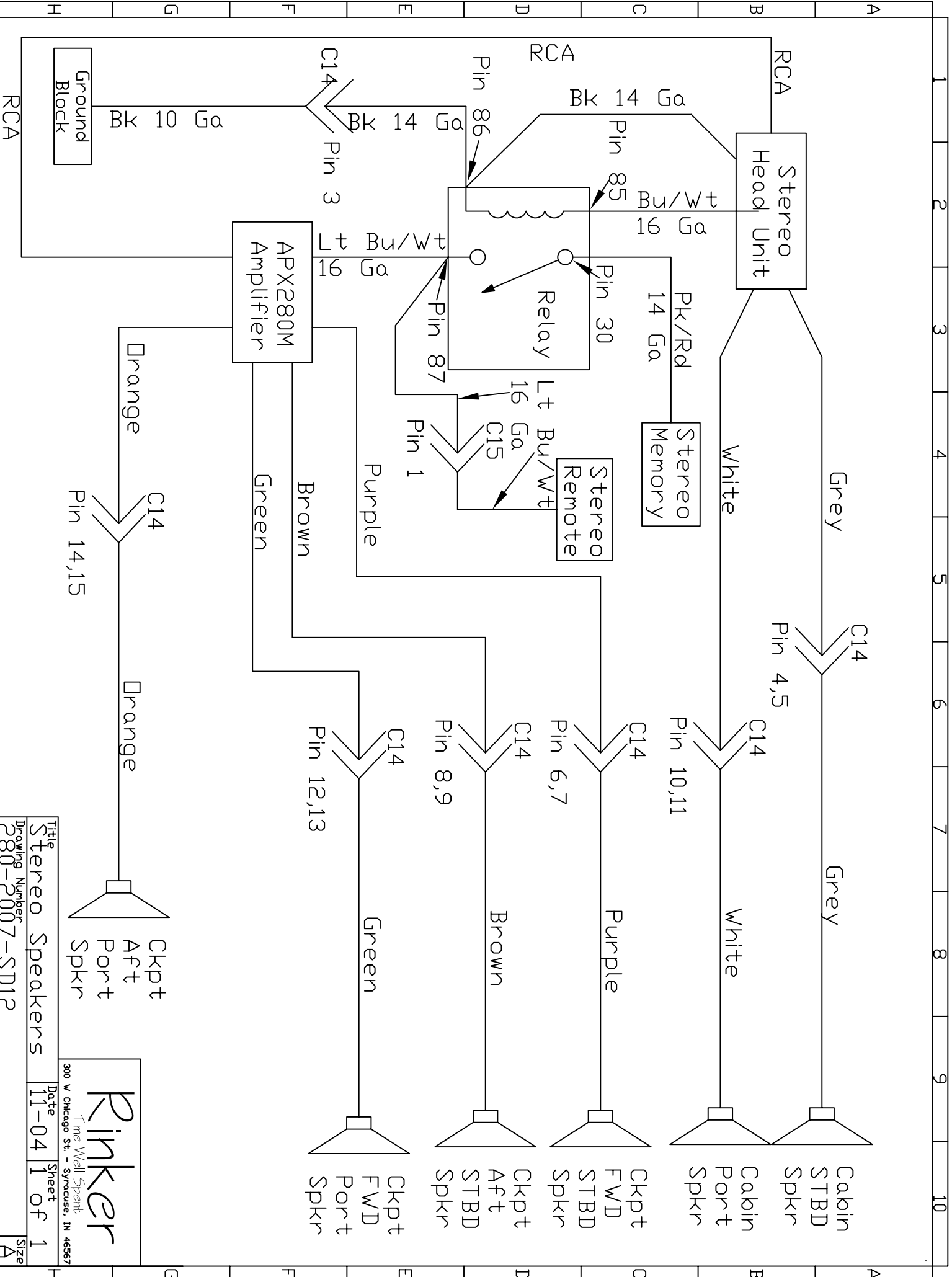

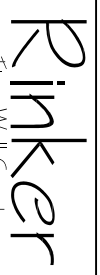
Title		Stereo Speakers	
Drawing Number		280-2007-SD12	
Date	11-04	Sheet	1 of 1
 <small>Time Well Spent.</small> <small>300 V Chicago St. - Syracuse, IN 46567</small>			

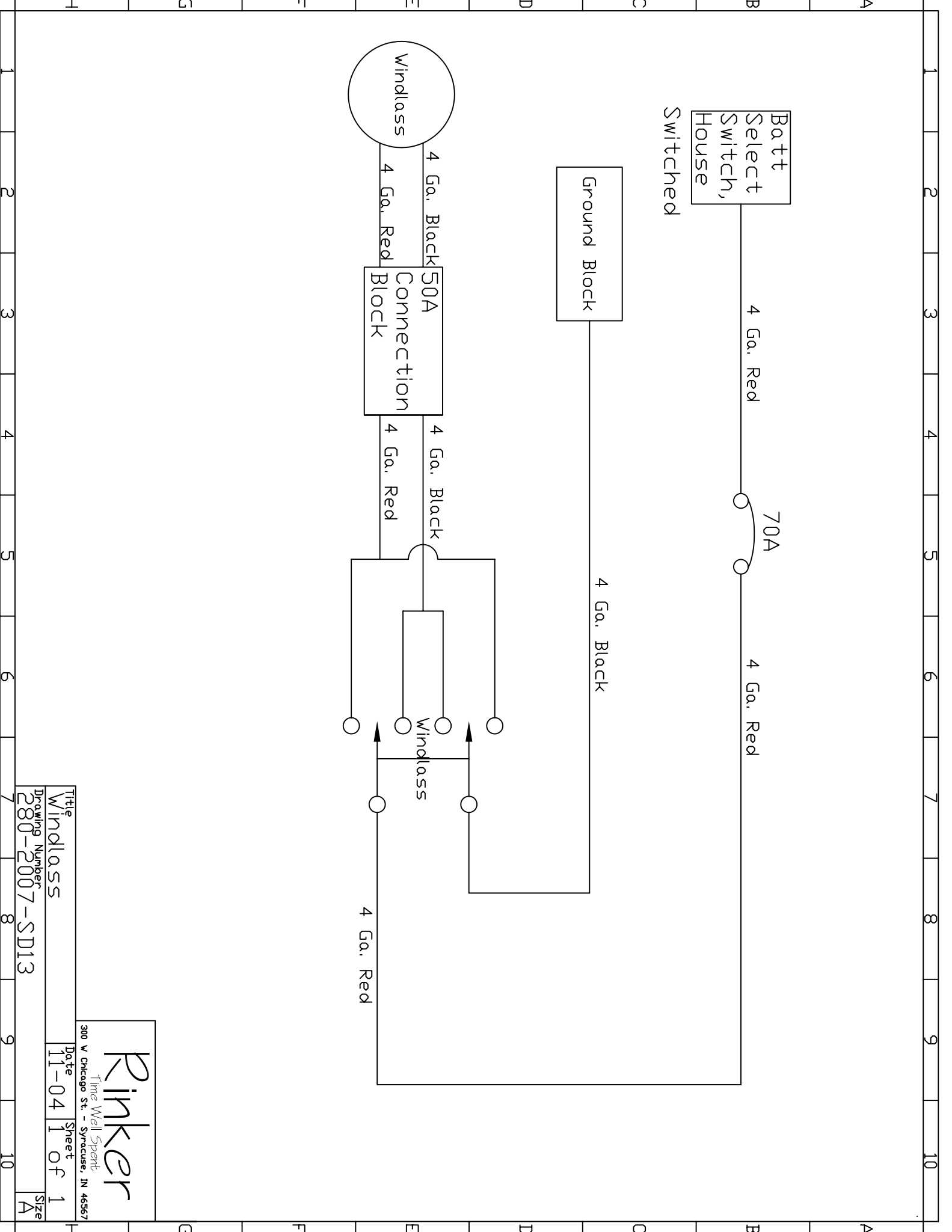

Batt
Select
Switch,
House
Switched

70A

Ground Block

50A
Connection
Block

Windlass

Windlass

Rinker
Time Well Spent
300 V Chicago St. - Syracuse, IN 46567

Title
Windlass

Drawing Number
280-2007-SD13

Date
11-04

Sheet
1 of 1

Size
A

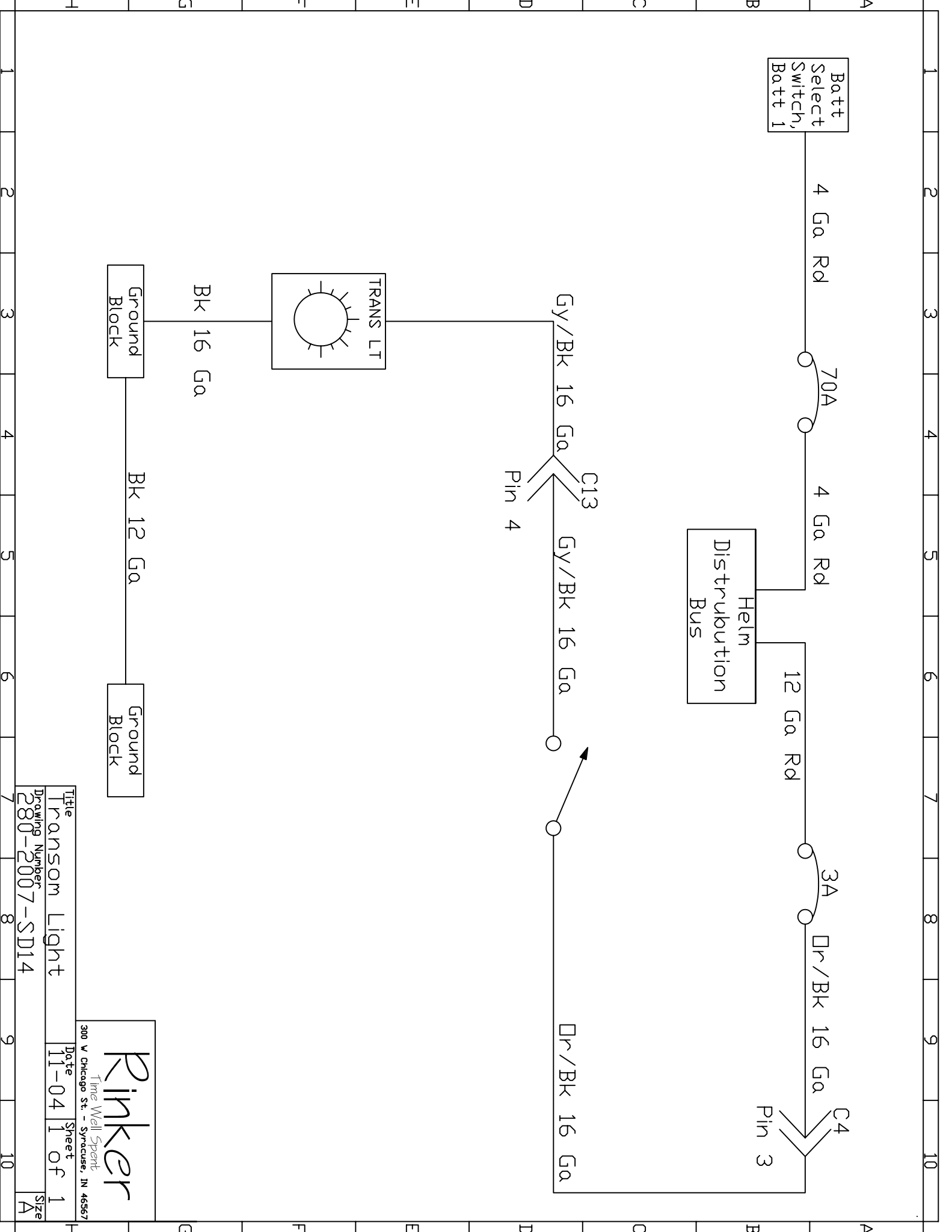

Battt
Select
Switch,
Battt 1

4 Ga Rd

70A

4 Ga Rd

Helm
Distribution
Bus

12 Ga Rd

3A

Dr/BK 16 Ga

C4
Pin 3

Gy/BK 16 Ga

C13
Pin 4

Gy/BK 16 Ga

○

○

Dr/BK 16 Ga

TRANS LT

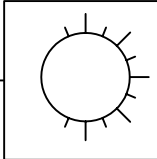

BK 16 Ga

Ground
Block

BK 12 Ga

Ground
Block

Rinker
Time Well Spent
300 V Chicago St. - Syracuse, IN 46567

Title	Transom Light	Date	11-04	Sheet	1	of	1	Size	A
Drawing Number	280-2007-SD14								

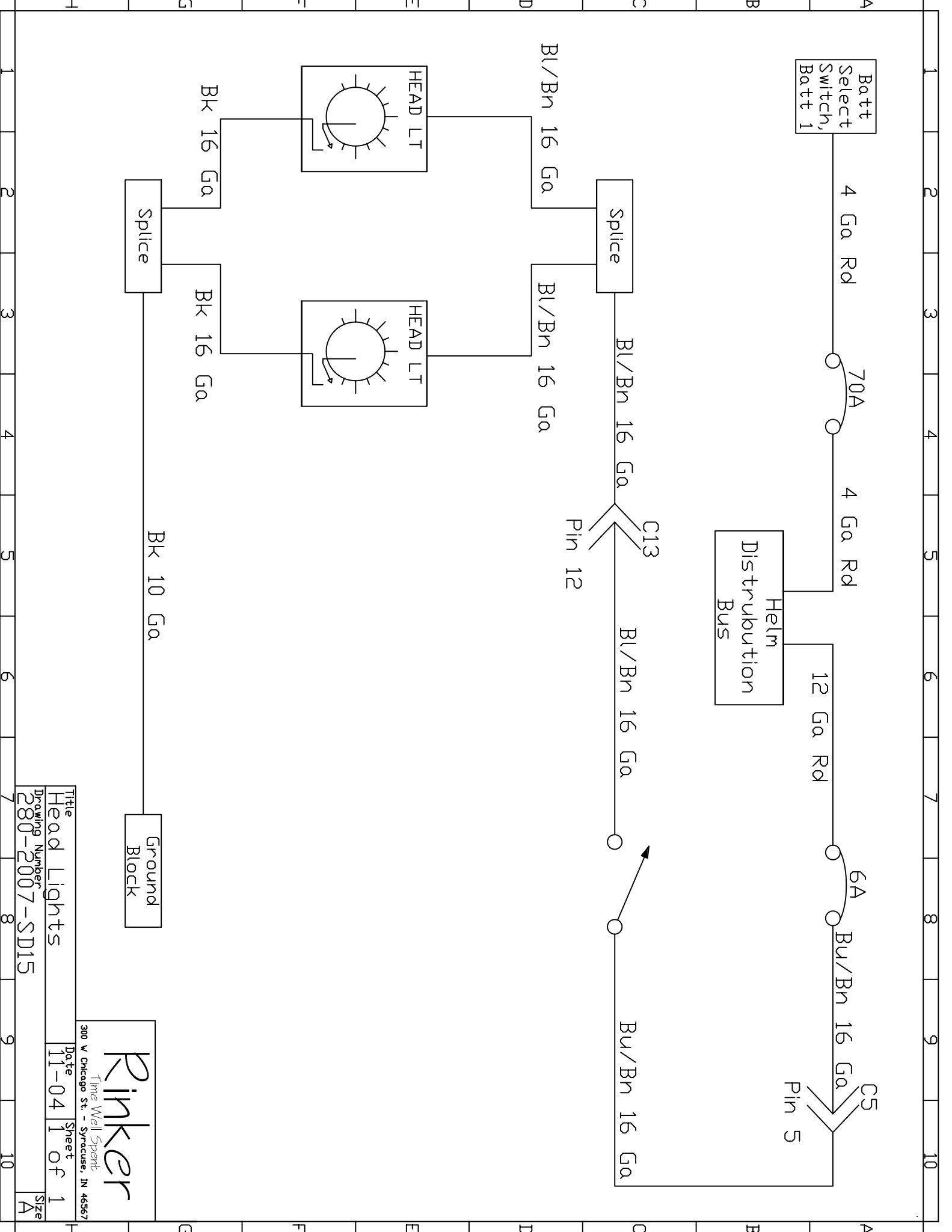

Title
Head Lights
Drawing Number
280-2007-SD15

Date
11-04
Sheet
1 of 1

Rinker
Time Well Spent
300 V Chicago St. - Syracuse, IN 46567

Size
A

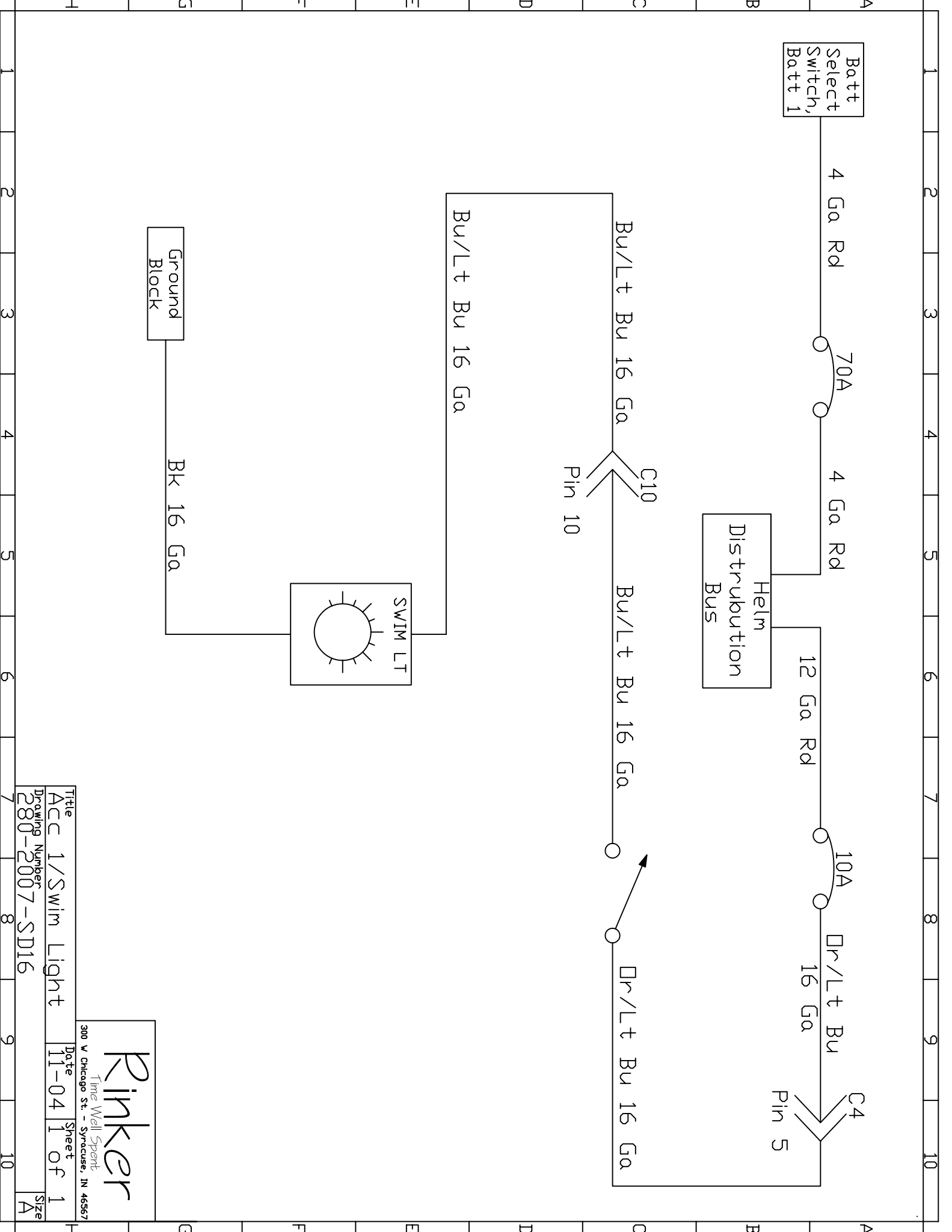

Title
 Acc 1/Swim Light
 Drawing Number
 280-2007-SD16

Date
 11-04
 Sheet
 1 of 1
 Size
 A

Rinker
 Time Well Spent
 300 V Chicago St. - Syracuse, IN 46567

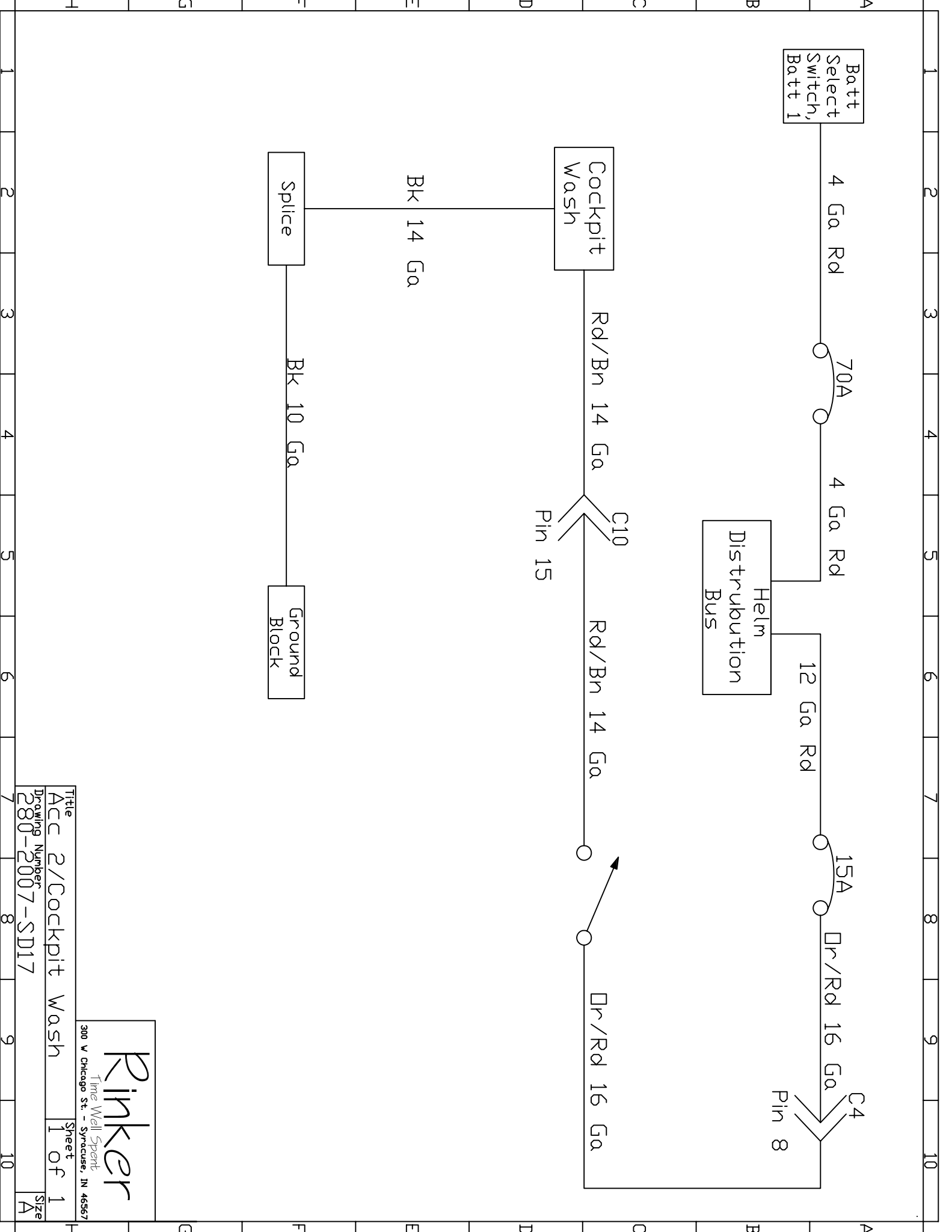

Title		Acc 2/Cockpit Wash	
Drawing Number		280-2007-SD17	
Sheet	1	of	1
Size	A		

Rinker
 Time Well Spent
 300 W Chicago St. - Syracuse, IN 46567

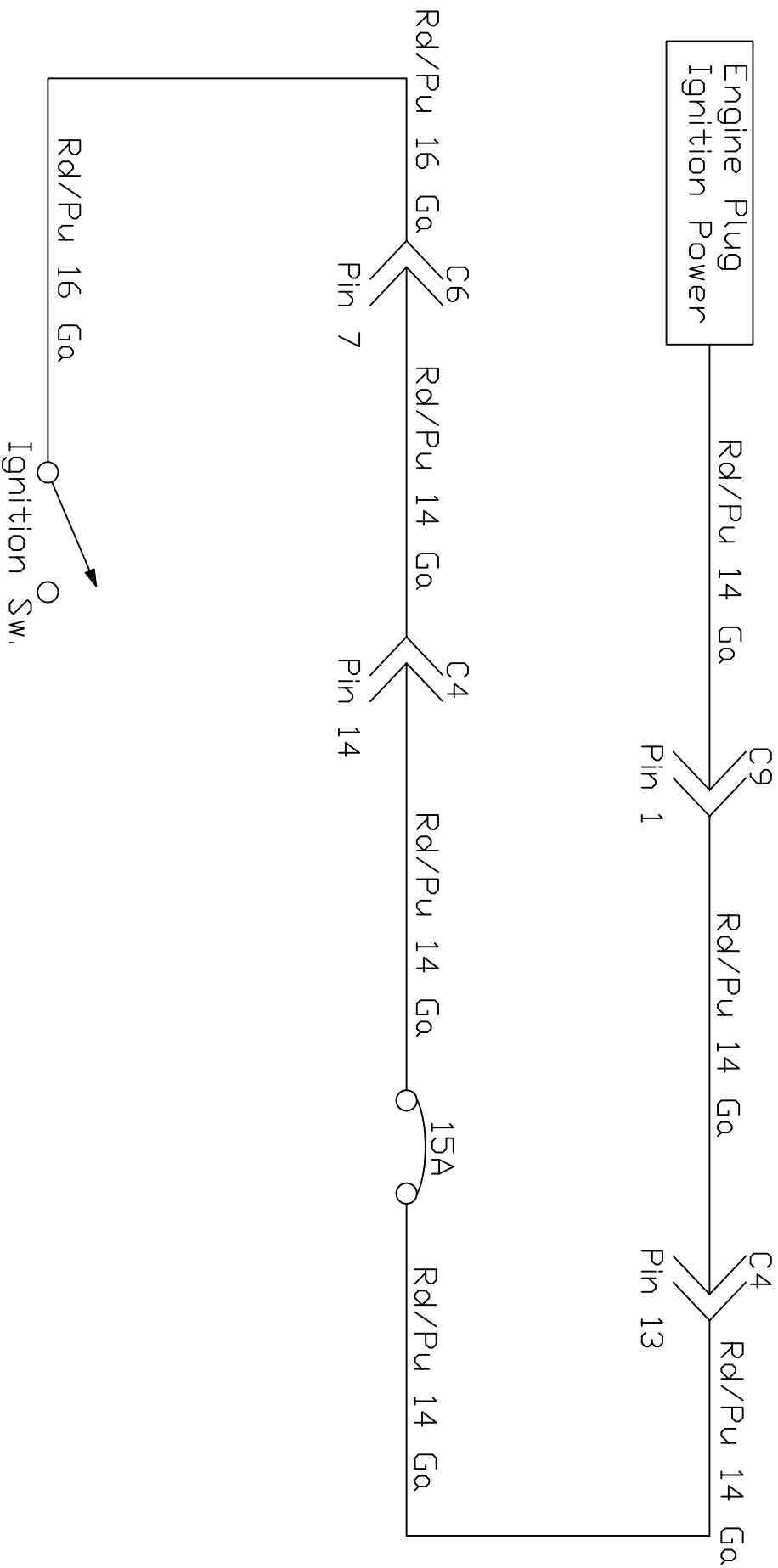

Title
Ignition
Drawing Number
280-2007-SD18

Date
11-04
Sheet
1 of 1

Rinker
Time Well Spent
300 V Chicago St. - Syracuse, IN 46567

Size
A

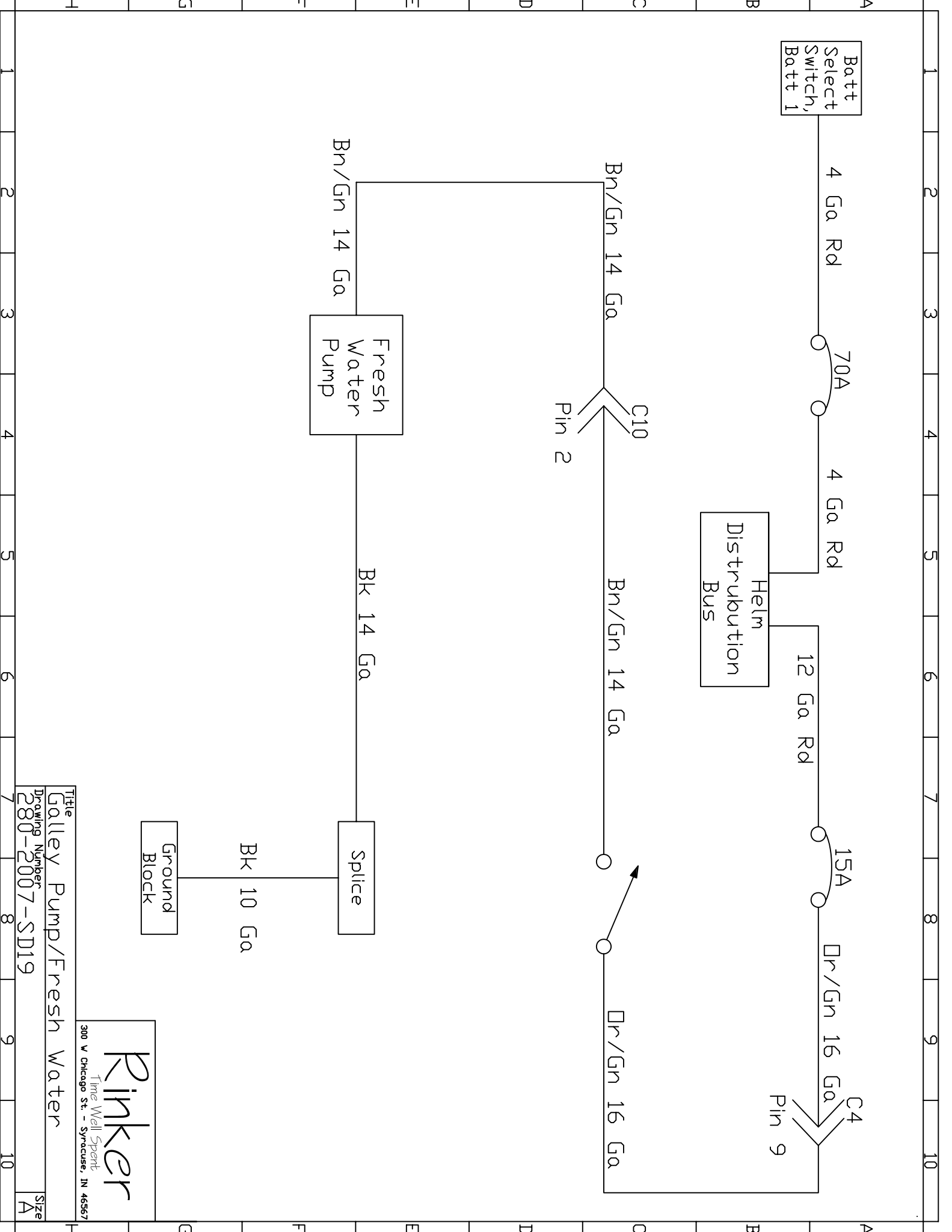

Batt Select Switch, Batt 1

4 Ga Rd

70A

4 Ga Rd

Helm Distribution Bus

12 Ga Rd

15A

Dr/Gn 16 Ga

C4
Pin 9

Bn/Gn 14 Ga

C10

Pin 2

Bn/Gn 14 Ga

Bn/Gn 14 Ga

Fresh Water Pump

BK 14 Ga

Splice

BK 10 Ga

Ground Block

Dr/Gn 16 Ga

Rinker
Time Well Spent
300 W Chicago St. - Syracuse, IN 46567

Title
Galley Pump/Fresh Water
Drawing Number
280-2007-SD19

Size
A

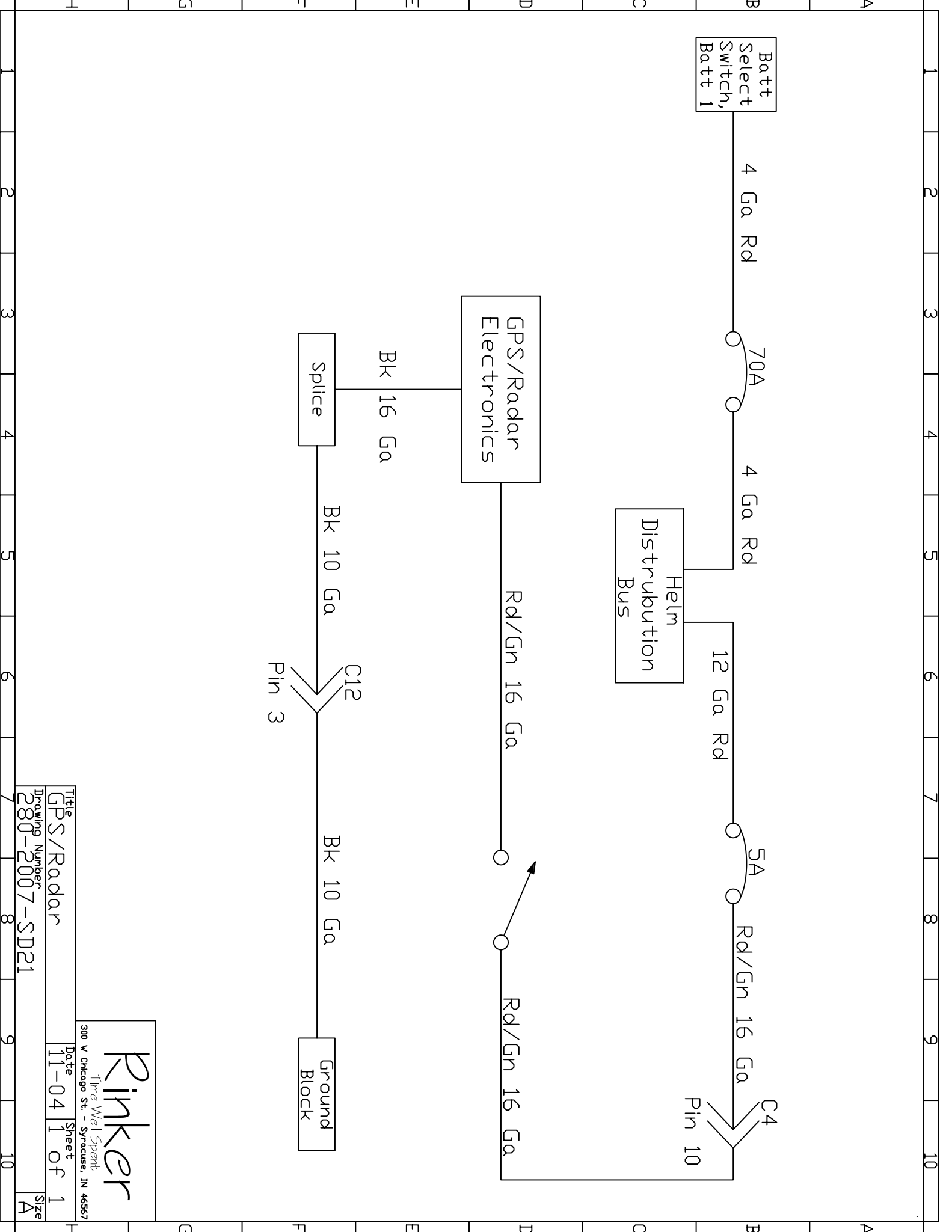

Title	GPS/Radar
Drawing Number	280-2007-SD21
Date	11-04
Sheet	1 of 1
Size	A

Rinker
 Time Well Spent
 300 W Chicago St. - Syracuse, IN 46567

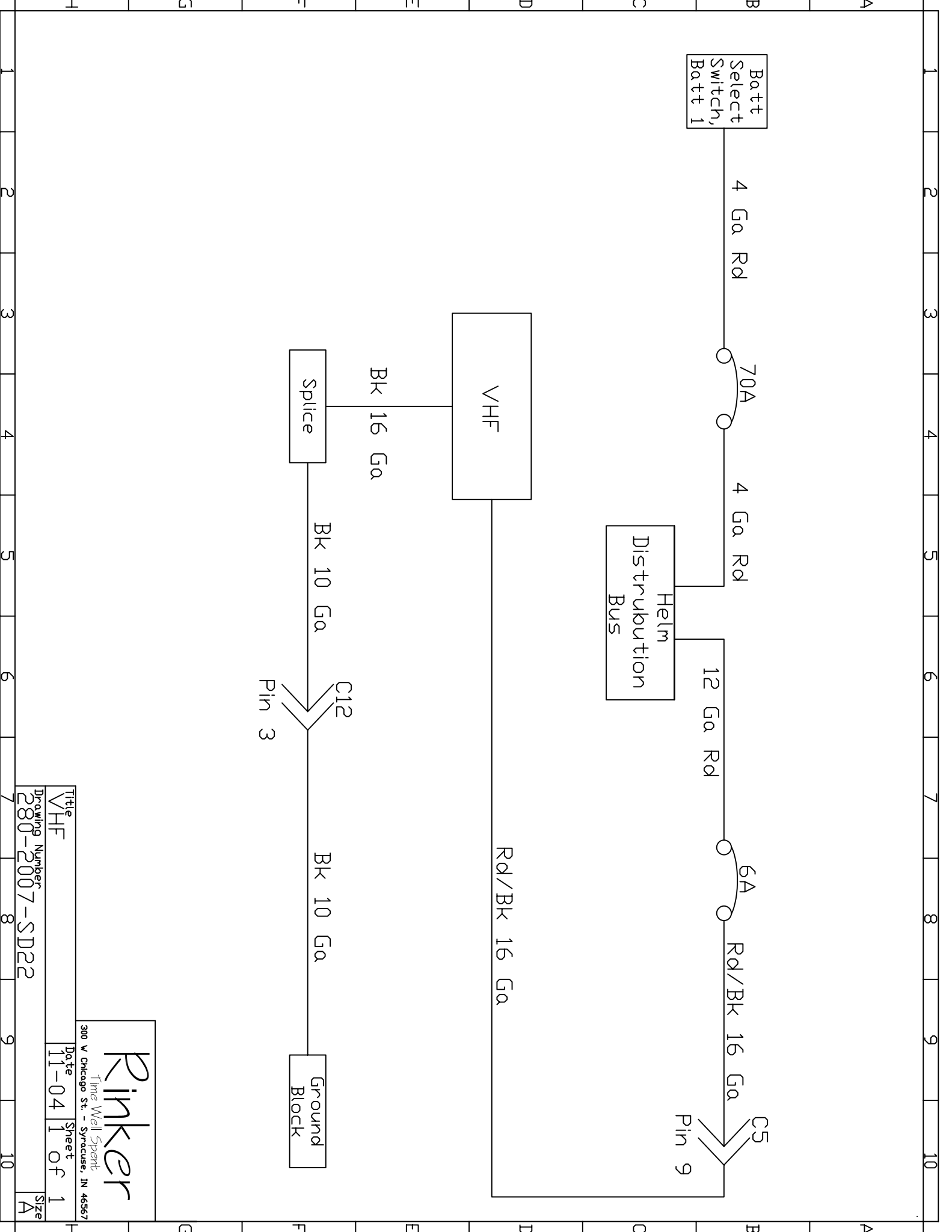

Helm
Distribution
Bus

Batt
Select
Switch,
Batt 1

VHF

Splice

Ground
Block

Rinker
Time Well Spent
300 V Chicago St. - Syracuse, IN 46567

Title	VHF
Drawing Number	280-2007-SD22
Date	11-04
Sheet	1 of 1
Size	A

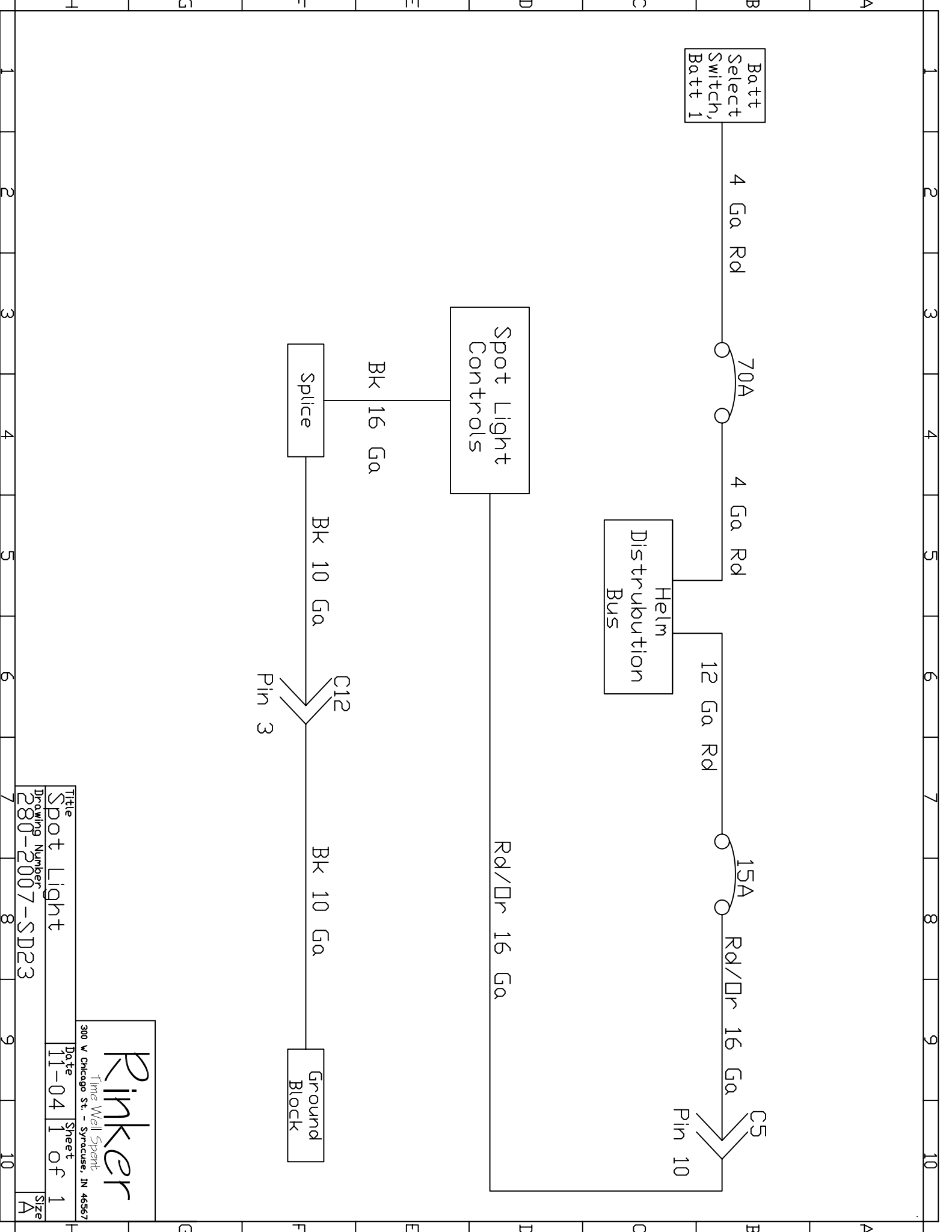

Batt Select Switch, Batt 1

4 Ga Rd

70A

4 Ga Rd

Helm Distribution Bus

12 Ga Rd

15A

Rd/Dn 16 Ga

C5
Pin 10

Spot Light Controls

Bk 16 Ga

Splice

Bk 10 Ga

C12
Pin 3

Bk 10 Ga

Ground Block

Rd/Dn 16 Ga

Rinker
Time Well Spent
300 V Chicago St. - Syracuse, IN 46567

Title	Spot Light	Date	11-04	Sheet	1 of 1	Size	A
Drawing Number	280-2007-SD23						

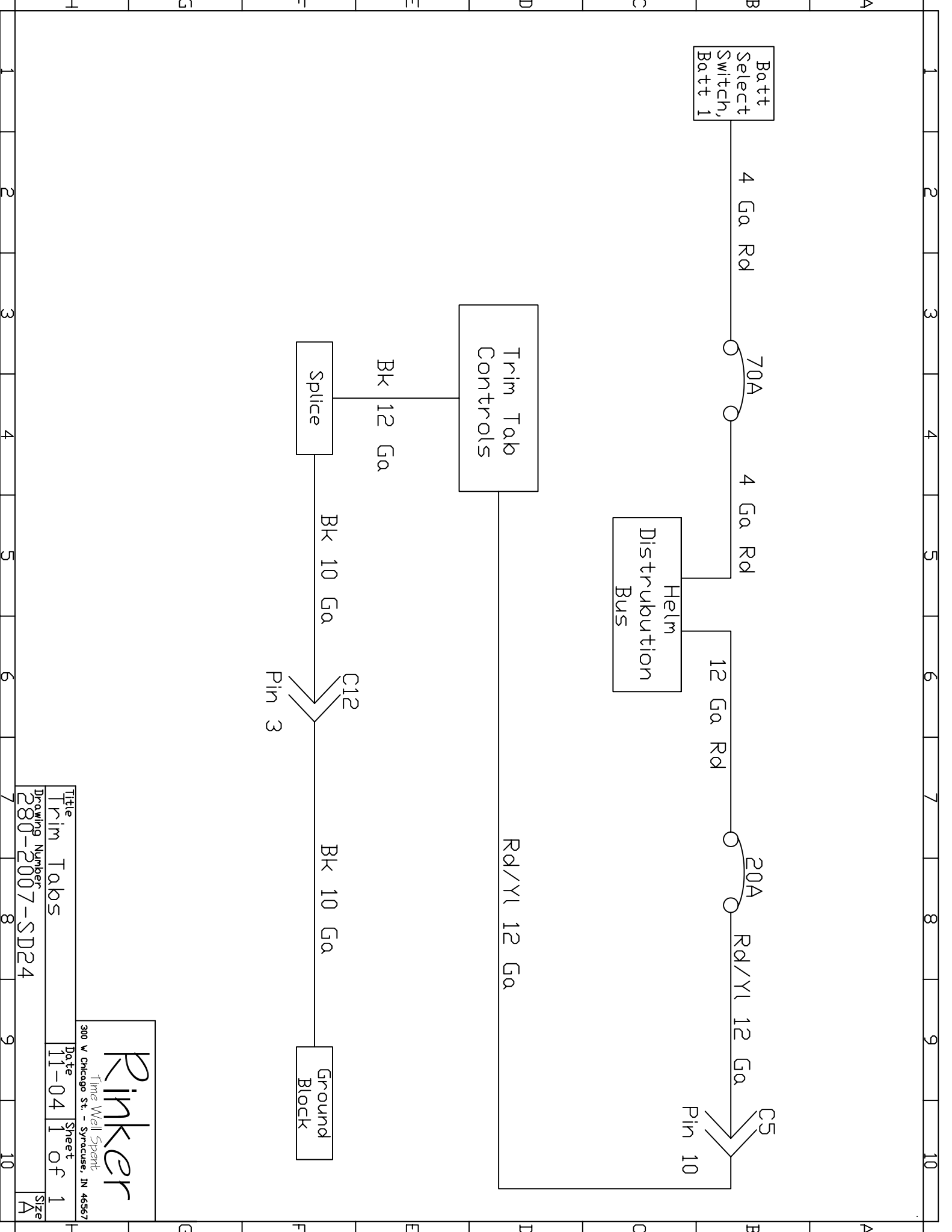

Rinker
 Time Well Spent
 300 W Chicago St. - Syracuse, IN 46567

Title	Trim Tabs	Date	11-04	Sheet	1	of	1	Size	A
Drawing Number	280-2007-SD24								

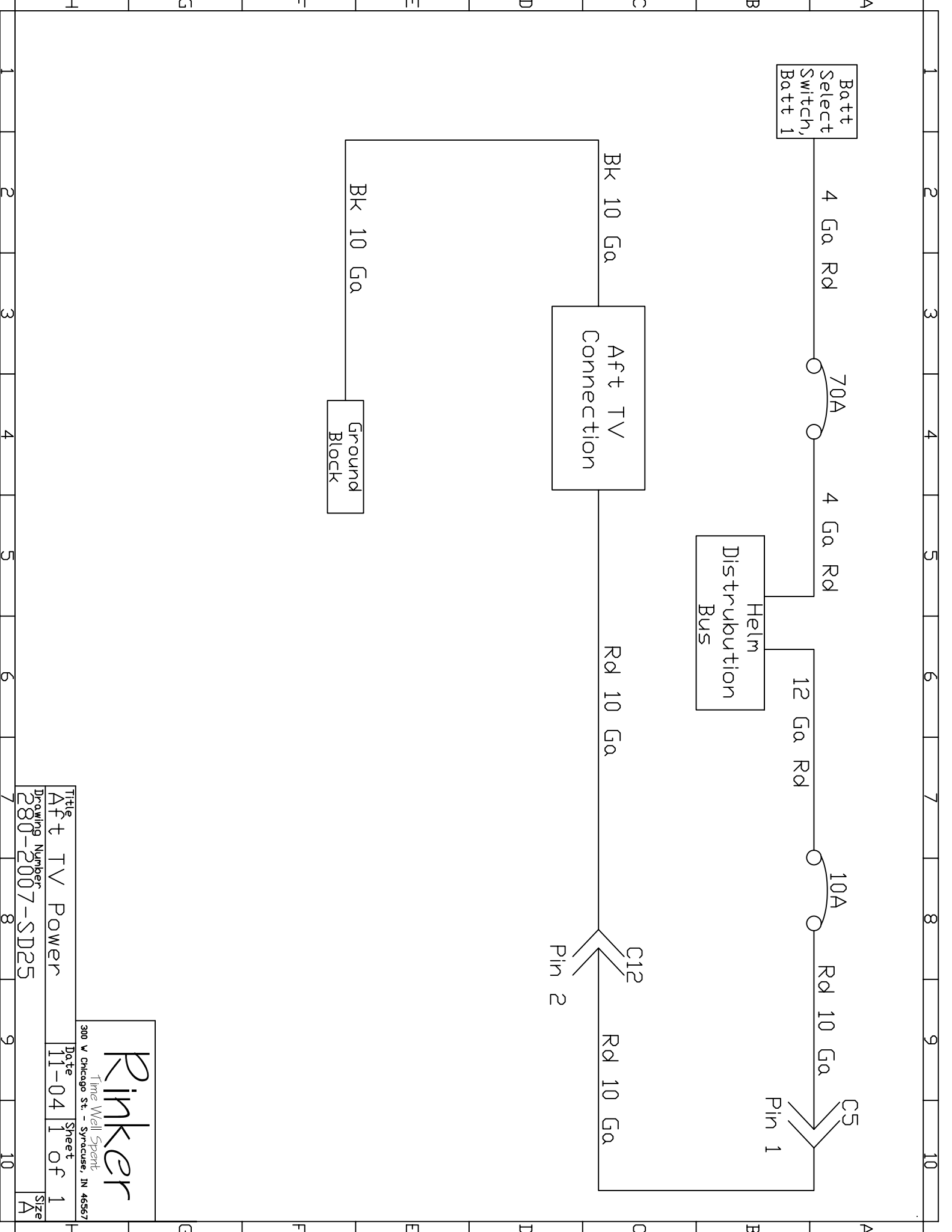

Title
Aft TV Power
Drawing Number
280-2007-SD25

Date
11-04
Sheet
1 of 1

Rinker
Time Well Spent
300 V Chicago St. - Syracuse, IN 46567

Size
A

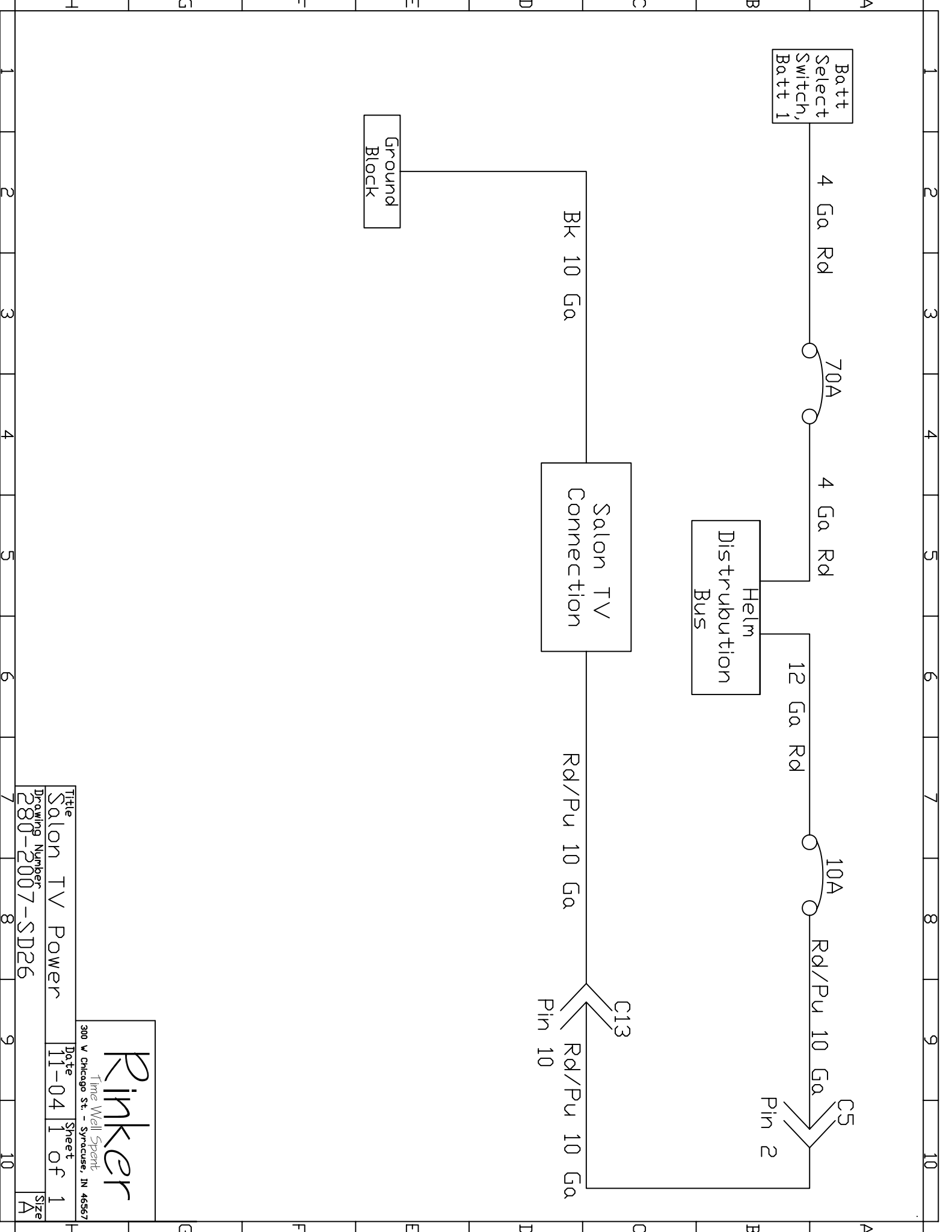

Batt Select Switch, Batt 1

4 Ga Rd

70A

4 Ga Rd

Helm Distribution Bus

12 Ga Rd

10A

Rd/Pu 10 Ga

Salon TV Connection

Ground Block

Bk 10 Ga

Rd/Pu 10 Ga

C13

Rd/Pu 10 Ga

Rd/Pu 10 Ga

C5

Pin 2

Pin 10

Rinker

300 W Chicago St. - Syracuse, IN 46567

Time Well Spent

Title
Salon TV Power
Drawing Number
280-2007-SD26

Date
11-04

Sheet
1 of 1

Size
A

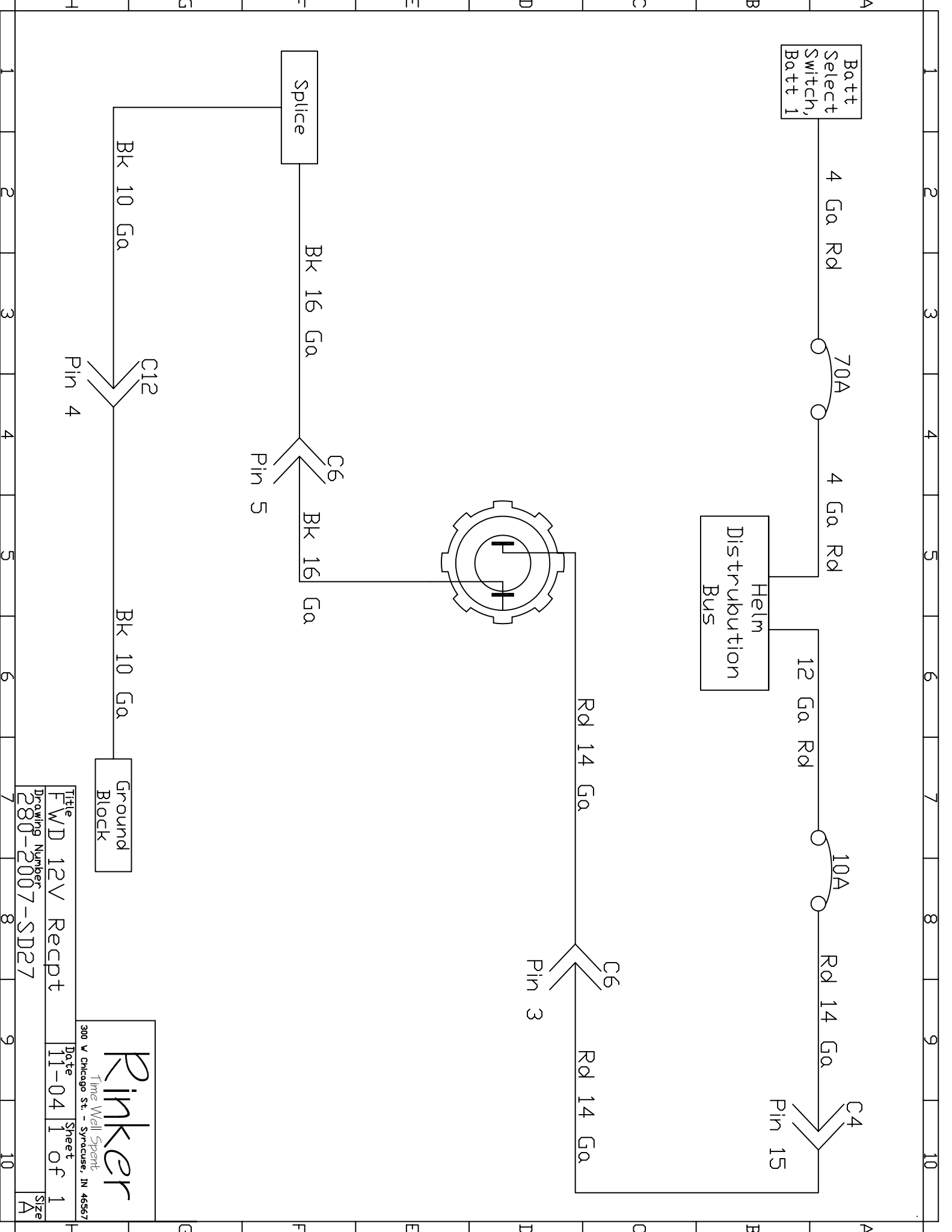

Title	F W/D 12V Recpt
Drawing Number	280-2007-SD27
Date	11-04
Sheet	1 of 1
Size	A

Rinker
 Time Well Spent
 300 V Chicago St. - Syracuse, IN 46567

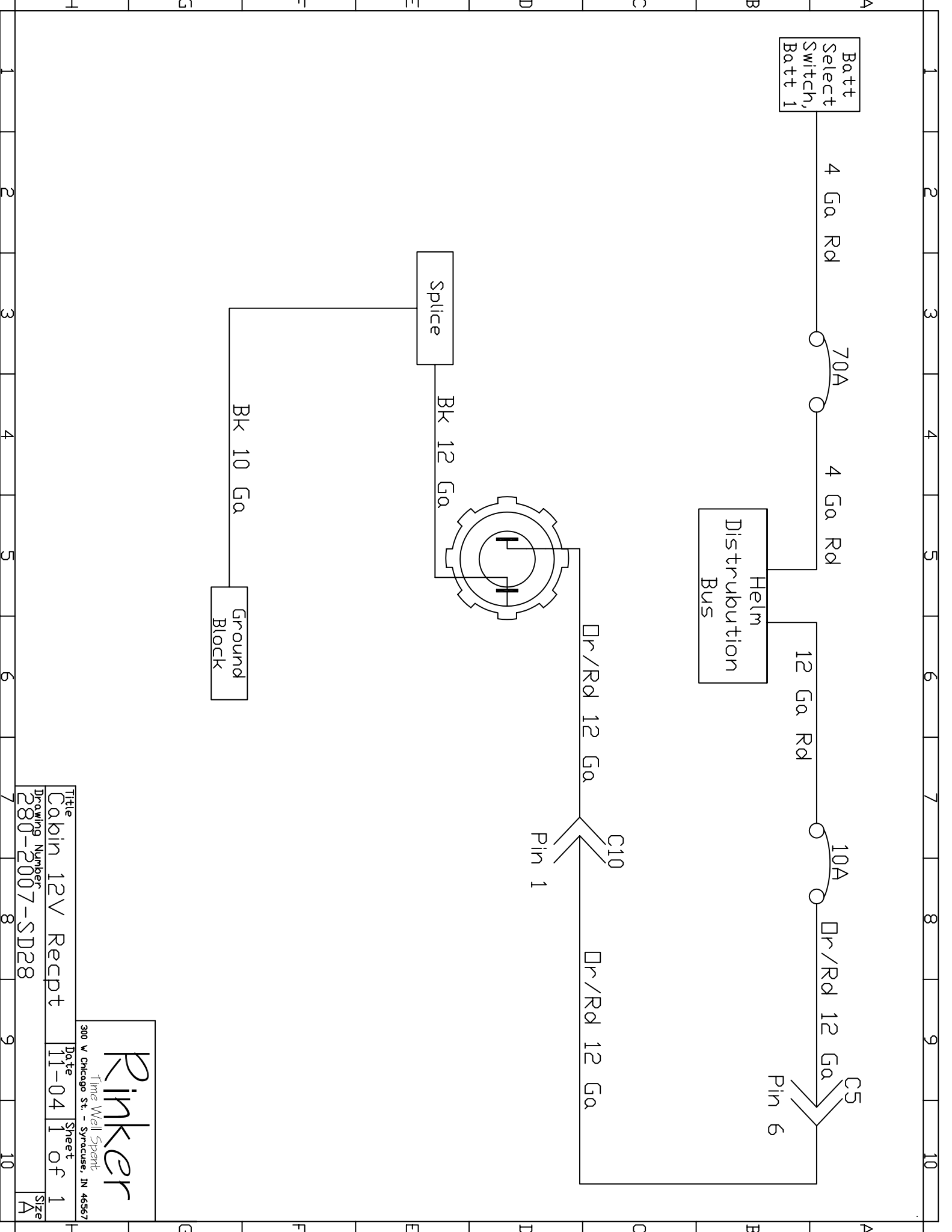

Title
Cabin 12V Recpt
Drawing Number
280-2007-SD28

Date
11-04
Sheet
1 of 1
Size
A

Rinker
Time Well Spent
300 V Chicago St. - Syracuse, IN 46567

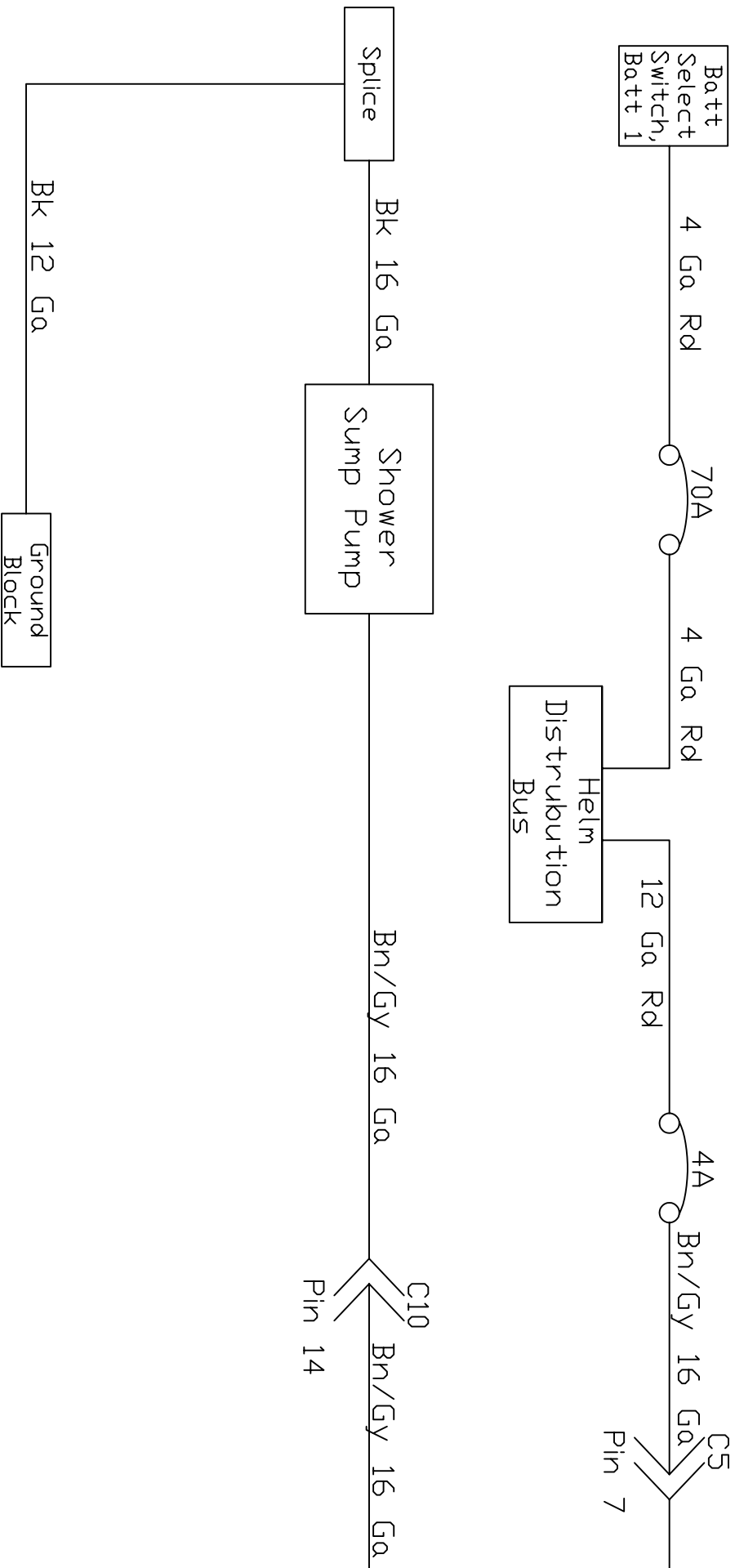

Helm
Distribution
Bus

Bat+t
Select
Switch,
Bat+t 1

Splice

Shower
Sump
Pump

Ground
Block

Rinker

300 W Chicago St. - Syracuse, IN 46567

Title	Shower Sump Pump	Date	11-04	Sheet	1 of 1	Size	A
Drawing Number	280-2007-SD29						

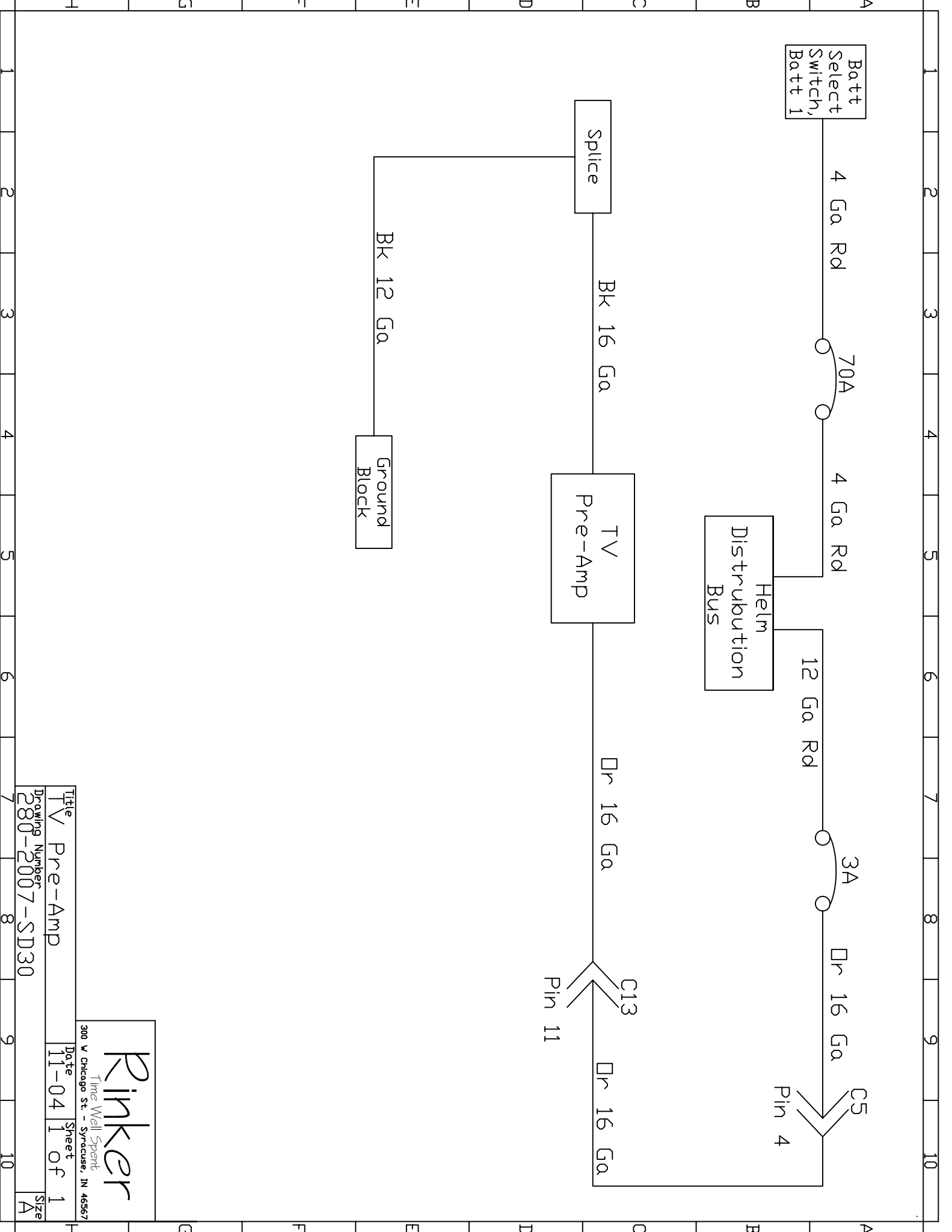

Title	TV Pre-Amp
Drawing Number	280-2007-SD30
Date	11-04
Sheet	1 of 1
Size	A

Rinker
 Time Well Spent
 300 V Chicago St. - Syracuse, IN 46567

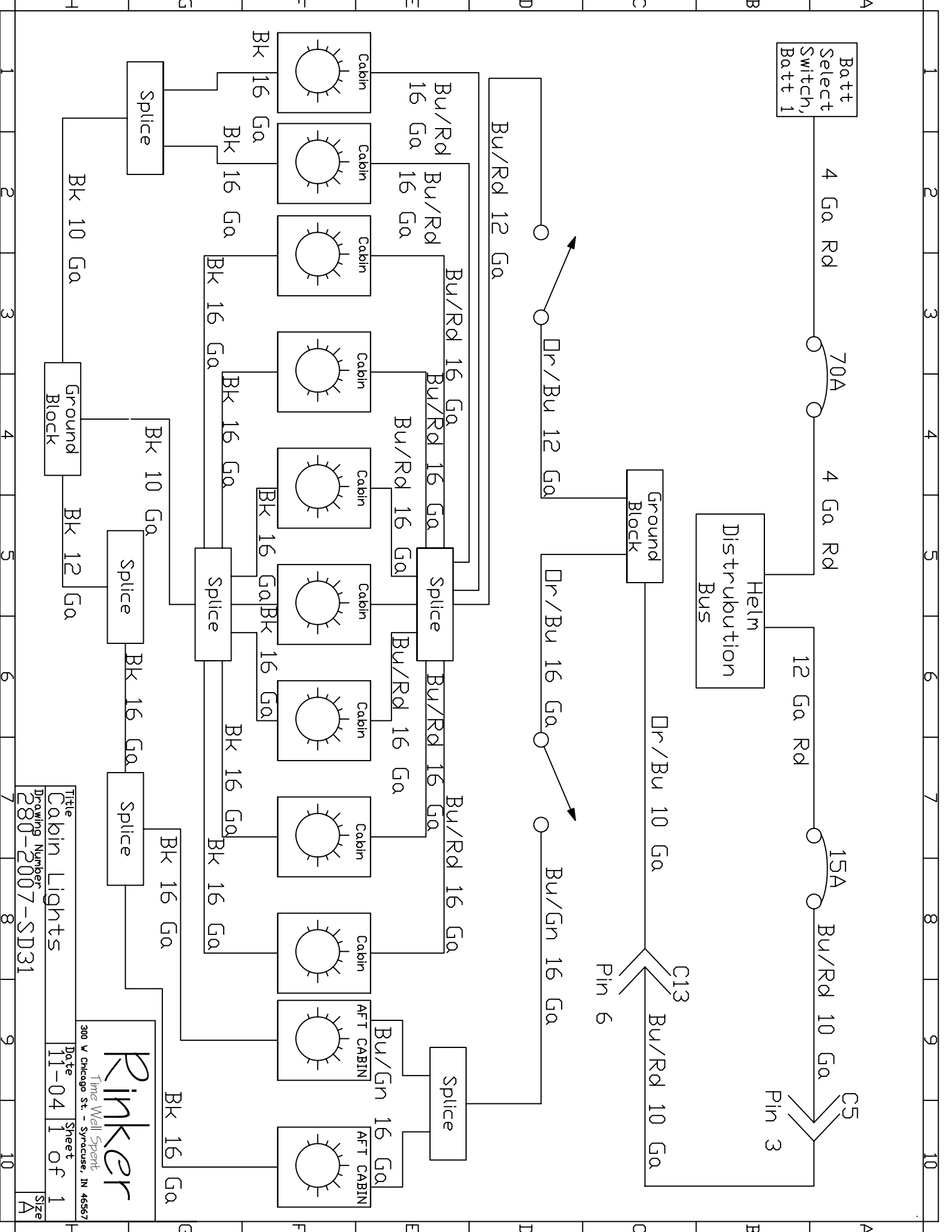

Title		Cabin Lights	
Drawing Number		280-2007-SD31	
Date	11-04	Sheet	1 of 1
Rinker <small>Time Well Spent</small> 300 V Chicago St. - Syracuse, IN 46567			
Size		A	

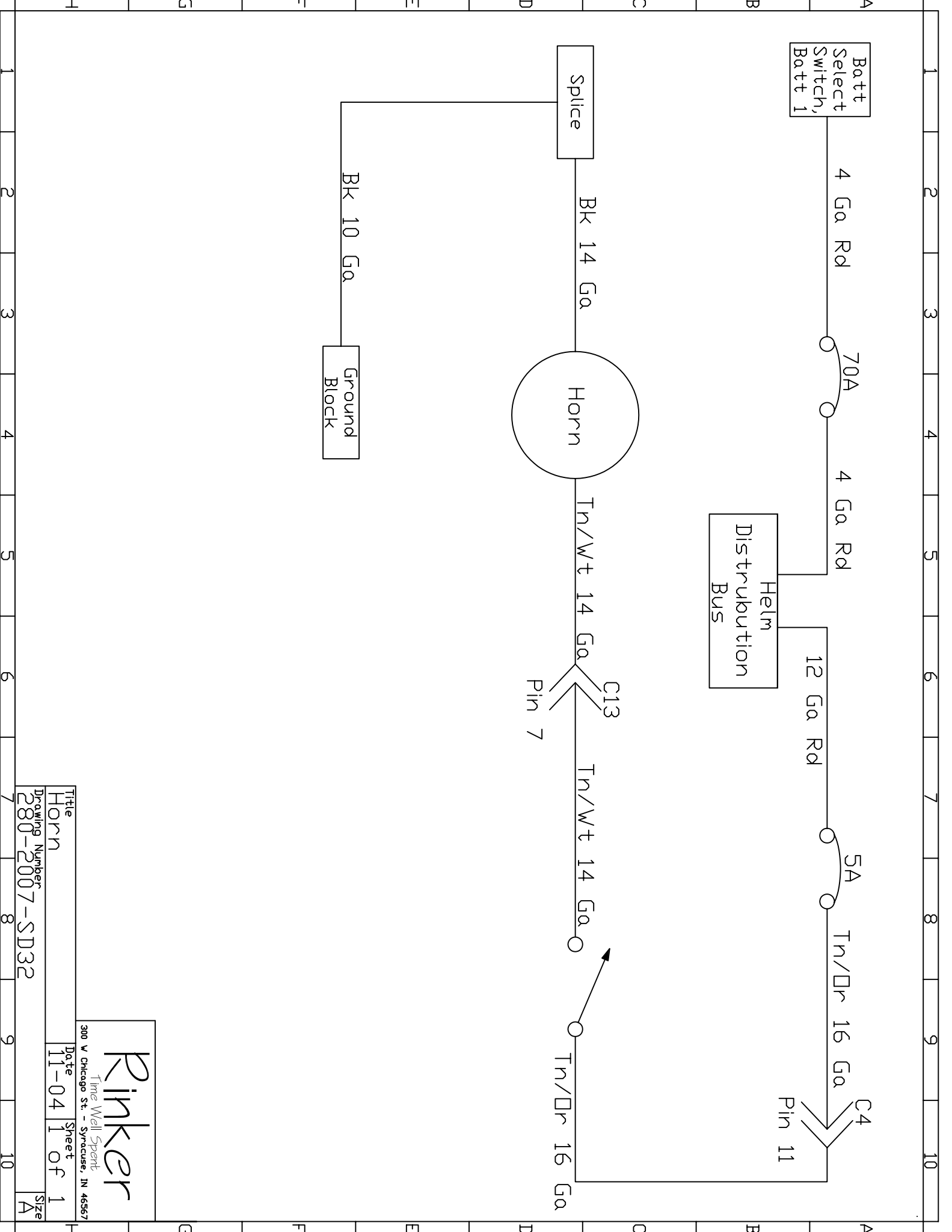

Title	Horn
Drawing Number	280-2007-SD32

Rinker
 Time Well Spent
 300 V Chicago St. - Syracuse, IN 46567

Date	11-04	Sheet	1 of 1
Size	A		

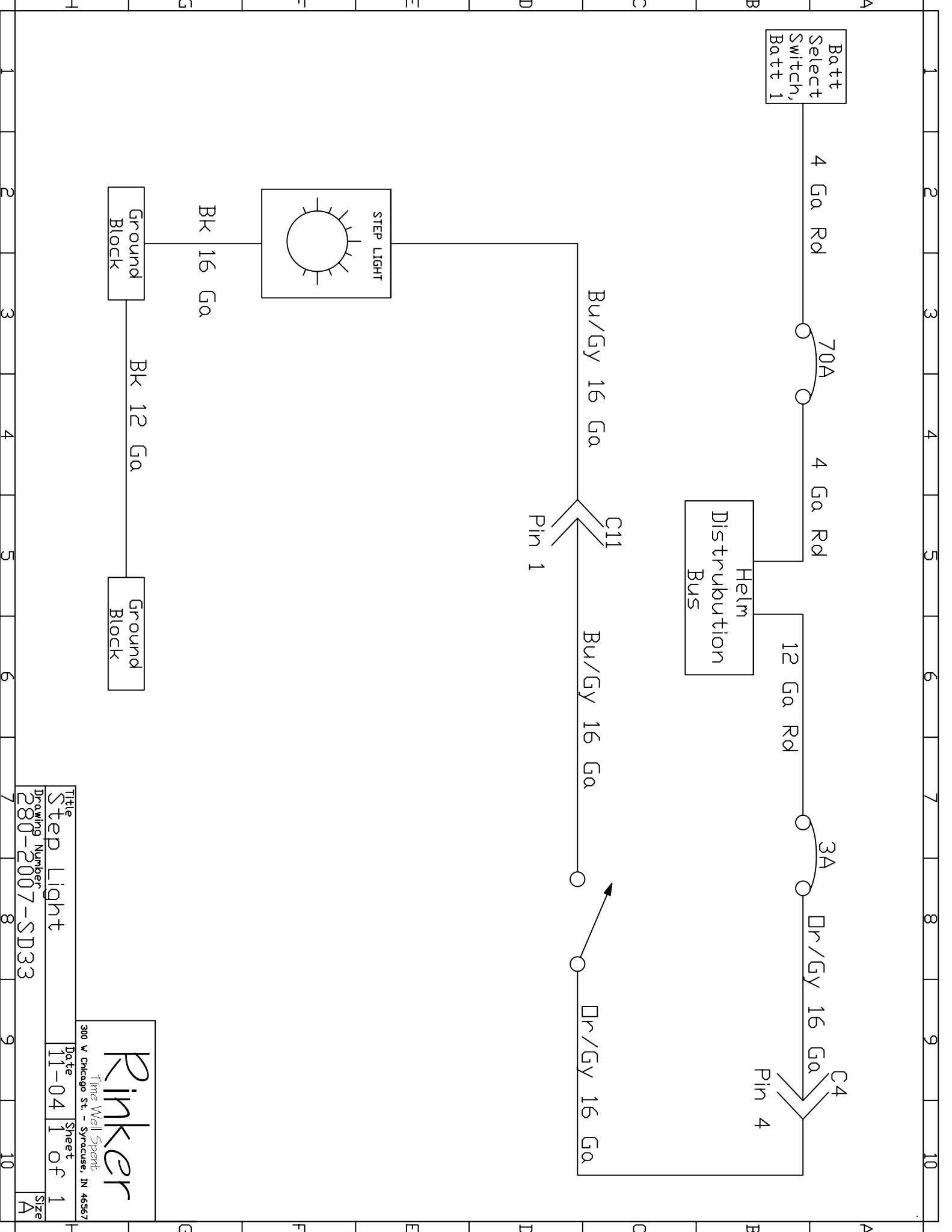

Title		Step Light	
Drawing Number		280-2007-SD33	
Date	11-04	Sheet	1 of 1
300 V Chicago St. - Syracuse, IN 46567		Rinker	
Time Well Spent		Rinker	
Size		A	

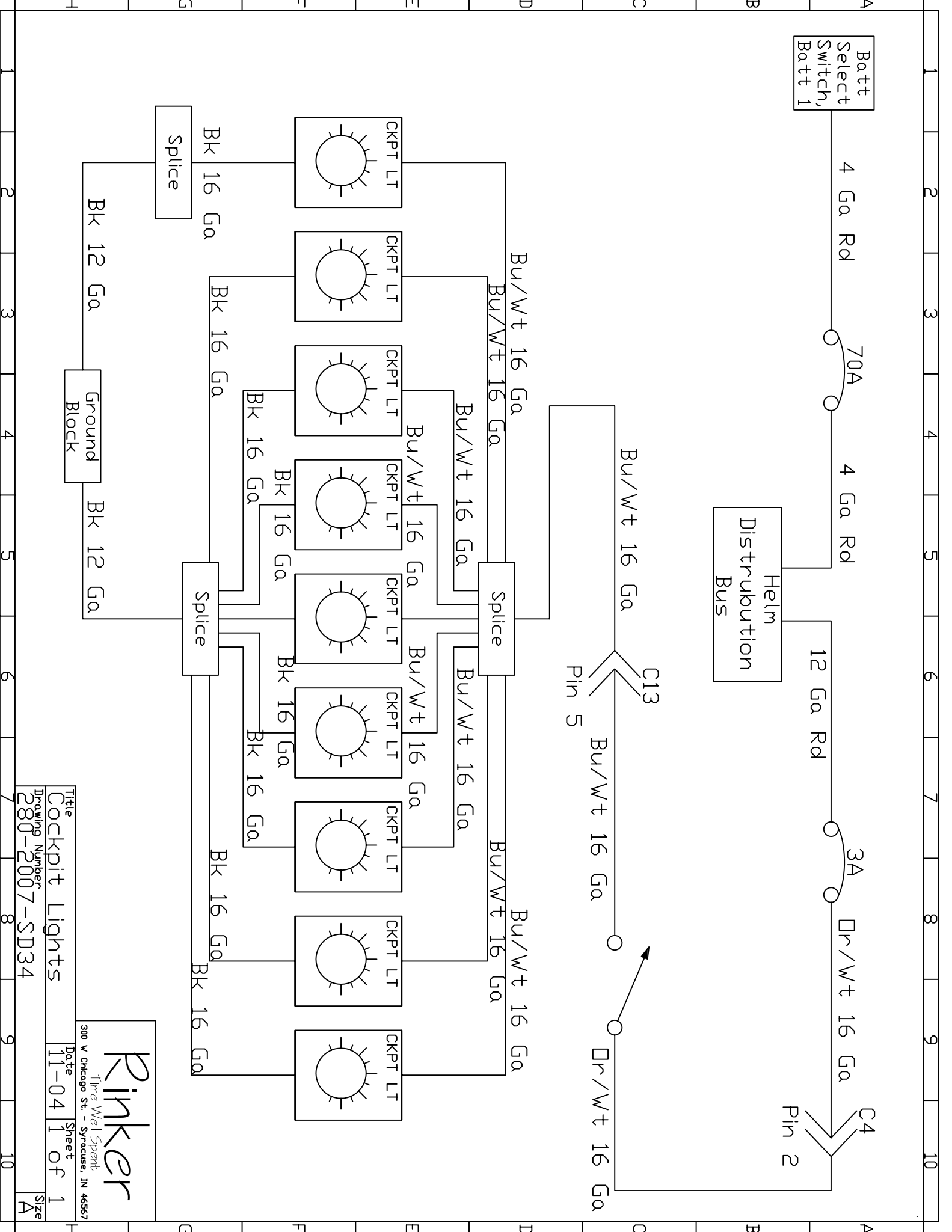

Title		Cockpit Lights	
Drawing Number		280-2007-SD34	
Date	11-04	Sheet	1 of 1
<small>Time Well Spent. 300 V Chicago St. - Syracuse, IN 46567</small>			

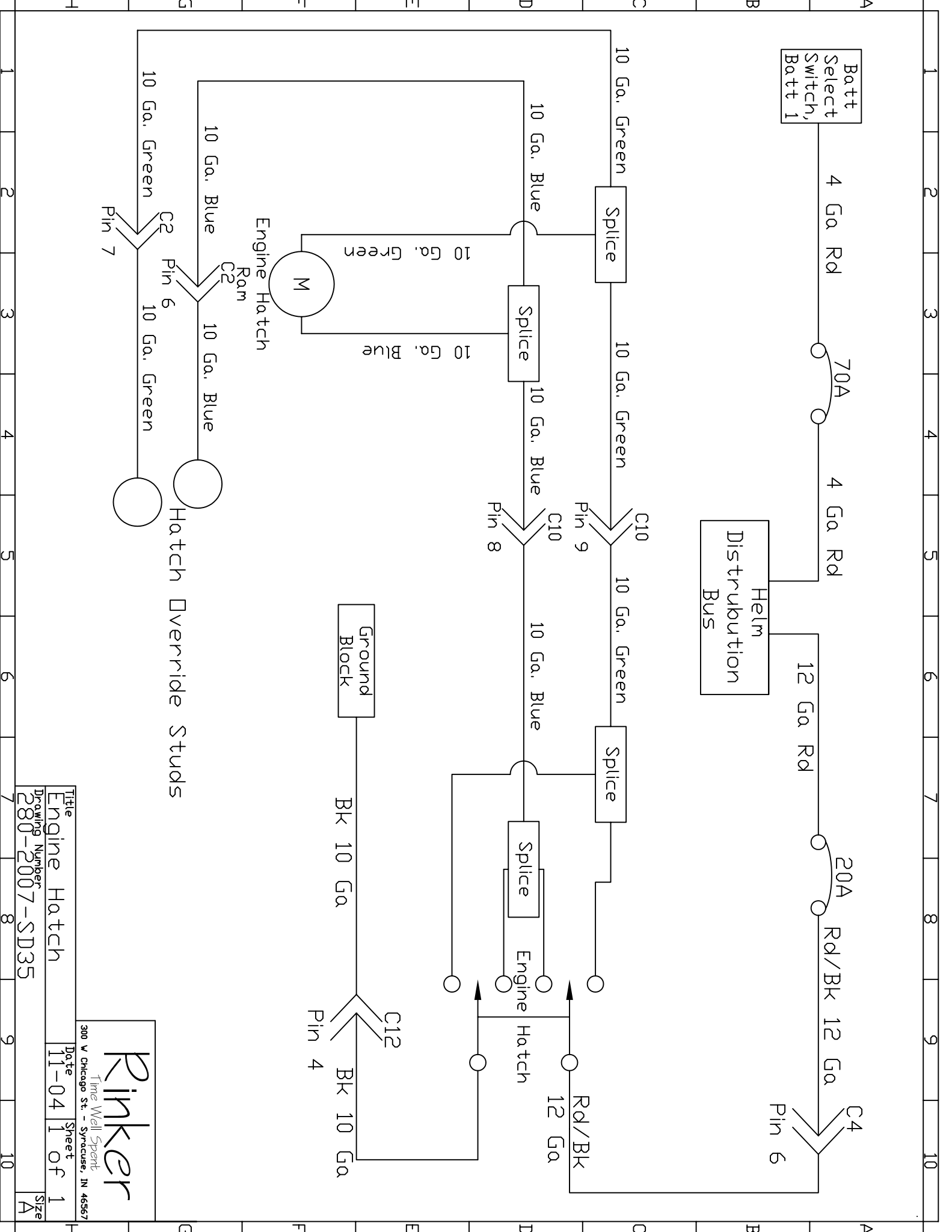

Batt Select Switch, Batt 1

4 Ga Rd

70A

4 Ga Rd

Helm Distribution Bus

12 Ga Rd

20A

Rd/Bk 12 Ga

Pin 6

10 Ga. Green

Splice

10 Ga. Green

10 Ga. Blue

Splice

10 Ga. Blue

10 Ga. Green

10 Ga. Blue

Engine Hatch

Ram

10 Ga. Blue

10 Ga. Blue

10 Ga. Green

Pin 7

Hatch Override Studs

Pin 6

C10

Pin 9

C10

Pin 8

Splice

Splice

Engine Hatch

12 Ga Rd/Bk

Ground Block

Bk 10 Ga

Pin 4

Bk 10 Ga

Title
Engine Hatch
Drawing Number
280-2007-SD35

Rinker
Time Well Spent
300 V Chicago St. - Syracuse, IN 45667

Date
11-04
Sheet
1 of 1
Size
A

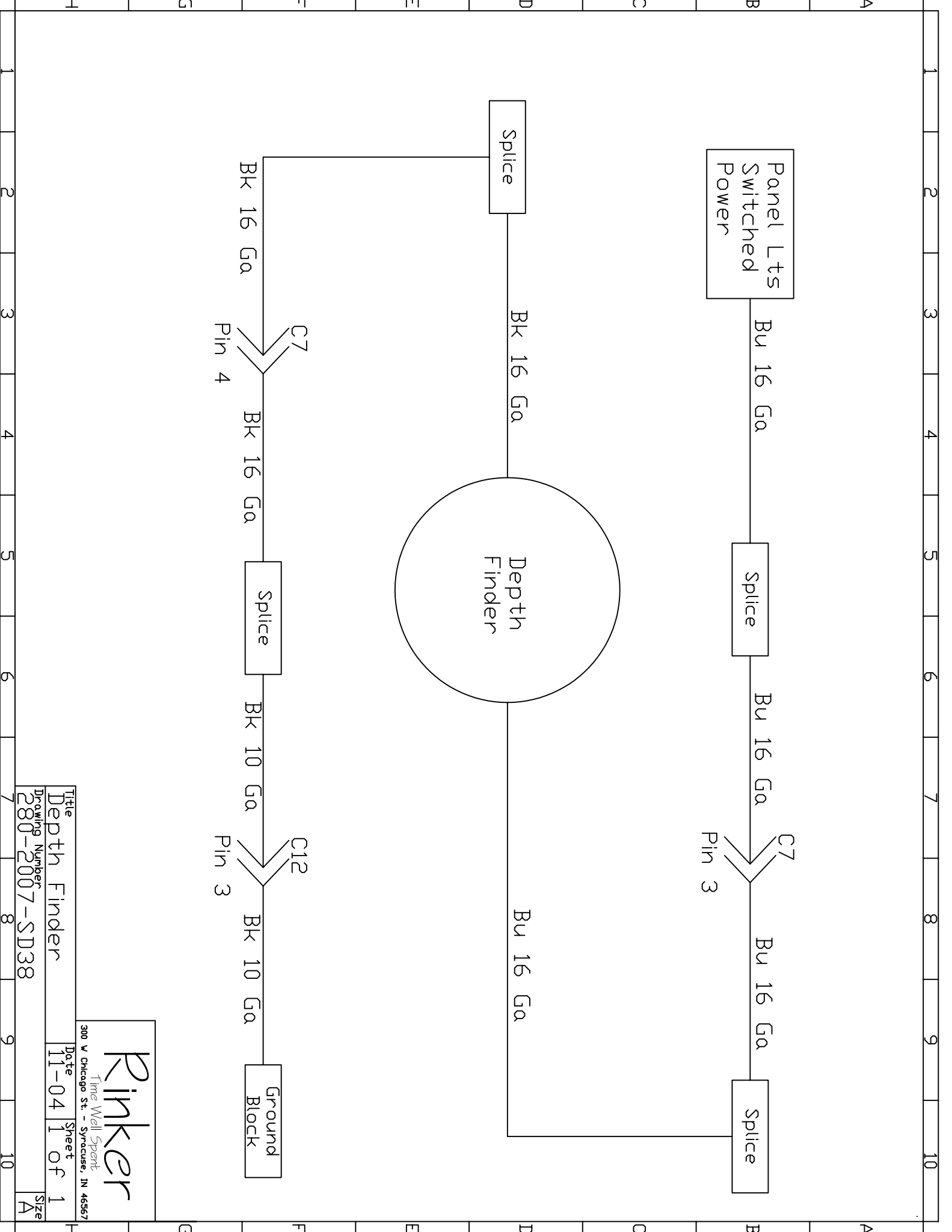

Panel Lts
Switched
Power

Bu 16 Ga

Splice

Bu 16 Ga

C7
Pin 3

Bu 16 Ga

Splice

Splice

Bk 16 Ga

Depth
Finder

Bu 16 Ga

Bk 16 Ga

C7
Pin 4

Bk 16 Ga

Splice

Bk 10 Ga

C12
Pin 3

Bk 10 Ga

Ground
Block

Rinker

Time Well Spent
300 V Chicago St. - Syracuse, IN 46567

Title	Depth Finder	Date	11-04	Sheet	1 of 1	Size	A
Drawing Number	280-2007-SD38						

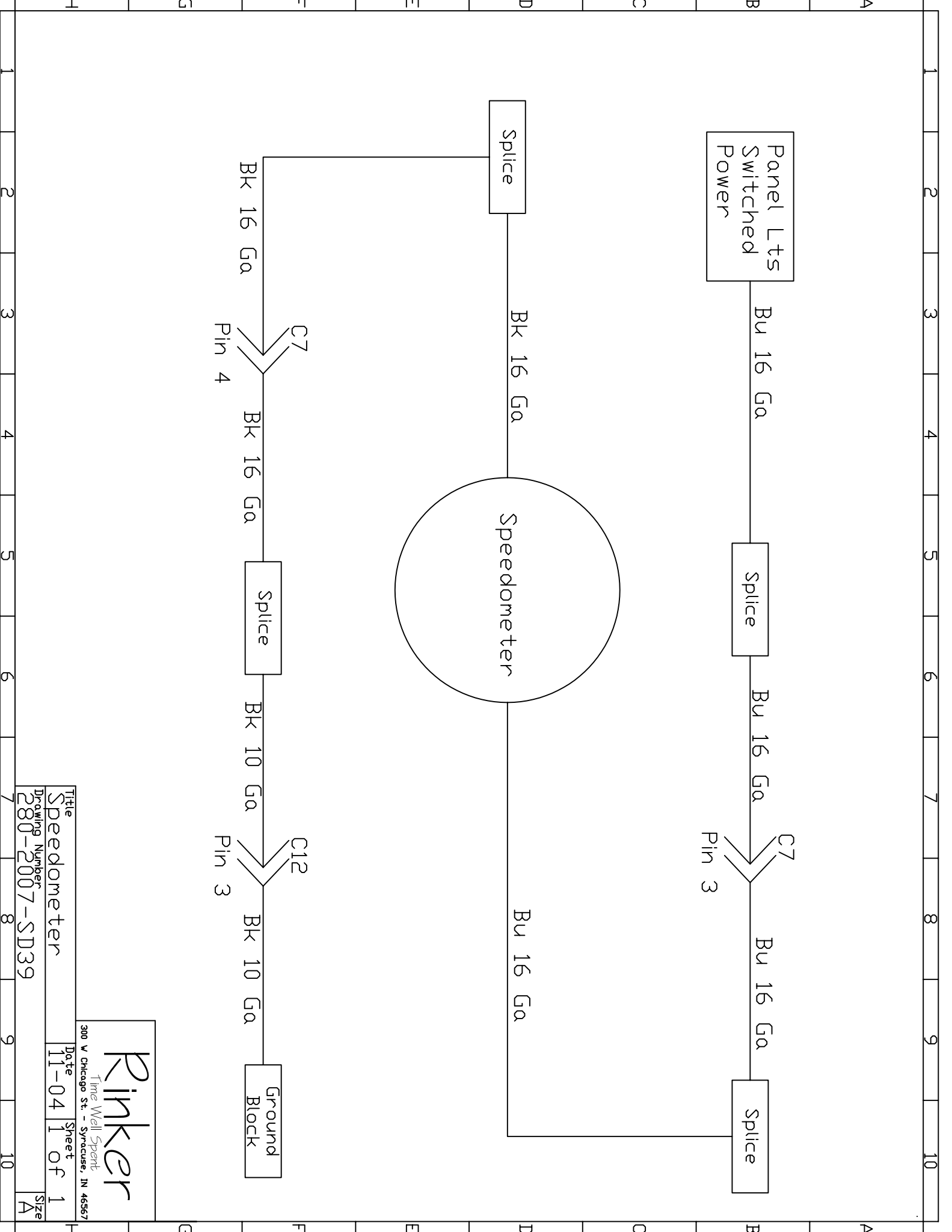

Panel Lts
Switched
Power

Bu 16 Ga

Splice

Bu 16 Ga

C7
Pin 3

Bu 16 Ga

Splice

Splice

Bk 16 Ga

Speedometer

Bu 16 Ga

Bk 16 Ga

C7
Pin 4

Bk 16 Ga

Splice

Bk 10 Ga

C12
Pin 3

Bk 10 Ga

Ground
Block

Rinker

Time Well Spent
300 V Chicago St. - Syracuse, IN 46567

Title	Speedometer	Date	11-04	Sheet	1 of 1	Size	A
Drawing Number	280-2007-SD39						

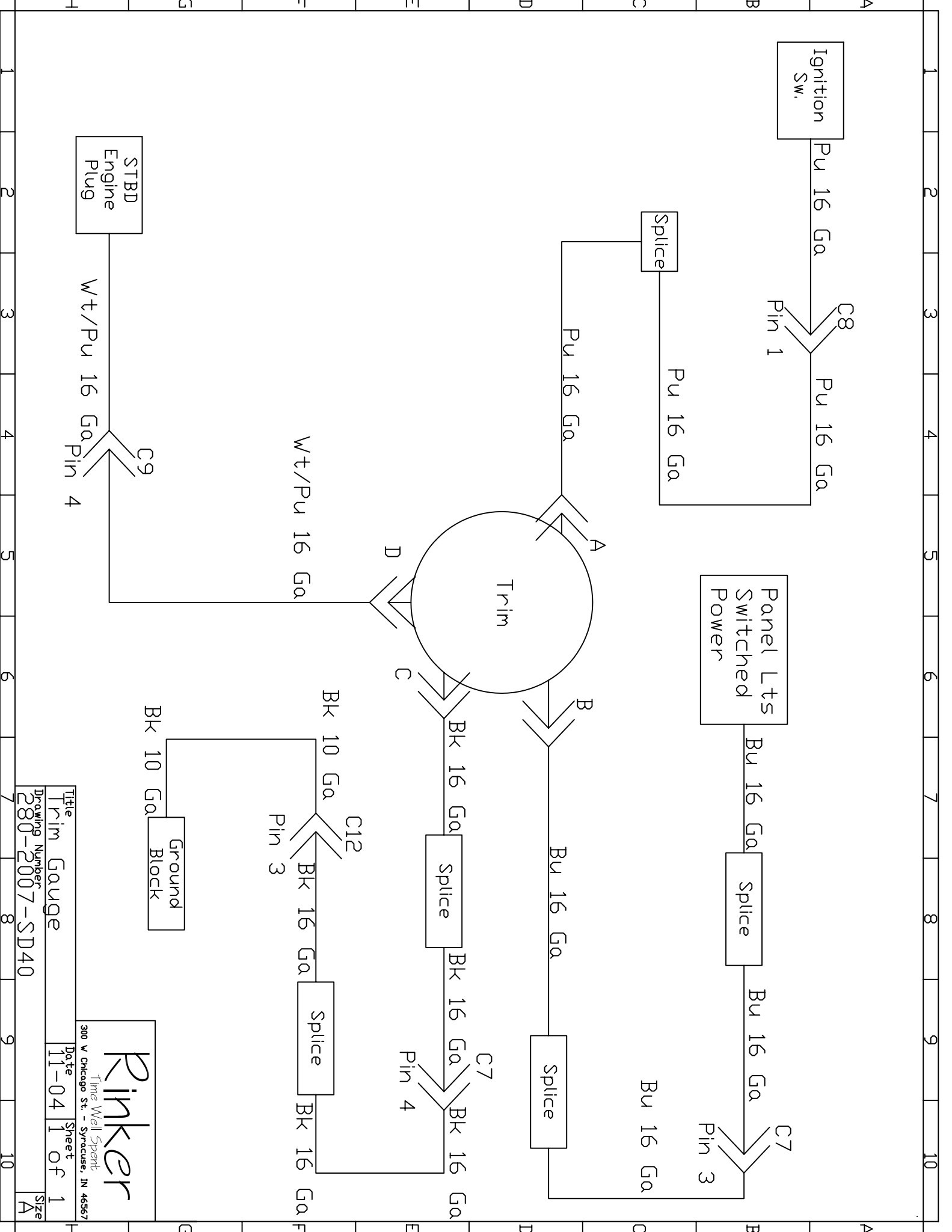

Title
Trim Gauge
Drawing Number
280-2007-SD40

Date
11-04
Sheet
1 of 1
Size
A

Rinker
Time Well Spent
300 V Chicago St. - Syracuse, IN 46567

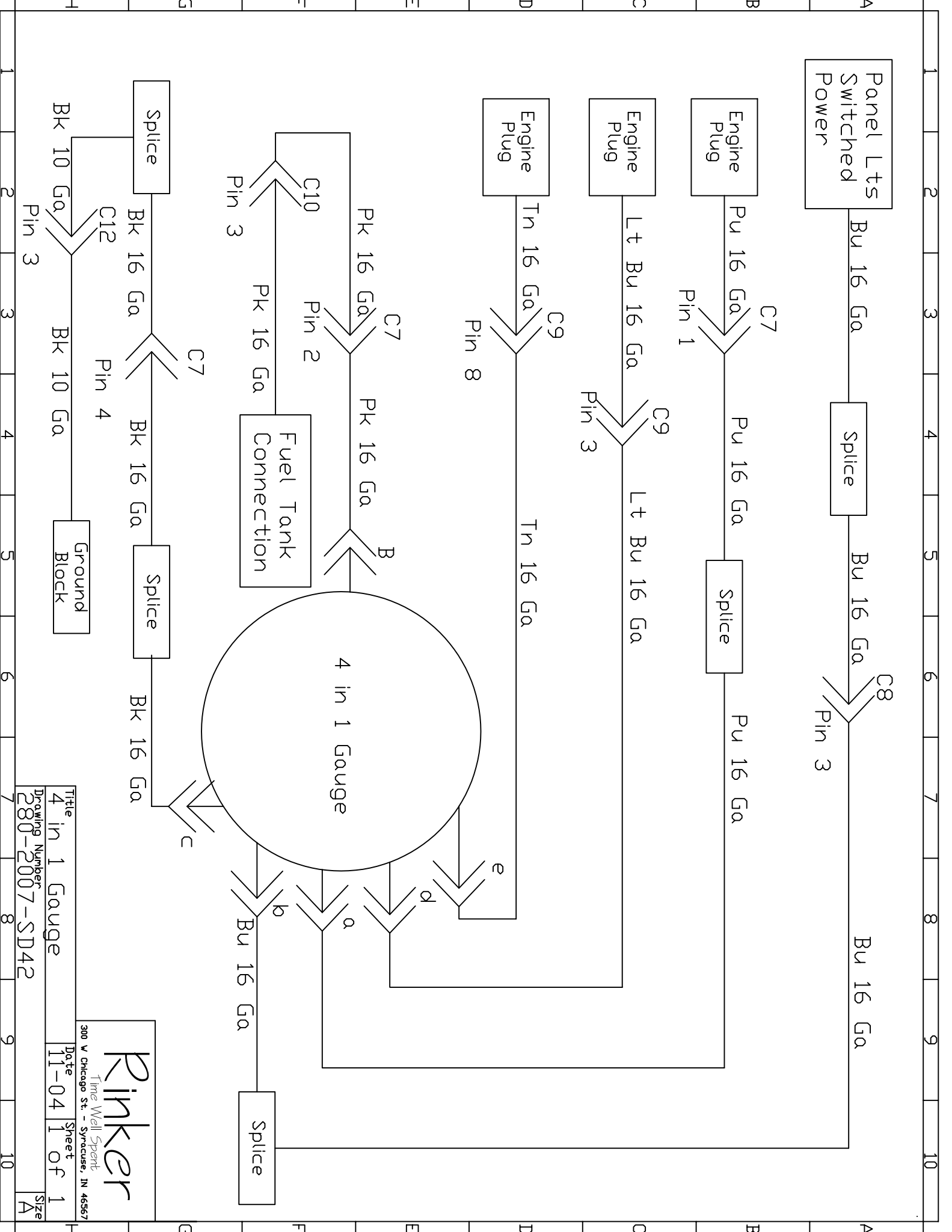

Title
 4 in 1 Gauge
 Drawing Number
 280-2007-SD42

Date
 11-04
 Sheet
 1 of 1

300 V Chicago St. - Syracuse, IN 46567
Rinker
 Time Well Spent

Size
 A